

## AMG ELM-Q2266

**Weidmüller Interface GmbH & Co. KG**

Klingenbergstraße 26

D-32758 Detmold

Germany

www.weidmueller.com

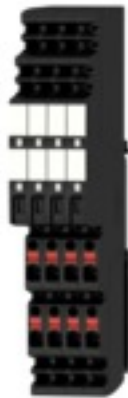

Similar to illustration

Efficient machine and facility operation calls for fail-safe and maintenance-friendly control voltage distribution that can be installed in a time and space-saving manner. With the new maxGUARD system, the terminal blocks (previously installed separately) for distributing potential to the outputs of the electronic load monitors become an integral part of a 24 V DC control voltage distribution system.

The innovative combination of load monitoring and potential distribution saves time during installation, increases safety against failure and reduces the amount of space required on the terminal rail by 50%.

### General ordering data

Version	Electronic load monitoring, 24 V DC
Order No.	<a href="#">2081820000</a>
Type	AMG ELM-Q2266
GTIN (EAN)	4050118419436
Qty.	1 pc(s).
Delivery status	<b>This article will no longer be available in the future.</b>
Available until	2022-05-19

Creation date December 5, 2023 8:26:41 AM CET

Catalogue status 24.11.2023 / We reserve the right to make technical changes.

## AMG ELM-Q2266

**Weidmüller Interface GmbH & Co. KG**

Klingenbergstraße 26

D-32758 Detmold

Germany

www.weidmueller.com

## Technical data

### Dimensions and weights

Depth	96.5 mm	Depth (inches)	3.799 inch
Height	125 mm	Height (inches)	4.921 inch
Width	24.4 mm	Width (inches)	0.961 inch
Net weight	104 g		

### Temperatures

Storage temperature	-40 °C...85 °C	Operating temperature	-25 °C...55 °C
---------------------	----------------	-----------------------	----------------

### Input

Current consumption (full load)	4x I <sub>OUT</sub> +45 mA	Current consumption (idle)	35 mA
DC input voltage range	18...30 V DC	Input fuse (internal)	Yes
Rated input voltage	24 V DC	Surge protection	Suppressor diode
max. admissible residual ripple at the input	100 mVpp		

### Output

Adjustable rated current	No	Capacitive load	min. 10,000 µF
Connection system	PUSH IN	Surge protection	Suppressor diode
Switch-on delay	1 s	Triggering characteristic	see characteristic curve

### General data

Conformal coating	No	Function key	Activation time < 3s, Reset, ON
Protection degree	IP20	Relay to activate the output	No
Surge voltage category	III		

### Insulation coordination

Surge voltage category	III
------------------------	-----

### Connection data (output)

Conductor cross-section, AWG/kcmil , max.	12	Conductor cross-section, AWG/kcmil , min.	26
Conductor cross-section, flexible , max.	2.5 mm <sup>2</sup>	Conductor cross-section, flexible , min.	0.14 mm <sup>2</sup>
Conductor cross-section, rigid , max.	2.5 mm <sup>2</sup>	Conductor cross-section, rigid , min.	0.14 mm <sup>2</sup>
Connection system	PUSH IN		

### Signalling

LED green	Red LED	Load monitoring has disconnected, Load monitoring has triggered (flashing), Internal error (rapid flashing)
	Operation (failure-free)	

### Approbations

Certificate no. (cULus)	E258476	Institute (cULus)	CULUS
-------------------------	---------	-------------------	-------

**AMG ELM-Q2266**

**Weidmüller Interface GmbH & Co. KG**  
 Klingenbergstraße 26  
 D-32758 Detmold  
 Germany

www.weidmueller.com

**Technical data****Classifications**

ETIM 6.0	EC002057	ETIM 7.0	EC002057
ETIM 8.0	EC002057	ETIM 9.0	EC001437
ECLASS 9.0	27-37-10-16	ECLASS 9.1	27-37-10-16
ECLASS 10.0	27-37-10-16	ECLASS 11.0	27-37-10-16
ECLASS 12.0	27-37-10-16	ECLASS 13.0	27371016

**Environmental Product Compliance**

REACH SVHC	Lead 7439-92-1
SCIP	a7fff16c-85aa-4fb0-a206-7be03f41b0b7

**Approvals**

Approvals



ROHS	Conform
UL File Number Search	UL Website
Certificate no. (cULus)	E258476

**Downloads**

Approval/Certificate/Document of Conformity	<a href="#">Declaration of Conformity</a>
Engineering Data	<a href="#">CAD data – STEP</a>
Engineering Data	<a href="#">Zuken E3.S</a>
User Documentation	<a href="#">Manual maxGUARD</a> <a href="#">Operating instructions</a>
Catalogues	<a href="#">Catalogues in PDF-format</a>

**AMG ELM-Q2266**

**Weidmüller Interface GmbH & Co. KG**  
 Klingenbergstraße 26  
 D-32758 Detmold  
 Germany

www.weidmueller.com

**Drawings**

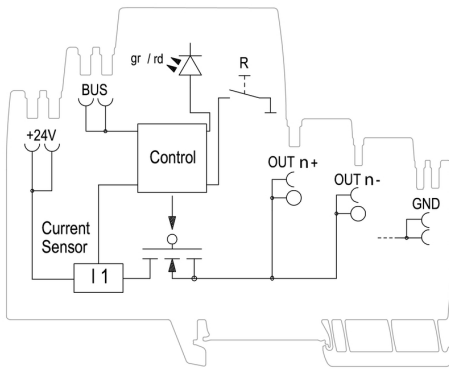

Schematic circuit diagram (per channel)

**Tripping characteristic normal**

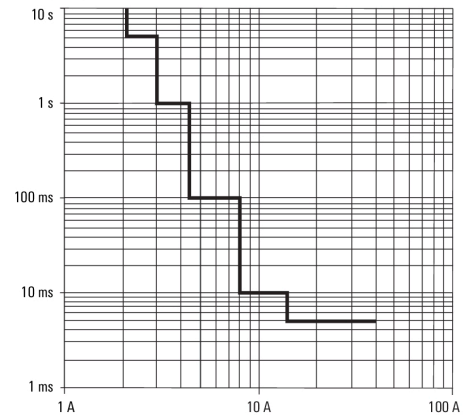

Tripping characteristic

**Tripping characteristic normal**

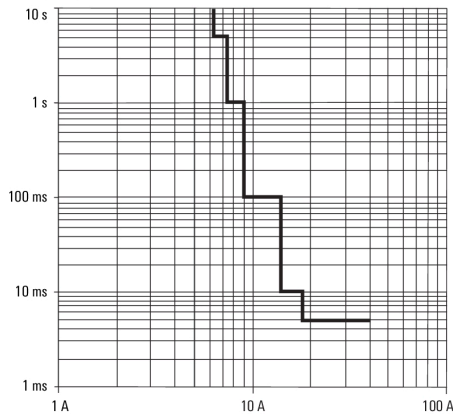

Tripping characteristic 6A

## AMG ELM-Q2266

**Weidmüller Interface GmbH & Co. KG**  
 Klingenbergstraße 26  
 D-32758 Detmold  
 Germany

www.weidmueller.com

## Accessories

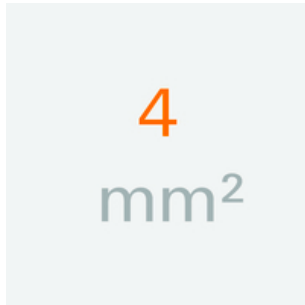
4 mm<sup>2</sup>

The plug-in cross-connections feature easy handling and quick installation. This saves a great deal of time during installation in comparison with screwed solutions.

## General ordering data

Type	ZQV 4N/8 BL
Order No.	<a href="#">1528190000</a>
GTIN (EAN)	4050118332858
Qty.	20 pc(s).
Type	ZQV 4N/6 BL
Order No.	<a href="#">1528170000</a>
GTIN (EAN)	4050118332926
Qty.	20 pc(s).
Type	ZQV 4N/6
Order No.	<a href="#">1527990000</a>
GTIN (EAN)	4050118332919
Qty.	20 pc(s).
Type	ZQV 4N/4 RD
Order No.	<a href="#">2460800000</a>
GTIN (EAN)	4050118476224
Qty.	60 pc(s).
Type	ZQV 4N/5 RD
Order No.	<a href="#">2460790000</a>
GTIN (EAN)	4050118476217
Qty.	60 pc(s).
Type	ZQV 4N/2 RD
Order No.	<a href="#">2460450000</a>
GTIN (EAN)	4050118476149
Qty.	60 pc(s).
Type	ZQV 4N/3
Order No.	<a href="#">1527940000</a>
GTIN (EAN)	4050118332865
Qty.	60 pc(s).
Type	ZQV 4N/7 RD
Order No.	<a href="#">2460770000</a>
GTIN (EAN)	4050118476194
Qty.	20 pc(s).
Type	ZQV 4N/2
Order No.	<a href="#">1527930000</a>
GTIN (EAN)	4050118332766
Qty.	60 pc(s).
Type	ZQV 4N/4 BL
Order No.	<a href="#">1528120000</a>
GTIN (EAN)	4050118332872
Qty.	60 pc(s).

Creation date December 5, 2023 8:26:41 AM CET

Catalogue status 24.11.2023 / We reserve the right to make technical changes.

## AMG ELM-Q2266

**Weidmüller Interface GmbH & Co. KG**

Klingenbergstraße 26

D-32758 Detmold

Germany

[www.weidmueller.com](http://www.weidmueller.com)

## Accessories

Type ZQV 4N/50  
 Order No. [1528130000](#)  
 GTIN (EAN) 4050118332902  
 Qty. 5 pc(s).

Type ZQV 4N/50 BL  
 Order No. [1528240000](#)  
 GTIN (EAN) 4050118333121  
 Qty. 5 pc(s).

Type ZQV 4N/6 RD  
 Order No. [2460780000](#)  
 GTIN (EAN) 4050118476200  
 Qty. 20 pc(s).

Type ZQV 4N/8 RD  
 Order No. [2460760000](#)  
 GTIN (EAN) 4050118476187  
 Qty. 20 pc(s).

Type ZQV 4N/9 BL  
 Order No. [1528220000](#)  
 GTIN (EAN) 4050118333107  
 Qty. 20 pc(s).

Type ZQV 4N/9  
 Order No. [1528070000](#)  
 GTIN (EAN) 4050118332797  
 Qty. 20 pc(s).

Type ZQV 4N/10 RD  
 Order No. [2460740000](#)  
 GTIN (EAN) 4050118476163  
 Qty. 20 pc(s).

Type ZQV 4N/5 BL  
 Order No. [1528140000](#)  
 GTIN (EAN) 4050118333015  
 Qty. 60 pc(s).

Type ZQV 4N/9 RD  
 Order No. [2460750000](#)  
 GTIN (EAN) 4050118476170  
 Qty. 20 pc(s).

Type ZQV 4N/10 BL  
 Order No. [1528230000](#)  
 GTIN (EAN) 4050118333138  
 Qty. 20 pc(s).

Type ZQV 4N/3 BL  
 Order No. [1528080000](#)  
 GTIN (EAN) 4050118333008  
 Qty. 60 pc(s).

Type ZQV 4N/5  
 Order No. [1527980000](#)  
 GTIN (EAN) 4050118332759  
 Qty. 60 pc(s).

Type ZQV 4N/3 RD  
 Order No. [2460810000](#)  
 GTIN (EAN) 4050118476231  
 Qty. 60 pc(s).

Creation date December 5, 2023 8:26:41 AM CET

Catalogue status 24.11.2023 / We reserve the right to make technical changes.

## AMG ELM-Q2266

**Weidmüller Interface GmbH & Co. KG**

Klingenbergstraße 26

D-32758 Detmold

Germany

[www.weidmueller.com](http://www.weidmueller.com)

## Accessories

Type	ZQV 4N/10
Order No.	<a href="#">1528090000</a>
GTIN (EAN)	4050118332896
Qty.	20 pc(s).

Type	ZQV 4N/7
Order No.	<a href="#">1528020000</a>
GTIN (EAN)	4050118332780
Qty.	20 pc(s).

Type	ZQV 4N/50 RD
Order No.	<a href="#">2460730000</a>
GTIN (EAN)	4050118476156
Qty.	5 pc(s).

Type	ZQV 4N/4
Order No.	<a href="#">1527970000</a>
GTIN (EAN)	4050118332889
Qty.	60 pc(s).

Type	ZQV 4N/7 BL
Order No.	<a href="#">1528180000</a>
GTIN (EAN)	4050118333114
Qty.	20 pc(s).

Type	ZQV 4N/2 BL
Order No.	<a href="#">1528040000</a>
GTIN (EAN)	4050118332773
Qty.	60 pc(s).

Type	ZQV 4N/8
Order No.	<a href="#">1528030000</a>
GTIN (EAN)	4050118332841
Qty.	20 pc(s).

## Standard version for machine construction

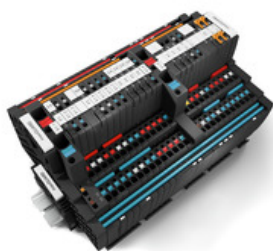

Efficient machine and facility operation calls for fail-safe and maintenance-friendly control voltage distribution that can be installed in a time and space-saving manner.

With the new maxGUARD system, the terminal blocks (previously installed separately) for distributing potential to the outputs of the electronic load monitors become an integral part of a 24 V DC control voltage distribution system.

The innovative combination of load monitoring and potential distribution saves time during installation, increases safety against failure and reduces the amount of space required on the terminal rail by 50%.

## General ordering data

Type	AMG PP	Version
Order No.	<a href="#">2123000000</a>	Partition plate
GTIN (EAN)	4050118425338	
Qty.	40 pc(s).	

Type	AMG XMD	Version
Order No.	<a href="#">2122940000</a>	Potential distributor
GTIN (EAN)	4050118425406	
Qty.	10 pc(s).	

Creation date December 5, 2023 8:26:41 AM CET

## AMG ELM-Q2266

**Weidmüller Interface GmbH & Co. KG**  
Klingenbergstraße 26  
D-32758 Detmold  
Germany

[www.weidmueller.com](http://www.weidmueller.com)

## Accessories

Type	AMG EP 2010	Version
Order No.	<a href="#">2495380000</a>	Fastening element
GTIN (EAN)	4050118505306	
Qty.	30 pc(s).	

### Slotted screwdriver

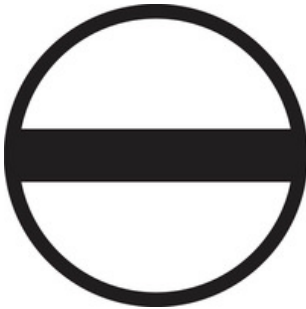

VDE insulated screwdriver sets, for working on live parts up to 1000 V AC and 1500 V DC, DIN EN 60900. IEC 900. Each piece is "GS" safety tested. Blade made from fully hardened, high-alloy chromium-vanadium-molybdenum steel, gun-metal finish.

### General ordering data

Type	SDIS SL 0.6X3.5X100	Version
Order No.	<a href="#">1274660000</a>	Screwdriver, Mounting tool
GTIN (EAN)	4050118072631	
Qty.	1 pc(s).	

### Blank



WS markers are the perfect match for the W-series connectors. Thanks to their system compatibility, the WS tags can also be used with the I-series and the Z-series. The large marking surfaces do not only permit long character strings but also multi-line text. WS markers are ideal for labels with long, customised character strings. Thanks to the proven MultiCard format, printing with PrintJet CONNECT oder/or Plotter is possible.

- Can be fitted in strips or individually
- Markers in proven MultiCard format

**For custom printing:** Please send us a file of our labeling software M-Print PRO or M-Print PRO Online (without installation) for your labeling specifications.

### General ordering data

Type	WS 10/6 M MC NE WS	Version
Order No.	<a href="#">1818400000</a>	WS, Terminal marker, 10 x 6 mm, Pitch in mm (P): 6.00 Weidmueller,
GTIN (EAN)	4032248310876	Allen-Bradley, white
Qty.	600 pc(s).	



**AMG ELM-Q2266**

**Weidmüller Interface GmbH & Co. KG**  
Klingenbergstraße 26  
D-32758 Detmold  
Germany

[www.weidmueller.com](http://www.weidmueller.com)

**Accessories****W-Series**

Weidmüller's range of products includes end brackets that guarantee a permanent, reliable mounting on the terminal rail and prevent sliding. Versions with and without screws are available. The end brackets include marking options, also for group markers, and also a test plug holder.

**General ordering data**

Type	WEW 35/2 V0 GF SW	Version
Order No.	<a href="#">1479000000</a>	W-Series, End bracket
GTIN (EAN)	4050118286779	
Qty.	50 pc(s).	