

LMZF 5/16/135 3.5OR

Weidmüller Interface GmbH & Co. KG

Klingenbergstraße 26

D-32758 Detmold

Germany

www.weidmueller.com

Product image

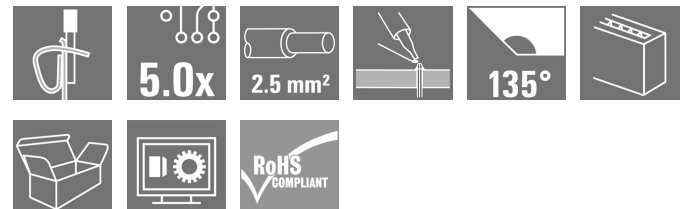
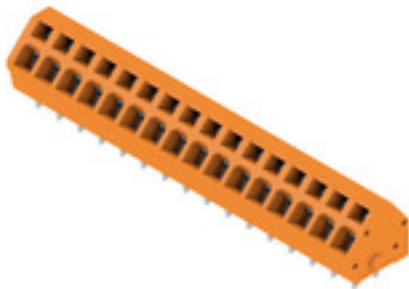

The compact installation terminal for the standard wire cross-section size of 2.5mm².

Tension clamp connection with a 135° outlet direction, in variable pitch: 5.00 - 5.08 mm (1 part with 2 pitches).

Rated data:

- 24A at 40°C / 630V (IEC) or 15A / 300V (UL)
- 0.13 - 2.5 mm² (IEC) / 26 - 14 AWG (UL)
- Flammability class according to UL 94: V0

Application benefits:

- Safe: ATEX certification Ex II 2GD / Ex e II (KEMA07 ATAEX0047U) optional
- Temperature resistant: long-term resistance up to 120°C provided by high-performance Wemid insulation material
- Adaptable: simple pitch adaptation from 5.00 to 5.08 mm (0.200 inch)
- Convenient: optional lever for simple opening of terminal point

General ordering data

Version	Printed circuit board terminals, 5.00 mm, Number of poles: 16, 135°, Solder pin length (l): 3.5 mm, tinned, orange, Tension-clamp connection, Clamping range, max.: 2.5 mm ² , Box
Order No.	1960170000
Type	LMZF 5/16/135 3.5OR
GTIN (EAN)	403224865065 1
Qty.	100 pc(s).
Product data	IEC: 630 V / 24 A / 0.13 - 2.5 mm ² UL: 300 V / 15 A / AWG 26 - AWG 14
Packaging	Box

LMZF 5/16/135 3.5OR

Weidmüller Interface GmbH & Co. KG

Klingenbergstraße 26

D-32758 Detmold

Germany

www.weidmueller.com

Technical data

Dimensions and weights

Depth	14.5 mm	Depth (inches)	0.571 inch
Height	16.4 mm	Height (inches)	0.646 inch
Height of lowest version	12.9 mm	Width	82.5 mm
Width (inches)	3.248 inch	Net weight	10 g

System parameters

Product family	OMNIMATE Signal - series LMZF	Wire connection method	Tension-clamp connection
Mounting onto the PCB	THT solder connection	Conductor outlet direction	135°
Pitch in mm (P)	5 mm	Pitch in inches (P)	0.197 "
Number of poles	16	Pin series quantity	1
Fitted by customer	No	Number of rows	1
Max. adjacent poles per row	48	Solder pin length (l)	3.5 mm
Solder pin dimensions	0.8 x 0.8 mm	Solder eyelet hole diameter (D)	1.3 mm
Solder eyelet hole diameter tolerance (D)+	0.1 mm	Number of solder pins per pole	2
Screwdriver blade	0.4 x 2.5	Screwdriver blade standard	DIN 5264-A
Stripping length	6 mm	L1 in mm	75 mm
L1 in inches	2.953 "	Touch-safe protection acc. to DIN VDE 0470	IP 20
Touch-safe protection acc. to DIN VDE 57 106	Safe from finger touch	Protection degree	IP20

Material data

Insulating material	Wemid (PA)	Colour	orange
Colour chart (similar)	RAL 2000	Insulating material group	I
Comparative Tracking Index (CTI)	≥ 600	UL 94 flammability rating	V-0
Contact material	Cu-alloy	Contact surface	tinned
Coating	5-8 µm SN	Tinning type	matt
Layer structure of solder connection	4...6 µm Sn matt	Storage temperature, min.	-40 °C
Storage temperature, max.	70 °C	Operating temperature, min.	-50 °C
Operating temperature, max.	120 °C	Temperature range, installation, min.	-25 °C
Temperature range, installation, max.	120 °C		

Conductors suitable for connection

Clamping range, min.	0.13 mm ²
Clamping range, max.	2.5 mm ²
Wire connection cross section AWG, min.	AWG 26
Wire connection cross section AWG, max.	AWG 14
Solid, min. H05(07) V-U	0.13 mm ²
Solid, max. H05(07) V-U	2.5 mm ²
Flexible, min. H05(07) V-K	0.13 mm ²
Flexible, max. H05(07) V-K	2.5 mm ²
w. plastic collar ferrule, DIN 46228 pt 4, min.	0.25 mm ²
w. plastic collar ferrule, DIN 46228 pt 4, max.	1.5 mm ²
w. wire end ferrule, DIN 46228 pt 1, min.	0.25 mm ²
w. wire end ferrule, DIN 46228 pt 1, max.	1.5 mm ²

Creation date March 12, 2024 11:49:13 AM CET

Catalogue status 09.03.2024 / We reserve the right to make technical changes.

2

LMZF 5/16/135 3.5OR

Weidmüller Interface GmbH & Co. KG
 Klingenbergstraße 26
 D-32758 Detmold
 Germany

www.weidmueller.com

Technical data

Clampable conductor	Cross-section for conductor connection	Type	fine-wired	
		nominal	0.5 mm ²	
	wire end ferrule	Stripping length	nominal	8 mm
		Recommended wire-end ferrule	H0.5/12 OR	
		Stripping length	nominal	6 mm
		Recommended wire-end ferrule	H0.5/6	
	Cross-section for conductor connection	Type	fine-wired	
		nominal	0.75 mm ²	
	wire end ferrule	Stripping length	nominal	8 mm
		Recommended wire-end ferrule	H0.75/12 W	
		Stripping length	nominal	6 mm
		Recommended wire-end ferrule	H0.75/6	
	Cross-section for conductor connection	Type	fine-wired	
		nominal	1 mm ²	
	wire end ferrule	Stripping length	nominal	8 mm
		Recommended wire-end ferrule	H1.0/12 GE	
		Stripping length	nominal	6 mm
		Recommended wire-end ferrule	H1.0/6	
	Cross-section for conductor connection	Type	fine-wired	
		nominal	0.25 mm ²	
wire end ferrule	Stripping length	nominal	8 mm	
	Recommended wire-end ferrule	H0.25/10 HBL		
	Stripping length	nominal	5 mm	
	Recommended wire-end ferrule	H0.25/5		
Cross-section for conductor connection	Type	fine-wired		
	nominal	0.34 mm ²		
wire end ferrule	Stripping length	nominal	8 mm	
	Recommended wire-end ferrule	H0.34/10 TK		

Reference text Length of ferrules is to be chosen depending on the product and the rated voltage., The outside diameter of the plastic collar should not be larger than the pitch (P)

Rated data acc. to IEC

tested acc. to standard	IEC 60664-1, IEC 61984	Rated current, min. number of poles (Tu=20°C)	24 A
Rated current, max. number of poles (Tu=20°C)	24 A	Rated current, min. number of poles (Tu=40°C)	24 A
Rated current, max. number of poles (Tu=40°C)	24 A	Rated voltage for surge voltage class / pollution degree II/2	630 V
Rated voltage for surge voltage class / pollution degree III/2	320 V	Rated voltage for surge voltage class / pollution degree III/3	250 V
Rated impulse voltage for surge voltage class/ pollution degree II/2	4 kV	Rated impulse voltage for surge voltage class/ pollution degree III/2	4 kV
Rated impulse voltage for surge voltage class/ contamination degree III/3	4 kV		

LMZF 5/16/135 3.5OR

Weidmüller Interface GmbH & Co. KG

Klingenbergstraße 26

D-32758 Detmold

Germany

www.weidmueller.com

Technical data

Rated data acc. to CSA

Institute (CSA)		Certificate No. (CSA)	200039-1815154
Rated voltage (Use group B / CSA)	300 V	Rated voltage (Use group D / CSA)	300 V
Rated current (Use group B / CSA)	10 A	Rated current (Use group D / CSA)	10 A
Wire cross-section, AWG, min.	AWG 26	Wire cross-section, AWG, max.	AWG 14
Reference to approval values	Specifications are maximum values, details - see approval certificate.		

Rated data acc. to UL 1059

Institute (cURus)		Certificate No. (cURus)	E60693
Rated voltage (Use group B / UL 1059)	300 V	Rated voltage (Use group D / UL 1059)	300 V
Rated current (Use group B / UL 1059)	15 A	Rated current (Use group D / UL 1059)	10 A
Wire cross-section, AWG, min.	AWG 26	Wire cross-section, AWG, max.	AWG 14
Reference to approval values	Specifications are maximum values, details - see approval certificate.		

Packing

Packaging	Box	VPE length	285 mm
VPE width	285 mm	VPE height	80 mm

Classifications

ETIM 6.0	EC002643	ETIM 7.0	EC002643
ETIM 8.0	EC002643	ETIM 9.0	EC002643
ECLASS 9.0	27-44-04-01	ECLASS 9.1	27-44-04-01
ECLASS 10.0	27-44-04-01	ECLASS 11.0	27-46-01-01
ECLASS 12.0	27-46-01-01	ECLASS 13.0	27-46-01-01

Important note

IPC conformity	Conformity: The products are developed, manufactured and delivered according international recognized standards and norms and comply with the assured properties in the data sheet resp. fulfill decorative properties in accordance with IPC-A-610 "Class 2". Further claims on the products can be evaluated on request.
Notes	<ul style="list-style-type: none"> Rated current related to rated cross-section & min. No. of poles. Wire end ferrule without plastic collar to DIN 46228/1 Wire end ferrule with plastic collar to DIN 46228/4 P on drawing = pitch Rated data refer only to the component itself. Clearance and creepage distances to other components are to be designed in accordance with the relevant application standards. Long term storage of the product with average temperature of 50 °C and maximum humidity 70%, 36 months

Creation date March 12, 2024 11:49:13 AM CET

Catalogue status 09.03.2024 / We reserve the right to make technical changes.

Data sheet

LMZF 5/16/135 3.5OR

Weidmüller Interface GmbH & Co. KG
 Klingenbergstraße 26
 D-32758 Detmold
 Germany

www.weidmueller.com

Technical data

Approvals

Approvals



ROHS	Conform
UL File Number Search	UL Website
Certificate No. (cURus)	E60693

Downloads

Approval/Certificate/Document of Conformity	Declaration of the Manufacturer
Engineering Data	CAD data – STEP
Catalogues	Catalogues in PDF-format
Brochures	FL DRIVES EN FL ANALO.SIGN.CONV. EN MB DEVICE MANUF. EN FL DRIVES DE FL BUILDING SAFETY EN FL APPL LED LIGHTING EN FL INDUSTR.CONTROLS EN FL MACHINE SAFETY EN FL HEATING ELECTR EN FL APPL INVERTER EN FL_BASE_STATION_EN FL ELEVATOR EN FL POWER SUPPLY EN FL 72H SAMPLE SER EN PO OMNIMATE EN PO OMNIMATE EN

LMZF 5/16/135 3.5OR

Weidmüller Interface GmbH & Co. KG
 Klingenbergstraße 26
 D-32758 Detmold
 Germany

www.weidmueller.com

Drawings

Product image

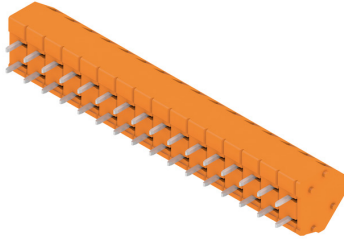

Dimensional drawing

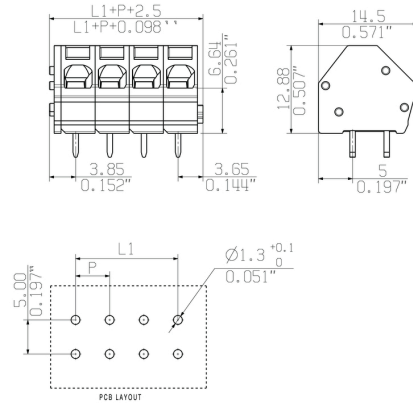

Graph

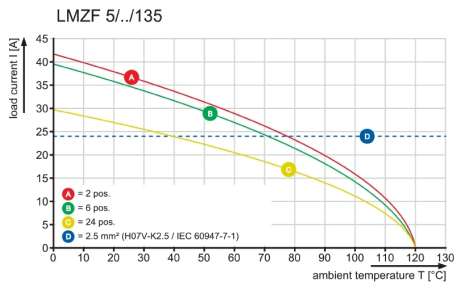

Recommended wave soldering profiles

Weidmüller Interface GmbH & Co. KG
 Klängenbergstraße 16
 D-32758 Detmold
 Germany
 Fon: +49 5231 14-0
 Fax: +49 5231 14-292083
 www.weidmueller.com

Single Wave:



Double Wave:



Wave soldering profiles

Wired connection elements should be processed in accordance with the DIN EN 61760-1 standard. We have included two recommendations for practical wave soldering profiles, with which Weidmüller PCB terminals and connectors are qualified.

When choosing a suitable profile for your application, the following factors also need to be considered:

- PCB thickness
- Proportion of Cu in the layers
- Single/double-sided assembly
- Product range
- Heating and cooling rates

The single and double wave profiles each indicate the recommended operating range, including the maximum soldering temperature of 260°C. In practice, the maximum soldering temperature is quite often well below the above maximum profile.