

## B2CF 3.50/16/180LR SN OR BX

**Weidmüller Interface GmbH & Co. KG**  
 Klingenbergstraße 26  
 D-32758 Detmold  
 Germany

www.weidmueller.com

### Product image

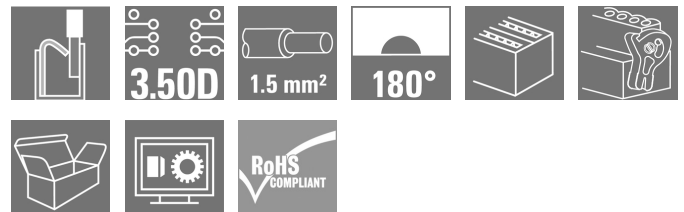
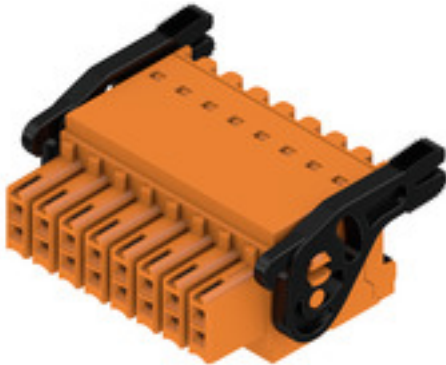

### Two-row female plug with PUSH IN spring connection

- Simply insert the prepared wire - and you're done
- Intuitive to use because
- the wire-entry area and handling area are clearly separated
- Integrated push-buttons for opening the terminal point
- High component density because of low heights
- Optional: locking and releasing require no tools when using Weidmüller's release latch (LR) or release lever (LH)

### General ordering data

Version	PCB plug-in connector, female plug, 3.50 mm, Number of poles: 16, 180°, PUSH IN with actuator, Clamping range, max. : 1.5 mm², Box
Order No.	<a href="#">1278 100000</a>
Type	B2CF 3.50/16/180LR SN OR BX
GTIN (EAN)	4050118068450
Qty.	48 pc(s).
Product data	IEC: 320 V / 13.4 A / 0.14 - 1.5 mm² UL: 300 V / 9.5 A / AWG 30 - AWG 16
Packaging	Box

Creation date March 12, 2024 3:12:17 PM CET

**B2CF 3.50/16/180LR SN OR BX****Weidmüller Interface GmbH & Co. KG**

Klingenbergstraße 26

D-32758 Detmold

Germany

www.weidmueller.com

**Technical data****Dimensions and weights**

Depth	29.9 mm	Depth (inches)	1.177 inch
Height	17.25 mm	Height (inches)	0.679 inch
Width	34.9 mm	Width (inches)	1.374 inch
Net weight	11.274 g		

**System Parameters**

Product family	OMNIMATE Signal - series B2C/S2C 3.50 - 2-row	Type of connection	Field connection
Wire connection method	PUSH IN with actuator	Pitch in mm (P)	3.5 mm
Pitch in inches (P)	0.138 "	Conductor outlet direction	180°
Number of poles	16	L1 in mm	24.5 mm
L1 in inches	0.965 "	Number of rows	1
Pin series quantity	2	Rated cross-section	15 mm <sup>2</sup>
Touch-safe protection acc. to DIN VDE 57 106	Safe from finger touch	Touch-safe protection acc. to DIN VDE 0470	IP20 plugged/ IP10 unplugged
Protection degree	IP20, when fully mounted	Can be coded	Yes
Stripping length	10 mm	Screwdriver blade	0.4 x 2.5
Screwdriver blade standard	DIN 5264	Plugging cycles	25
Plugging force/pole, max.	3.5 N	Pulling force/pole, max.	3.5 N

**Material data**

Insulating material	PA 66 GF 30	Colour	orange
Colour chart (similar)	RAL 2000	Insulating material group	II
Comparative Tracking Index (CTI)	≥ 600	Insulation strength	≥ 10 <sup>8</sup> Ω
UL 94 flammability rating	V-0	Contact material	Copper alloy
Contact surface	tinned	Layer structure of plug contact	2...5 μm Sn hot-dip tinned
Storage temperature, min.	-40 °C	Storage temperature, max.	70 °C
Operating temperature, min.	-50 °C	Operating temperature, max.	120 °C
Temperature range, installation, min.	-40 °C	Temperature range, installation, max.	120 °C

**Conductors suitable for connection**

Clamping range, min.	0.14 mm <sup>2</sup>
Clamping range, max.	1.5 mm <sup>2</sup>
Wire connection cross section AWG, min.	AWG 30
Wire connection cross section AWG, max.	AWG 16
Solid, min. H05(07) V-U	0.14 mm <sup>2</sup>
Solid, max. H05(07) V-U	1.5 mm <sup>2</sup>
Flexible, min. H05(07) V-K	0.14 mm <sup>2</sup>
Flexible, max. H05(07) V-K	1.5 mm <sup>2</sup>
w. plastic collar ferrule, DIN 46228 pt 4, 14 mm <sup>2</sup> min.	
w. plastic collar ferrule, DIN 46228 pt 4, 1 mm <sup>2</sup> max.	
w. wire end ferrule, DIN 46228 pt 1, 0.14 mm <sup>2</sup> min.	
w. wire end ferrule, DIN 46228 pt 1, 1.5 mm <sup>2</sup> max.	

Creation date March 12, 2024 3:12:17 PM CET

Catalogue status 09.03.2024 / We reserve the right to make technical changes.

**B2CF 3.50/16/180LR SN OR BX**

**Weidmüller Interface GmbH & Co. KG**  
 Klingenbergstraße 26  
 D-32758 Detmold  
 Germany

www.weidmueller.com

**Technical data**

Clampable conductor	Cross-section for conductor connection	nominal	0.14 mm <sup>2</sup>
	wire end ferrule	Stripping length	nominal 10 mm
		Recommended wire-end ferrule	<a href="#">H0.14/12 GR SV</a>
	Cross-section for conductor connection	nominal	0.25 mm <sup>2</sup>
	wire end ferrule	Stripping length	nominal 10 mm
		Recommended wire-end ferrule	<a href="#">H0.25/12 HBL SV</a>
	Cross-section for conductor connection	nominal	0.34 mm <sup>2</sup>
	wire end ferrule	Stripping length	nominal 10 mm
		Recommended wire-end ferrule	<a href="#">H0.34/12 TK SV</a>
	Cross-section for conductor connection	nominal	0.5 mm <sup>2</sup>
	wire end ferrule	Stripping length	nominal 12 mm
		Recommended wire-end ferrule	<a href="#">H0.5/16 OR SV</a>
		Stripping length	nominal 10 mm
		Recommended wire-end ferrule	<a href="#">H0.5/10</a>
	Cross-section for conductor connection	nominal	0.75 mm <sup>2</sup>
	wire end ferrule	Stripping length	nominal 12 mm
		Recommended wire-end ferrule	<a href="#">H0.75/16 W SV</a>
		Stripping length	nominal 10 mm
		Recommended wire-end ferrule	<a href="#">H0.75/10</a>
	Cross-section for conductor connection	nominal	1
	wire end ferrule	Stripping length	nominal 12 mm
		Recommended wire-end ferrule	<a href="#">H1.0/16 GE SV</a>
		Stripping length	nominal 10 mm
		Recommended wire-end ferrule	<a href="#">H1.0/10</a>
Cross-section for conductor connection	nominal	1.5 mm <sup>2</sup>	
wire end ferrule	Stripping length	nominal 10 mm	
	Recommended wire-end ferrule	<a href="#">H1.5/10</a>	

Reference text The outside diameter of the plastic collar should not be larger than the pitch (P). Length of ferrules is to be chosen depending on the product and the rated voltage.

**Rated data acc. to IEC**

tested acc. to standard	IEC 60664-1, IEC 61984	Rated current, min. number of poles (Tu=20°C)	13.4 A
Rated current, max. number of poles (Tu=20°C)	10 A	Rated current, min. number of poles (Tu=40°C)	12 A
Rated current, max. number of poles (Tu=40°C)	9 A	Rated voltage for surge voltage class / pollution degree II/2	320 V
Rated voltage for surge voltage class / pollution degree III/2	160 V	Rated voltage for surge voltage class / pollution degree III/3	160 V
Rated impulse voltage for surge voltage class/ pollution degree II/2	2.5 kV	Rated impulse voltage for surge voltage class/ pollution degree III/2	2.5 kV
Rated impulse voltage for surge voltage class/ contamination degree III/3	2.5 kV	Short-time withstand current resistance	3 x 1s with 80 A

## B2CF 3.50/16/180LR SN OR BX

**Weidmüller Interface GmbH & Co. KG**  
 Klingenbergstraße 26  
 D-32758 Detmold  
 Germany

www.weidmueller.com

## Technical data

### Rated data acc. to CSA

Institute (CSA)		Certificate No. (CSA)	
		200039-1121690	
Rated voltage (Use group B / CSA)	300 V	Rated voltage (Use group C / CSA)	50 V
Rated voltage (Use group D / CSA)	300 V	Rated current (Use group B / CSA)	9.5 A
Rated current (Use group C / CSA)	9.5 A	Rated current (Use group D / CSA)	9.5 A
Wire cross-section, AWG, min.	AWG 30	Wire cross-section, AWG, max.	AWG 16
Reference to approval values	Specifications are maximum values, details - see approval certificate.		

### Rated data acc. to UL 1059

Institute (cURus)		Certificate No. (cURus)	
		E60693	
Rated voltage (Use group B / UL 1059)	300 V	Rated voltage (Use group C / UL 1059)	50 V
Rated voltage (Use group D / UL 1059)	300 V	Rated current (Use group B / UL 1059)	9.5 A
Rated current (Use group C / UL 1059)	9.5 A	Rated current (Use group D / UL 1059)	9.5 A
Wire cross-section, AWG, min.	AWG 30	Wire cross-section, AWG, max.	AWG 16
Reference to approval values	Specifications are maximum values, details - see approval certificate.		

### Packing

Packaging	Box	VPE length	350 mm
VPE width	139 mm	VPE height	40 mm

### Type tests

Test: Durability of markings	Standard	IEC 61984 section 6.2 and 7.3.2 / 10.11 taking pattern from IEC 60068-2-70 / 12.95
	Test	mark of origin, type identification, pitch, type of material, date clock, approval marking UL, approval marking cULus
	Evaluation	available
	Test	durability
	Evaluation	passed
Test: Misengagement (Non-interchangeability)	Standard	IEC 61984 section 6.3 and 6.9.1 / 10.11, IEC 60512-13-5 / 02.06
	Test	180° turned without coding elements
	Evaluation	passed
	Test	180° turned with coding elements
	Evaluation	passed
	Test	visual examination
	Evaluation	passed

**B2CF 3.50/16/180LR SN OR BX**

**Weidmüller Interface GmbH & Co. KG**  
 Klingenbergstraße 26  
 D-32758 Detmold  
 Germany

www.weidmueller.com

**Technical data**

Test: Clampable cross section	Standard	IEC 60999-1 section 7 and 9.1 / 11.99, IEC 60947-1 section 8.2.4.5.1 / 03.11	
	Conductor type	Type of conductor and conductor cross-section	solid 0.14 mm <sup>2</sup>
		Type of conductor and conductor cross-section	stranded 0.14 mm <sup>2</sup>
		Type of conductor and conductor cross-section	solid 1.5 mm <sup>2</sup>
		Type of conductor and conductor cross-section	stranded 1.5 mm <sup>2</sup>
		Type of conductor and conductor cross-section	AWG 26/1
		Type of conductor and conductor cross-section	AWG 26/19
		Type of conductor and conductor cross-section	AWG 16/1
		Type of conductor and conductor cross-section	AWG 16/19
Evaluation	passed		
Test for damage to and accidental loosening of conductors	Standard	IEC 60999-1 section 9.4 / 11.99	
	Requirement	0.2 kg	
	Conductor type	Type of conductor and conductor cross-section	AWG 26/1
		Type of conductor and conductor cross-section	AWG 26/19
	Evaluation	passed	
	Requirement	0.3 kg	
	Conductor type	Type of conductor and conductor cross-section	H05V-U0.75
		Type of conductor and conductor cross-section	H05V-K0.75
	Evaluation	passed	
	Requirement	0.4 kg	
	Conductor type	Type of conductor and conductor cross-section	H07V-U1.5
		Type of conductor and conductor cross-section	H07V-K1.5
		Type of conductor and conductor cross-section	AWG 16/1
		Type of conductor and conductor cross-section	AWG 16/19
Evaluation	passed		

**B2CF 3.50/16/180LR SN OR BX**

**Weidmüller Interface GmbH & Co. KG**  
 Klingenbergstraße 26  
 D-32758 Detmold  
 Germany

www.weidmueller.com

**Technical data**

Pull-out test	Standard	IEC 60999-1 section 9.5 / 11.99		
	Requirement	≥10 N		
	Conductor type	Type of conductor and conductor cross-section	AWG 26/1	
		Type of conductor and conductor cross-section	AWG 26/19	
	Evaluation	passed		
	Requirement	≥20 N		
	Conductor type	Type of conductor and conductor cross-section	H05V-U0.75	
		Type of conductor and conductor cross-section	H05V-K0.75	
	Evaluation	passed		
	Requirement	≥40 N		
	Conductor type	Type of conductor and conductor cross-section	H07V-U1.5	
		Type of conductor and conductor cross-section	H07V-K1.5	
		Type of conductor and conductor cross-section	AWG 16/1	
		Type of conductor and conductor cross-section	AWG 16/19	
	Evaluation	passed		

**Classifications**

ETIM 6.0	EC002638	ETIM 7.0	EC002638
ETIM 8.0	EC002638	ETIM 9.0	EC002638
ECLASS 9.0	27-44-03-09	ECLASS 9.1	27-44-03-09
ECLASS 10.0	27-44-03-09	ECLASS 11.0	27-46-02-02
ECLASS 12.0	27-46-02-02	ECLASS 13.0	27-46-02-02

**B2CF 3.50/16/180LR SN OR BX**

**Weidmüller Interface GmbH & Co. KG**  
 Klingenbergstraße 26  
 D-32758 Detmold  
 Germany

[www.weidmueller.com](http://www.weidmueller.com)

**Technical data****Important note**

IPC conformity	Conformity: The products are developed, manufactured and delivered according international recognized standards and norms and comply with the assured properties in the data sheet resp. fulfill decorative properties in accordance with IPC-A-610 "Class 2". Further claims on the products can be evaluated on request.
Notes	<ul style="list-style-type: none"> <li>• Additional variants on request</li> <li>• Gold-plated contact surfaces on request</li> <li>• Rated current related to rated cross-section &amp; min. No. of poles.</li> <li>• Crimp shape A for wire-end ferrules with crimping tools PZ 1,5 (order no. 9005990000) or PZ 6/5 (order no. 9011460000) for larger wire cross-sections recommended.</li> <li>• P on drawing = pitch</li> <li>• Rated data refer only to the component itself. Clearance and creepage distances to other components are to be designed in accordance with the relevant application standards.</li> <li>• Max. outer diameter of the conductor 2.6 mm</li> <li>• In accordance with IEC 61984, OMNIMATE-connectors are connectors without breaking capacity (COC). During designated use, connectors are not allowed to be engaged or disengaged when live or under load</li> <li>• Long term storage of the product with average temperature of 50 °C and maximum humidity 70%, 36 months</li> </ul>

**Approvals**

Approvals



ROHS	Conform
UL File Number Search	UL Website
Certificate No. (cURus)	E60693

**B2CF 3.50/16/180LR SN OR BX****Weidmüller Interface GmbH & Co. KG**

Klingenbergstraße 26

D-32758 Detmold

Germany

www.weidmueller.com

**Technical data****Downloads**

Approval/Certificate/Document of Conformity	<a href="#">Declaration of the Manufacturer</a>
Engineering Data	<a href="#">CAD data – STEP</a>
Product Change Notification	<a href="#">PCN_2017_088_PL30X_BL_35_Lock_Release_lever_EN</a> <a href="#">PCN_2017_088_PL30X_PCN_BL_35_Loeseriegel_DE</a> <a href="#">Change of Material LR 3.50 - DE</a> <a href="#">Change of Material LR 3.50 - EN</a> <a href="#">20210721 Technical change Redesign B2CF 3.50</a> <a href="#">20210721 Technische Änderung Redesign zu B2CF 3.50</a> <a href="#">20220530 Change of packaging OMNIMATE® Signal B2CF 3.50</a> <a href="#">20220530 Verpackungsänderung OMNIMATE® Signal B2CF 3.50</a>
User Documentation	<a href="#">Operating instruction</a>
Catalogues	<a href="#">Catalogues in PDF-format</a>
Brochures	<a href="#">FL DRIVES EN</a> <a href="#">MB DEVICE MANUF. EN</a> <a href="#">FL DRIVES DE</a> <a href="#">FL BUILDING SAFETY EN</a> <a href="#">FL APPL LED LIGHTING EN</a> <a href="#">FLIndustr.CONTROLS EN</a> <a href="#">FL MACHINE SAFETY EN</a> <a href="#">FL HEATING ELECTR EN</a> <a href="#">FL APPL INVERTER EN</a> <a href="#">FL_BASE_STATION_EN</a> <a href="#">FL ELEVATOR EN</a> <a href="#">FL POWER SUPPLY EN</a> <a href="#">FL 72H SAMPLE SER EN</a> <a href="#">PO OMNIMATE EN</a> <a href="#">PO OMNIMATE EN</a>



**B2CF 3.50/16/180LR SN OR BX**

**Weidmüller Interface GmbH & Co. KG**  
 Klängenbergstraße 26  
 D-32758 Detmold  
 Germany

www.weidmueller.com

**Drawings**

**Product image**

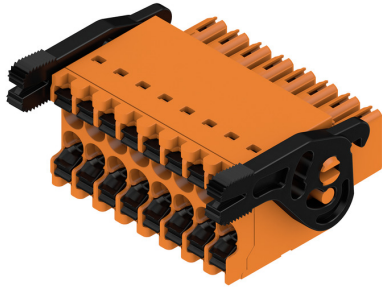

**Dimensional drawing**

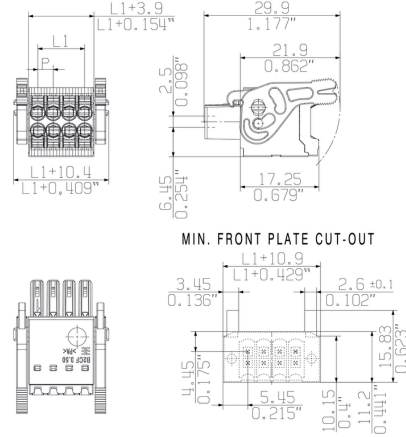

**Graph**

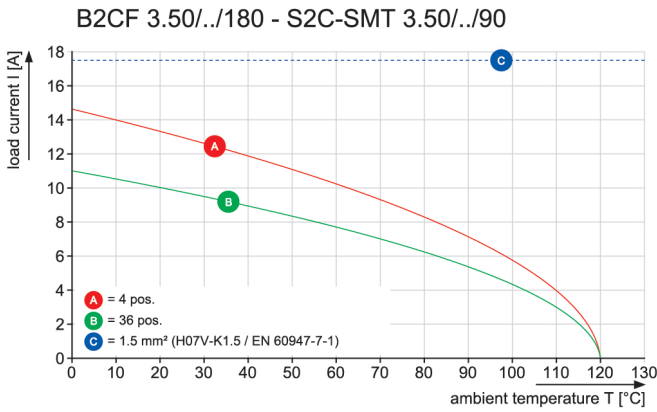

**Product benefits**

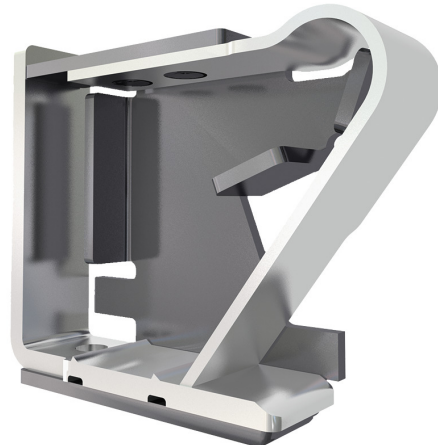

Solid PUSH IN contact  
 Safe and durable

**Product benefits**

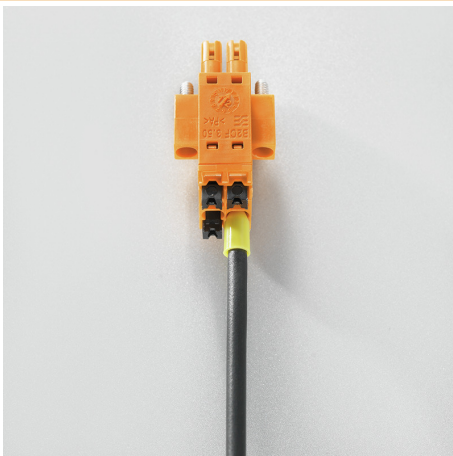

Large connection cross-section  
 Up to 1.5 mm possible with ease

**Product benefits**

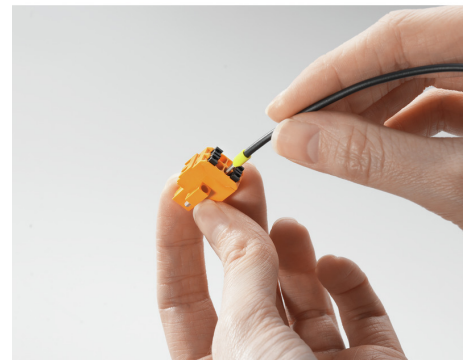

Fast PUSH IN connection  
 Tool-free and touch-safe

**B2CF 3.50/16/180LR SN OR BX**

**Weidmüller Interface GmbH & Co. KG**  
 Klingenbergstraße 26  
 D-32758 Detmold  
 Germany

www.weidmueller.com

**Accessories**

**Coding elements**



**Only connects what is supposed to be connected: the right connection at the right place.**

Coding elements and locking devices clearly assign connecting elements during the manufacturing process and operation

The coding elements and locking devices are inserted prior to assembly or during the cable assembly phase. The Weidmüller alternative: configure online using the variant configurator to precode prior to delivery.

Incorrect assembly on the circuit board and incorrect plugging of connecting elements is no longer possible. The advantage: no troubleshooting during manufacture and no operational errors by the user.

**General ordering data**

Type	B2L/S2L 3.50 KO BK BX	Version	Product data	Packaging
Order No.	<a href="#">1849740000</a>	PCB plug-in connector, Accessories, Coding element, black, Number		Box
GTIN (EAN)	4032248378203	of poles: 1		
Qty.	100 pc(s).			
Type	B2L/S2L 3.50 KO OR BX	Version	Product data	Packaging
Order No.	<a href="#">1849730000</a>	PCB plug-in connector, Accessories, Coding element, orange, Number		Box
GTIN (EAN)	4032248378197	of poles: 1		
Qty.	100 pc(s).			

**B2CF 3.50/16/180LR SN OR BX**

**Weidmüller Interface GmbH & Co. KG**  
Klingenbergstraße 26  
D-32758 Detmold  
Germany

[www.weidmueller.com](http://www.weidmueller.com)

**Drawings**

**Example of use**

