

ebm-papst Mulfingen GmbH & Co. KG  
 Bachmühle 2  
 D-74673 Mulfingen  
 Phone +49 (0) 7938 81-0  
 Fax +49 (0) 7938 81-110  
 info1@de.ebmpapst.com  
 www.ebmpapst.com

## CONTENTS

<b>1. SAFETY REGULATIONS AND NOTES</b>	<b>1</b>
1.1 Levels of hazard warnings	1
1.2 Staff qualification	1
1.3 Basic safety rules	1
1.4 Electrical voltage	1
1.5 Safety and protective functions	2
1.6 Electromagnetic radiation	2
1.7 Mechanical movement	2
1.8 Emission	2
1.9 Hot surface	2
1.10 Transport	2
1.11 Storage	2
1.12 Disposal	2
<b>2. PROPER USE</b>	<b>3</b>
<b>3. TECHNICAL DATA</b>	<b>4</b>
3.1 Product drawing	4
3.2 Nominal data	5
3.3 Technical features	5
3.4 Mounting data	5
3.5 Transport and storage conditions	5
3.6 Electromagnetic compatibility	5
<b>4. CONNECTION AND START-UP</b>	<b>6</b>
4.1 Connecting the mechanical system	6
4.2 Connecting the electrical system	6
4.3 Connection of the cables	6
4.4 Connection screen	7
4.5 Checking the connections	8
4.6 Switch on device	8
4.7 Switching off the device	8
<b>5. MAINTENANCE, MALFUNCTIONS, POSSIBLE CAUSES AND REMEDIES</b>	<b>8</b>
5.1 Cleaning	9
5.2 Safety test	9

## 1. SAFETY REGULATIONS AND NOTES

Please read these operating instructions carefully before starting to work with the device. Observe the following warnings to prevent malfunctions or physical damage to both property and people.

These operating instructions are to be regarded as part of this device. If the device is sold or transferred, the operating instructions must accompany it.

These operating instructions may be duplicated and forwarded for information about potential dangers and their prevention.

### 1.1 Levels of hazard warnings

These operating instructions use the following hazard levels to indicate potentially hazardous situations and important safety regulations:



#### **DANGER**

Indicates an imminently hazardous situation which, if not avoided, will result in death or serious injury. Compliance with the measures is mandatory.

#### **WARNING**

Indicates a potentially hazardous situation which, if not avoided, could result in death or serious injury. Exercise extreme caution while working.

#### **CAUTION**

Indicates a potentially hazardous situation which, if not avoided, may result in minor or moderate injury or damage of property.

#### **NOTE**

A potentially harmful situation can occur and, if not avoided, can lead to property damage.

### 1.2 Staff qualification

The device may only be transported, unpacked, installed, operated, maintained and otherwise used by qualified, trained and authorised technical staff.

Only authorised specialists are permitted to install the device, to carry out a test run and to perform work on the electrical installation.

### 1.3 Basic safety rules

Any safety hazards stemming from the device must be re-evaluated once it is installed in the end device.

Observe the following when working on the unit:

- ⇒ Do not make any modifications, additions or conversions to the device without the approval of ebm-papst.

### 1.4 Electrical voltage

- ⇒ Check the electrical equipment of the device at regular intervals, refer to chapter 5.2 Safety test.

- ⇒ Replace loose connections and defective cables immediately.

#### **WARNING**

**Terminals and connections have voltage even with a unit that is shut off**

Electric shock

→ Wait five minutes after disconnecting the voltage at all poles before opening the device.

#### **CAUTION**

**If control voltage is applied or a speed setpoint is stored, the motor automatically restarts, e.g. after a power failure.**  
 Danger of injury

- Keep out of the danger zone of the device.
- When working on the device, switch off the mains supply voltage and secure the latter from being switched on again.
- Wait until the device stops.
- After working on the device, remove any used tools or other objects from the device.

### 1.5 Safety and protective functions



#### DANGER

##### Missing safety device and non-functioning safety device

If there is no safety device, you could be seriously injured, for example if you reach into the running device or your hands are sucked into it.

- Operate the device only with a fixed and isolating safety protection and a fixed guard grille.  
The guard must withstand the kinetic energy of a fan blade detaching at maximum speed.
- The device is a built-in component. You, the owner/operator, are responsible for providing adequate protection for the device.
- Shut down the device immediately if you detect a missing or ineffective protective feature.

### 1.6 Electromagnetic radiation

Interference from electromagnetic radiation is possible, e.g. in conjunction with open and closed-loop control devices.

If unacceptable emission intensities occur when the fan is installed, appropriate shielding measures have to be taken by the user.

#### NOTE

**Electrical or electromagnetic interferences after integrating the device in installations on the customer's side.**

- Verify that the entire setup is EMC compliant.

### 1.7 Mechanical movement



#### DANGER

##### Rotating device

Body parts that come into contact with the rotor and impeller can be injured.

- Secure the device against accidental contact.
- Before working on the system/machine, wait until all parts have come to a standstill.

#### WARNING

##### Rotating device

Long hair, loose items of clothing and jewellery could become entangled and pulled into the device. You could be injured.

- Do not wear any loose clothing or jewellery while working on rotating parts.
- Protect long hair by wearing a cap.

### 1.8 Emission

#### WARNING

**Depending on the installation and operating conditions, a sound pressure level greater than 70 dB(A) may arise.**  
Danger of noise-induced hearing loss

- Take appropriate technical safety measures.
- Protect operating personnel with appropriate safety equipment, e.g. hearing protection.
- Also observe the requirements of local agencies.

### 1.9 Hot surface



#### CAUTION

##### High temperature at the electronics enclosure

Danger of burn injuries

- Ensure that sufficient protection against accidental contact is provided.

### 1.10 Transport

#### NOTE

##### Transport of device

- Transport the device in its original packaging only.
- Secure the device so that it does not slip, e.g. by using a clamping strap.

### 1.11 Storage

- ⇒ Store the device, partially or fully assembled, in a dry and weatherproof manner in the original packing in a clean environment.
- ⇒ Protect the device from environmental impacts and dirt until the final installation.
- ⇒ We recommend storing the device for a maximum up to one year to guarantee proper operation and longest possible service life.
- ⇒ Even devices explicitly suited for outdoor use are to be stored as described prior to being commissioned.
- ⇒ Maintain the storage temperature, see chapter 3.5 Transport and storage conditions.

### 1.12 Disposal

When disposing of the device, please comply with all relevant requirements and regulations applicable in your country.

## 2. PROPER USE

The device is exclusively designed as a built-in device for moving air according to its technical data.

Any other or secondary use is deemed improper and constitutes a misuse of the device.

Installations on the customer's side must meet the mechanical, thermal and service life-related stresses that can occur.

### Proper use also includes:

- Use the device in DC power systems only.
- Moving air with a density of 1.2 kg/m<sup>3</sup>.
- Using the device in accordance with the permitted ambient temperature, see chapter 3.5 Transport and storage conditions and chapter 3.2 Nominal data.
- Operating the device with all protective features in place.
- Minding the operating instructions.

### Improper use

Using the device in the following ways is particularly prohibited and may cause hazards:

- Operating the device with an imbalance, e.g. caused by dirt deposits or icing.
- Moving air that contains abrasive particles.
- Moving highly corrosive air, e.g. salt spray mist. Exceptions are devices that are intended for salt spray mist and protected accordingly.
- Moving air that contains dust pollution, e.g. suctioning off saw dust.
- Operating the device close to flammable materials or components.
- Operating the device in an explosive atmosphere.
- Using the device as a safety component or for taking on safety-related functions.
- Operation with completely or partially disassembled or modified protective features.
- In addition, all application options that are not listed under proper use.

## 3. TECHNICAL DATA

### 3.1 Product drawing

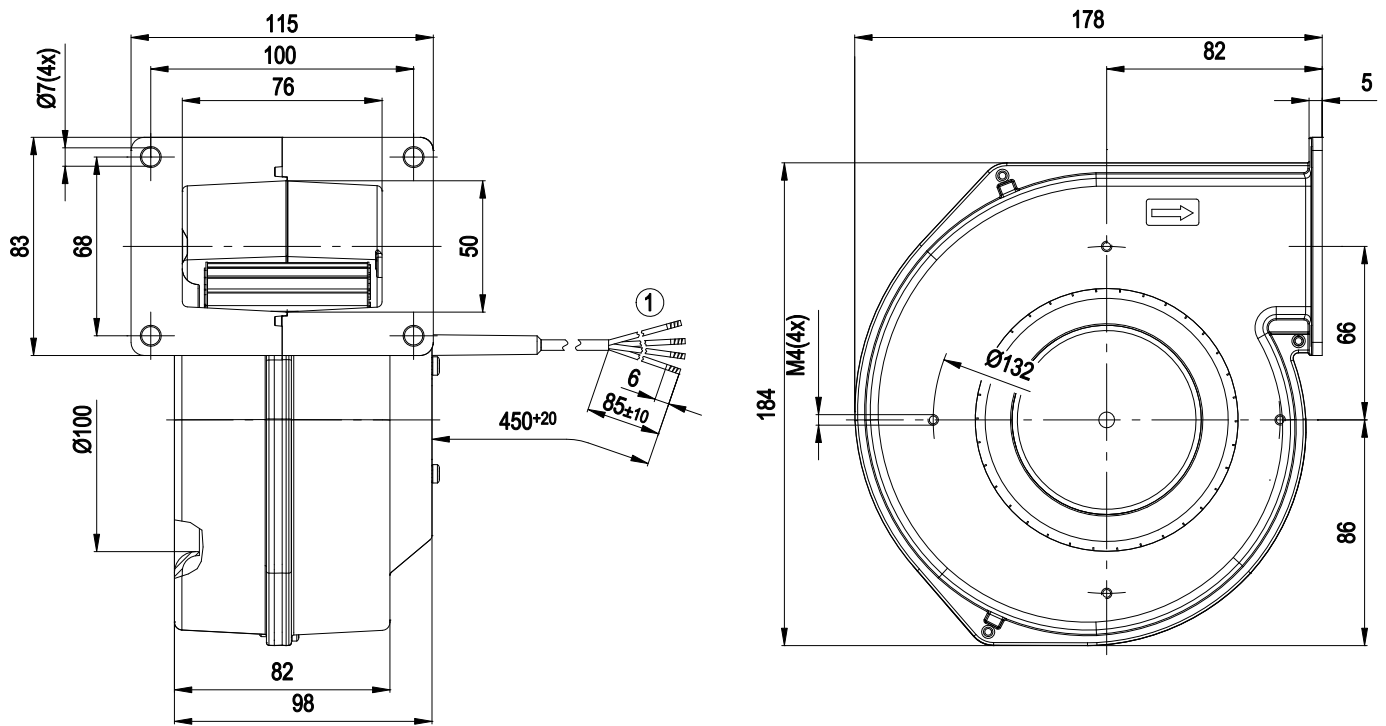

All measures have the unit mm.

1	Connection line AWG20, 4x brass lead tips crimped
---	---

### 3.2 Nominal data

<b>Motor</b>	M1G055-BD
<b>Nominal voltage / VDC</b>	24
<b>Nominal voltage range / VDC</b>	16 .. 28
<b>Type of data definition</b>	fa
<b>Speed / min<sup>-1</sup></b>	2200
<b>Power input / W</b>	40
<b>Current draw / A</b>	1.9
<b>Min. ambient temperature / °C</b>	-25
<b>Max. ambient temperature / °C</b>	60

ml = Max. load · me = Max. efficiency · fa = Running at free air  
 cs = Customer specs · cu = Customer unit

Subject to alterations

### 3.3 Technical features

<b>Mass</b>	1.57 kg
<b>Size</b>	120 mm
<b>Surface of rotor</b>	Thick layer passivated
<b>Material of impeller</b>	Sheet steel, hot-galvanised
<b>Housing material</b>	Die-cast aluminium
<b>Direction of rotation</b>	Clockwise, seen on rotor
<b>Type of protection</b>	IP 22
<b>Insulation class</b>	"B"
<b>Humidity class</b>	F0
<b>Mounting position</b>	Any
<b>Condensate discharge holes</b>	None
<b>Operation mode</b>	S1
<b>Motor bearing</b>	Ball bearing
<b>Technical features</b>	- Control input 0-10 VDC / PWM - Tach output - Motor current limit - Soft start
<b>Motor protection</b>	Reverse polarity and locked-rotor protection
<b>Cable exit</b>	Axial
<b>Product conforming to standard</b>	EN 60950-1
<b>Approval</b>	CSA C22.2 Nr.77; EAC; UL 1004-1



For cyclic speed loads, note that the rotating parts of the device are designed for maximum one million load cycles. If you have specific questions, contact ebm-papst for support.

### 3.4 Mounting data

For depth of screw, see chapter 3.1 Product drawing

⇒ Secure the mounting screws against accidentally coming loose (e.g. by using self-locking screws).

<b>Strength class for mounting screws</b>	8.8
---	-----

You can obtain additional mounting data from the product drawing if necessary.

### 3.5 Transport and storage conditions

⇒ Use the device in accordance with its protection type.

<b>Max. permissible ambient motor temp. (transp./ storage)</b>	+ 80 °C
<b>Min. permissible ambient motor temp. (transp./storage)</b>	- 40 °C

### 3.6 Electromagnetic compatibility

<b>EMC interference immunity</b>	Acc. to EN 61000-6-2 (industrial environment)
<b>EMC interference emission</b>	Acc. to EN 61000-6-3 (household environment)

## 4. CONNECTION AND START-UP

### 4.1 Connecting the mechanical system



#### CAUTION

**Cutting and crushing hazard when removing the blower from the packaging**



→ Carefully remove the blower from its packaging, only touching the housing. Make sure to avoid any shock.

→ Wear safety shoes and cut-resistant safety gloves.

⇒ Check the device for transport damage. Damaged devices must no longer be installed.

⇒ Install the undamaged device according to your application.

### 4.2 Connecting the electrical system

#### CAUTION

##### Electrical voltage

The device is a built-in component and features no electrically isolating switch.

→ Connect the device only to circuits that can be switched off using an all-pole disconnecting switch.

→ When working on the device, you must switch off the system/machine in which the device is installed and secure it from being switched on again.

#### NOTE

##### Water penetration into leads or wires

Water enters at the cable end on the customers side and can damage the device.

→ Make sure that the cable end is connected in a dry environment.



Operate the device with a safely isolated power pack.

#### 4.2.1 Prerequisites

- ⇒ Check whether the data on the type plate agree with the connection data.
- ⇒ Before connecting the device, ensure that the supply voltage matches the operating voltage of the device.
- ⇒ Only use cables designed for current according to the type plate. For determining the cross-section, follow the basic principles in accordance with EN 61800-5-1. The protective earth must have a cross-section equal to or greater than the outer conductor cross-section. We recommend the use of 105°C cables. Ensure that the minimum cable cross-section is at least AWG26/0.13 mm<sup>2</sup>.

#### 4.2.2 Idle current



Because of the EMC filter integrated for compliance with EMC limits (interference emission and interference immunity), idle currents in the mains cable can be measured even when the motor is at a standstill and the mains voltage is switched on.

### 4.3 Connection of the cables

External leads are brought out of device.

- Connect the lines according to your application. When doing so, observe chapter 4.4 Connection screen.

## 4.4 Connection screen

### Customer circuit

#### Full speed

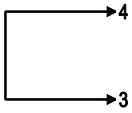

#### Speed setting

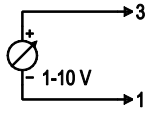

10 V → n = max  
 1 V → n = min  
 <1 V → n = 0  
 Safe start-up at U<sub>nom</sub> -30 %  
 from 4 V U<sub>contr.</sub>

#### Speed setting with fixed resistance

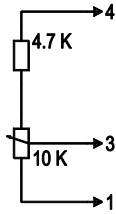

#### Speed setting via PWM 1-10 kHz

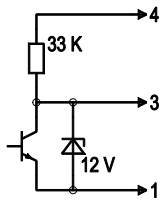

100 % PWM → n = max  
 10 % PWM → n = min  
 <10 % PWM → n = 0  
 Safe start-up at U<sub>nom</sub> -30 %  
 from 40 % PWM

#### Setting of values via temperature controller

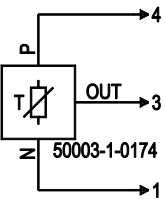

### Connection

### Fan / motor

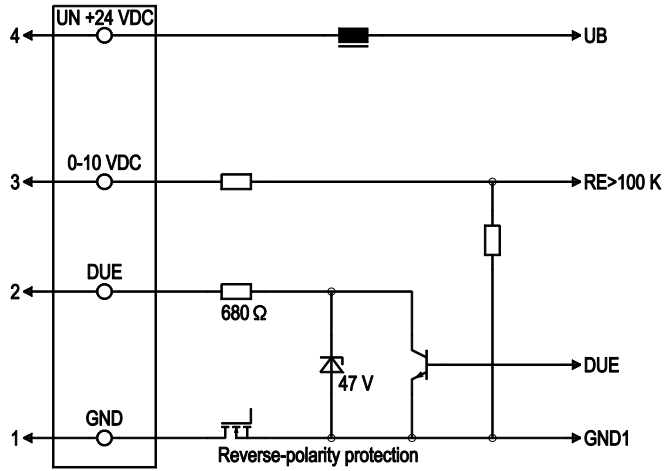

No.	Conn.	Designation	Colour	Function / assignment
1	1	GND	blue	Reference mass
1	2	Tach	white	Speed monitoring output, 2 pulses per rotation, I <sub>sink</sub> max = 10 mA
1	3	0-10 VDC	yellow	Control input Re > 100 K
1	4	Un +24 VDC	red	Power supply 24 VDC, residual ripple 3.5 %

#### 4.5 Checking the connections

- ⇒ Make sure that the power is off (all phases).
- ⇒ Secure it from being switched on again.
- ⇒ Check the correct fit of the connection lines.

#### 4.6 Switch on device

The device may only be switched on if it has been installed properly and in accordance with its intended use, including the required safety mechanisms and professional electrical connection. This also applies for devices which have already been equipped with plugs and terminals or similar connectors by the customer.



**WARNING**  
**Hot motor housing**  
 Fire hazard

- Ensure that no combustible or flammable materials are located close to the blower.
- ⇒ Inspect the device for visible external damage and the proper function of the protective features before switching it on.
- ⇒ Check the air flow paths of the fan for foreign objects and remove any that are found.
- ⇒ Apply the nominal voltage to the voltage supply.
- ⇒ Start the device by changing the input signal.

#### 4.7 Switching off the device

Switching off the device during operation:

- ⇒ Switch off the device via the control input.
- ⇒ Do not switch the motor (e.g. in cyclic operation) on and off via power supply.

Switching off the device for maintenance work:

- ⇒ Switch off the device via the control input.
- ⇒ Do not switch the motor (e.g. in cyclic operation) on and off via power supply.
- ⇒ Disconnect the device from the supply voltage.

## 5. MAINTENANCE, MALFUNCTIONS, POSSIBLE CAUSES AND REMEDIES

Do not perform any repairs on your device. Return the device to ebm-papst for repair or replacement.

### WARNING

**Terminals and connections have voltage even with a unit that is shut off**

Electric shock

- Wait five minutes after disconnecting the voltage at all poles before opening the device.

### CAUTION

**If control voltage is applied or a speed setpoint is stored, the motor automatically restarts, e.g. after a power failure.**

Danger of injury

- Keep out of the danger zone of the device.
- When working on the device, switch off the mains supply voltage and secure the latter from being switched on again.
- Wait until the device stops.
- After working on the device, remove any used tools or other objects from the device.



If the device remains out of use for some time, e.g. when in storage, we recommend switching the device on for at least two hours to allow any condensate to evaporate and to move the bearings.

Malfunction/error	Possible cause	Possible remedy
<b>Impeller running roughly</b>	Imbalance in rotating parts	Clean the device; if imbalance is still evident after cleaning, replace the device. If you have attached any weight clips during cleaning, make sure to remove them afterwards.
<b>Motor does not turn</b>	Mechanical blockage	Switch off, de-energise, and remove mechanical blockage.
	Mains supply voltage faulty	Check mains supply voltage, restore power supply, apply control signal.
	Faulty connection	De-energise, correct connection, see connection diagram.



<b>Overtemperature of electronics/motor</b>	Insufficient cooling	Improve cooling. Let the device cool down. To reset the error message, switch off the mains supply voltage for a min. of 25 s and switch it on again.
	Ambient temperature too high	Reduce the ambient temperature. Reset by reducing control input to 0.
	Unacceptable operating point	Correct the operating point. Let the device cool down.



If you have any other problems, contact ebm-papst.

## 5.1 Cleaning

### NOTE

#### Damage to the device during cleaning.

Malfunction possible

- Do not clean the device using a water jet or high-pressure washer.
- Do not use any cleaners containing acids, bases or solvents.
- Do not use any pointed or sharp-edged objects to clean.

## 5.2 Safety test

What has to be tested?	How to test?	Frequency	Which measure?
Check the protective casing against accidental contact for damage and to ensure that it is intact	Visual inspection	At least every 6 months	Repair or replacement of the device
Check the device for damage to blades and housing	Visual inspection	At least every 6 months	Replacement of the device
Mounting the connection lines	Visual inspection	At least every 6 months	Fasten
Check the insulation of the wires for damage	Visual inspection	At least every 6 months	Replace wires

