

Rotary DIP Switch

A6R/A6RV

Through-hole mounting Rotary DIP Switches

- Top/Side-actuated, and Flat/Extended-actuator models available.
- Actuator with an O-ring sealed structure prevents the ingress of dirt and dust.
- Two different terminal arrangements allow the flexibility of circuit design.

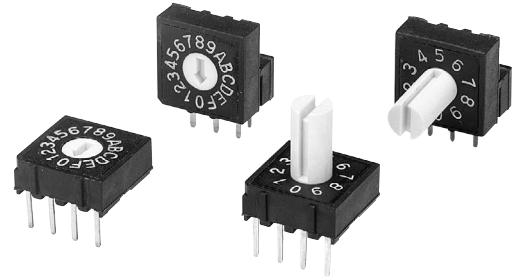

RoHS Compliant

List of Models

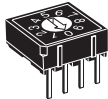
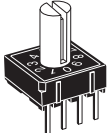
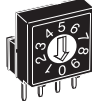
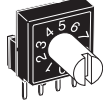
Type (actuator color)				Top-actuated, flat (white)	Top-actuated, extended actuator (white)	Side-actuated, flat (white)	Side-actuated, extended actuator (white)
Number of positions	Quantity per tube	Terminal arrangement	Output code				
10	48	4 × 1	BCD Decimal	A6R-101RF	A6R-101RS	A6RV-101RF	A6RV-101RS
		3 × 3		A6R-102RF	A6R-102RS	A6RV-102RF	A6RV-102RS
16	48	4 × 1	BCD Hexadecimal	A6R-161RF	A6R-161RS	A6RV-161RF	A6RV-161RS
		3 × 3		A6R-162RF	A6R-162RS	A6RV-162RF	A6RV-162RS

Note: Order in multiples of the package quantity.

Ratings/Characteristics

Ratings	25 mA at 24 VDC, 10 μA (minimum current) at 3.5 VDC	
Ambient operating temperature	-25 to +80°C 60%RH max. (with no icing or condensation)	
Ambient operating humidity	35% to 95% (at +5 to +35°C)	
Insulation resistance	100 MΩ min. (at 250 VDC)	
Contact resistance	200 mΩ max. (initial value)	
Dielectric strength	Between terminals	250 VAC for 1 min
Vibration resistance	Malfunction	10 to 55 Hz, 1.5-mm double amplitude
Shock resistance	Malfunction	300 m/s ² min.
Durability	Electrical	5,000 steps min.
Operating torque	1.96 × 10 ⁻² N·m {2 gf·m} max.	
Weight	Top-actuated: Approx. 0.6 g Side-actuated: Approx. 0.8 g (Add 0.13 g for the extended-actuator type of each model.)	

Output Codes

10-position Models

Code	BCD Decimal code			
	Position 1	2	4	8
0				
1	●			
2		●		
3	●	●		
4			●	
5	●		●	
6		●	●	
7	●	●	●	
8				●
9	●			●

16-position Models

Code	BCD Hexadecimal code			
	Position 1	2	4	8
0				
1	●			
2		●		
3	●	●		
4			●	
5	●		●	
6		●	●	
7	●	●	●	
8				●
9	●			●
A		●		●
B	●	●		●
C			●	●
D	●		●	●
E		●	●	●
F	●	●	●	●

Note: "●" indicates that the internal switch is ON.

■ Dimensions (Unit: mm)

● **Top-actuated Flat Models with 4×1 Terminal Arrangement**

A6R-101RF
A6R-161RF

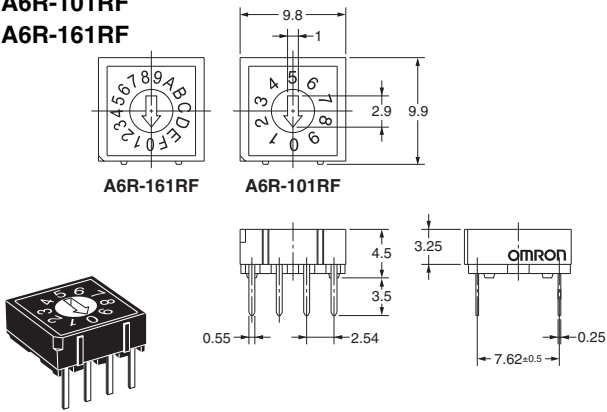

● **Top-actuated Extended-actuator Models with 4×1 Terminal Arrangement**

A6R-101RS
A6R-161RS

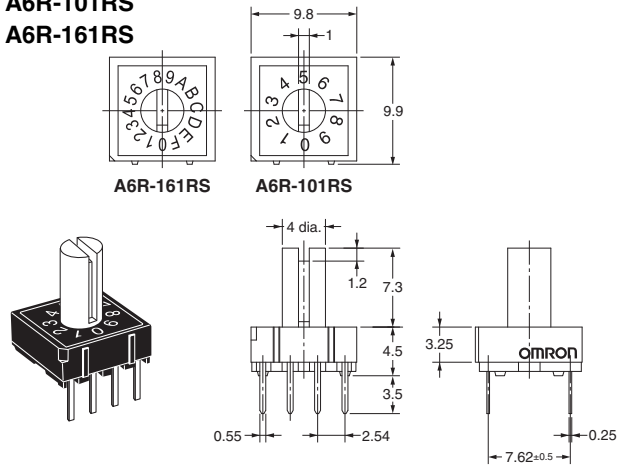

● **Top-actuated Flat Models with 3×3 Terminal Arrangement**

A6R-102RF
A6R-162RF

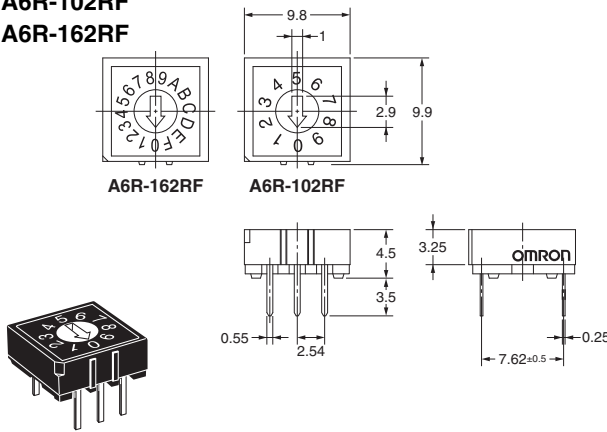

● **Top-actuated Extended-actuator Models with 3×3 Terminal Arrangement**

A6R-102RS
A6R-162RS

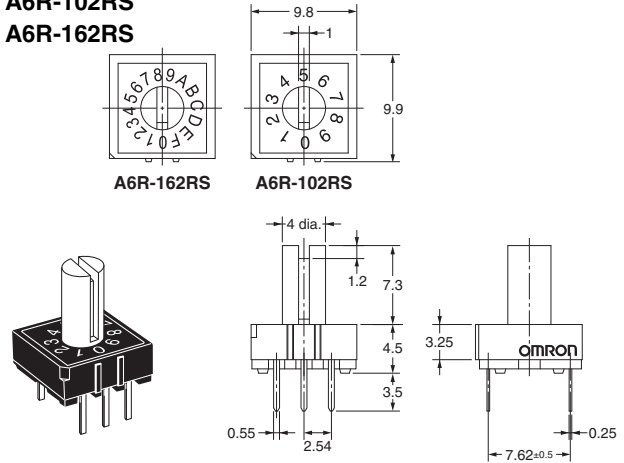

● **Side-actuated Flat Models with 4×1 Terminal Arrangement**

A6RV-101RF
A6RV-161RF

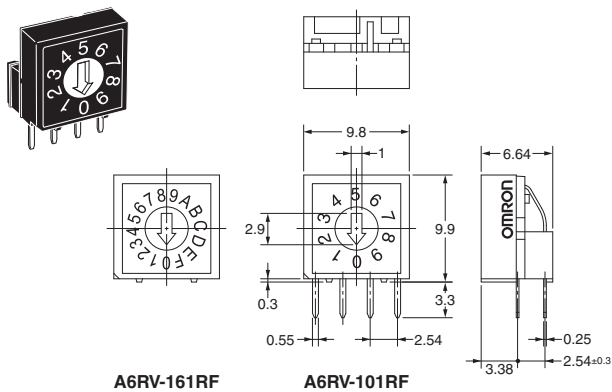

● **Side-actuated Extended-actuator Models with 4×1 Terminal Arrangement**

A6RV-101RS
A6RV-161RS

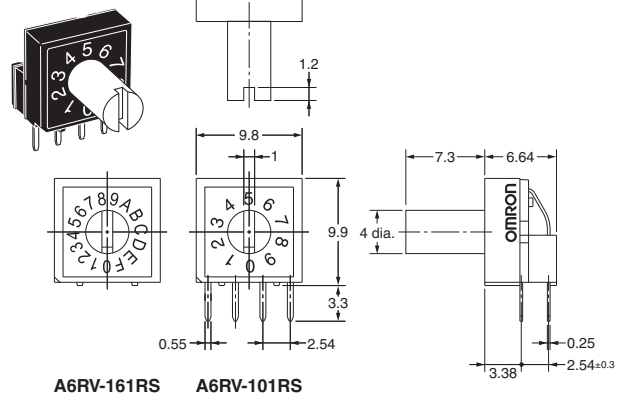

Note: Unless otherwise specified, a tolerance of ±0.4 mm applies to all dimensions.

● Side-actuated Flat Models with 3×3 Terminal Arrangement

A6RV-102RF
A6RV-162RF

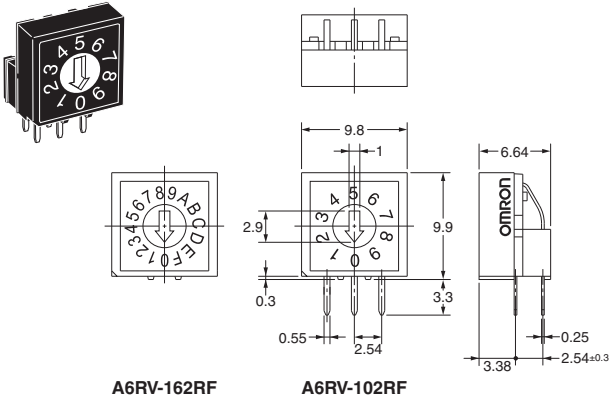

● Side-actuated Extended-actuator Models with 3×3 Terminal Arrangement

A6RV-102RS
A6RV-162RS

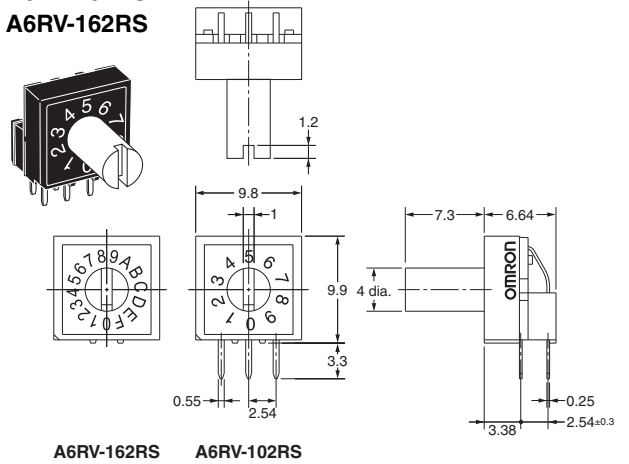

■ PCB Dimensions

● Top-actuated Models
4×1 Terminal Arrangement

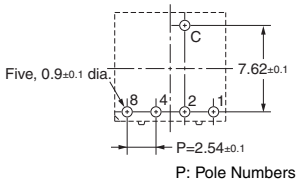

3×3 Terminal Arrangement

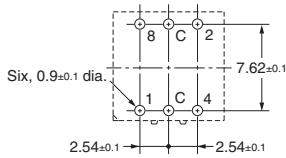

● Side-actuated Models
4×1 Terminal Arrangement

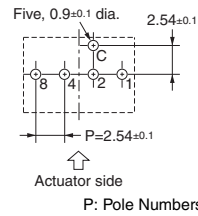

3×3 Terminal Arrangement

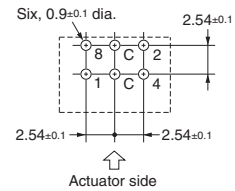

Note: Unless otherwise specified, a tolerance of ±0.4 mm applies to all dimensions.

■ Internal Connections

Contact Form (Top View)

● Top-actuated Models
4×1 Terminal Arrangement

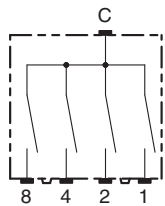

3×3 Terminal Arrangement

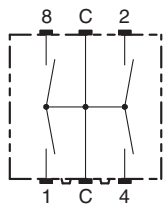

● Side-actuated Models
4×1 Terminal Arrangement

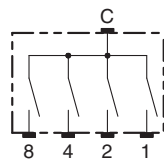

3×3 Terminal Arrangement

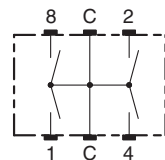

■ Precautions

Be sure to read the Safety precautions common to all DIP Switches for correct use.

- Application examples provided in this document are for reference only. In actual applications, confirm equipment functions and safety before using the product.
- Consult your OMRON representative before using the product under conditions which are not described in the manual or applying the product to nuclear control systems, railroad systems, aviation systems, vehicles, combustion systems, medical equipment, amusement machines, safety equipment, and other systems or equipment that may have a serious influence on lives and property if used improperly. Make sure that the ratings and performance characteristics of the product provide a margin of safety for the system or equipment, and be sure to provide the system or equipment with double safety mechanisms.

Note: Do not use this document to operate the Unit.

OMRON Corporation

ELECTRONIC AND MECHANICAL COMPONENTS COMPANY

Contact: www.omron.com/ecb

**Cat. No. A212-E1-01
0812(0207)(O)**