

SERIES 53, 57 and 59
1.125" Diameter, 1/4 Amp

FEATURES

- Smallest Diameter Rotary Switch with this Number of Positions and Current Capacity
- Military Qualified MIL-DTL-3786/36
- Gold-plated Contact System Compatible with Logic Circuitry



DIMENSIONS in inches (and millimeters)

Military Style



No. of Decks	Dimension A	Dimension B	Approx. Weight Grams	No. of Decks	Dimension A	Dimension B	Approx. Weight Grams
1	.916 (23,27)	.032 (0,81)	50	7	3.164 (80,37)	.281 (7,14)	110
2	1.249 (31,72)	.032 (0,81)	60	8	3.497 (88,82)	.281 (7,14)	120
3	1.582 (40,18)	.032 (0,81)	70	9	3.830 (97,28)	.281 (7,14)	130
4	1.915 (48,64)	.032 (0,81)	80	10	4.163 (105,74)	.281 (7,14)	140
5	2.248 (57,10)	.032 (0,81)	90	11	4.496 (114,20)	.281 (7,14)	150
6	2.831 (71,91)	.281 (7,14)	100	12	4.829 (122,66)	.281 (7,14)	160

Mounting Hardware: Two mounting nuts, .094" (2,39) thick by .562" (14,27) across flats, one internal tooth lockwasher and one non-turn washer (see detail D for dimensions), are supplied with switch.

Grayhill part number and date code marked on detent cover label. Customer part number marked on request. Military part number marked when required.

Non-Turn Washer Detail D

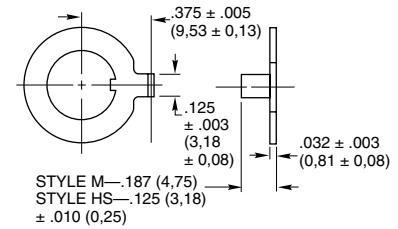

STANDARD STYLE MILITARY QUALIFIED

The Series 53, 57 and 59 rotary switches are all military type switches. Grayhill manufactures these switches in two styles: M and HS. Style M is unsealed and is *not* qualified; Style HS is shaft and panel sealed and *is* qualified. The non-qualified Style M can be regarded as our Standard Style for types of switches. Although it is not qualified, Style M is constructed of the same military grade materials and will provide comparable performance in all areas. For example, the Style 'M' switches, in addition to the electrical ratings listed elsewhere in these pages, will meet the following requirements of MIL-DTL-3786:

Moisture Resistance: Medium and High Shock; Vibration (10 to 500 cps); Thermal Shock (-65 °C to 125 °C); Salt Spray; Explosion; Terminal Strength (pull, 2 lbs. minimum); and Stop Strength (15 pound-inches minimum).

The line drawings shown above are applicable to the Style M and Style HS. The only difference between the two is the length of the tab of the non-turn washer. The shorter tab for the HS is explained in the following paragraph.

The Series 53, 57 and 59 Style HS rotary switches are qualified to MIL-DTL-3786/36. The Style HS is shaft and panel sealed. The panel is sealed by an O-ring at the base of the bushing. The shaft is sealed by an O-ring inside the bushing. These seals do not alter the dimensions shown in the line drawings when the switch is mounted.

A non-turn washer, supplied with the mounting hardware, may be used with the Style HS switches. It is suggested that the non-turn washer be mounted in the following manner to preserve the seal: from the front of the panel into a hole that does not go through the panel.

The qualification of the Series 53, 57 and

59 rotary switches does not extend to all possible combinations listed in the Choices and Limitations chart. The limitations on the qualification are described in the chart shown below.

Standard variations, such as shaft and/or bushing length, etc., that do not affect switch performance can also be marked as qualified product. For complete details contact Grayhill. Military qualified Series 53, 57 and 59 Style HS rotary switches may be ordered by the 'M' number listed in MIL-DTL-3786/36 or by the Grayhill part number. Military style switches will be marked to the specification.

Style HS Switches are MIL-DTL-3786/36 Qualified for the Following Characteristics

Series	Max. No. of Decks	Max. No. Poles/Deck	Max. No. Total Poles/Switch
53	5	8	24
57	5	4	20
59	5	5	20

SPECIFICATIONS

Electrical Ratings

General

Switch rating for break before make contacts.

Voltage: As listed in the chart.

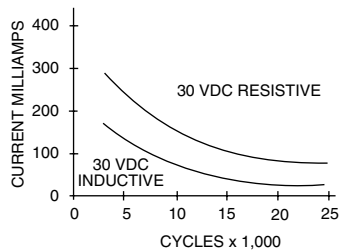
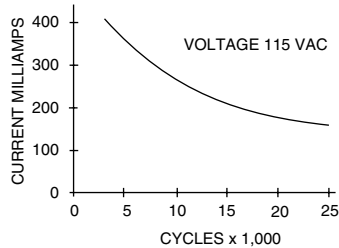

Curve data based on test data conducted at sea level, 25°C and relative humidity. Cycle equals 360° rotation and 360° return. Cycling rate is 10 cycles per minute. The curves shown are typical load life curves for a Series 53M, 57M and 59M Rotary Switch. They show the number of cycles of rotational life that can be expected for the voltages, currents and types of loads shown. Thus, with a 250 milliamperes, 30 Vdc resistive load, 10,000 cycles of life can be expected. Life limiting or failure criteria for these curves are:

Contact Resistance: 50 milliohms maximum (20 milliohms initially).

Insulation Resistance: 1,000 megohms minimum between mutually insulated parts.

Voltage Breakdown: 500Vac minimum between mutually insulated parts. These switches will carry 4 amperes with a maximum contact temperature rise of 20°C. If the life limiting characteristics are less critical than those shown above or if elevated temperatures or reduced pressures are involved, Grayhill can predict the switch life for the application.

Electrical Ratings

Military Qualified

The Series 53, 57 and 59 Style HS, Rotary Switches have been tested to make and break the following loads as stated in MIL-DTL-3786/36: 70,000 ft. altitude for 10,000 cycles: 10mA, 28 Vdc, inductive (250 mH); 50 mA, 28 Vdc, resistive; 20 mA, 115Vac, resistive. Atmospheric pressure, 125°C for 10,000 cycles: 25 mA, 28 Vdc inductive (250 mH); 75 mA, 28 Vdc, resistive; 50 mA, 115 Vac resistive. Atmospheric pressure, 25°C for 10,000 cycles: 75 mA, 28 Vdc, inductive (250 mH); 250 mA, 28 Vdc resistive; 150 mA, 115 Vac, resistive. Life limiting criteria for these loads are:

Contact Resistance: 50 milliohms maximum.

Dielectric Strength: 500 Vac (350 Vac—reduced pressure).

Insulation Resistance: 1,000 megohms minimum. These switches also meet MIL-DTL-3786/36 for moisture resistance, medium and high shock, vibration, thermal, thermal shock, salt spray, explosion, terminal strength and stop strength.

Materials and Finishes

Cover, Base, Spacer and Rotor Mounting Plate: Diallyl per (MIL-M-14) ASTM-D-5948

Mounting Bushing: Brass, tin/zinc-plated.

Shaft, Stop Pins, Retaining Rings, Through Bolts, Shaft Extension, Stop Arm, Thrust Washers, Lockwashers, Nuts, Non-turn Washer, Cover Plate and Rear Support Plate: Stainless steel

Detent Balls: Steel, nickel-plated

Detent Springs: Tinned music wire

Rotor Contact: Silver alloy, gold-plated .00001" minimum.

Terminals and Common Plate Including Solder Lug: Brass, gold plate .00002" minimum over silver plate .0003" minimum.

Panel Seal: Silicone rubber.

Shaft Seal: O-ring per MIL-M-5516B.

Mounting Nut, Lock Washer: Brass, tin/zinc-plated or stainless steel.

Additional Characteristics

Rotational Torque: 20-80 in.-ozs., depending on the number of poles per deck and the number of decks.

Contacts: Shorting or non-shorting wiping contacts with over 100 grams of contact force.

Shaft Flat Orientation: Flat opposite contacting position pole #1 (See Circuit Diagrams).

Extended Studs: Switches of 6 decks or more have longer studs with extra stud nuts for recommended double end mounting.

Terminals: Switch is provided with full complement of base or position terminals regardless of the number of active positions.

Rotary Switches

CIRCUIT DIAGRAMS: Series 57

Switch is Viewed From Shaft End and Shown in Position No. 1.

Note: All common terminals are located above base terminals as shown.

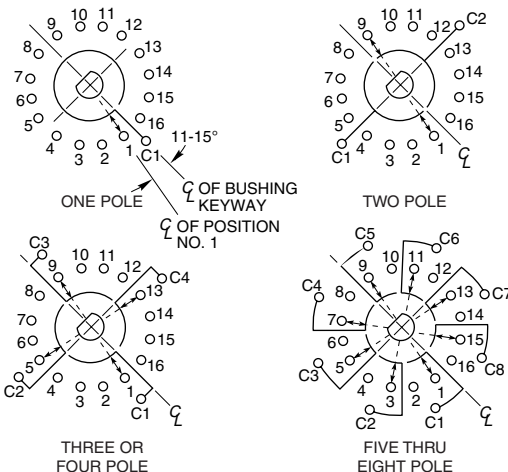

22½° Angle of Throw

Rear View

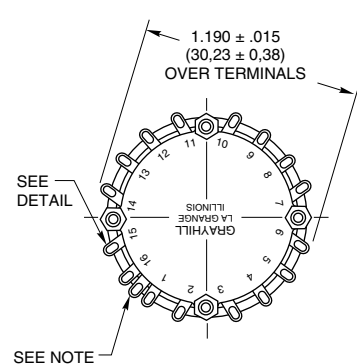

Note: Common location for a single pole per deck switch. For common location on multipole switches see circuit diagrams.

CIRCUIT DIAGRAMS: Series 57

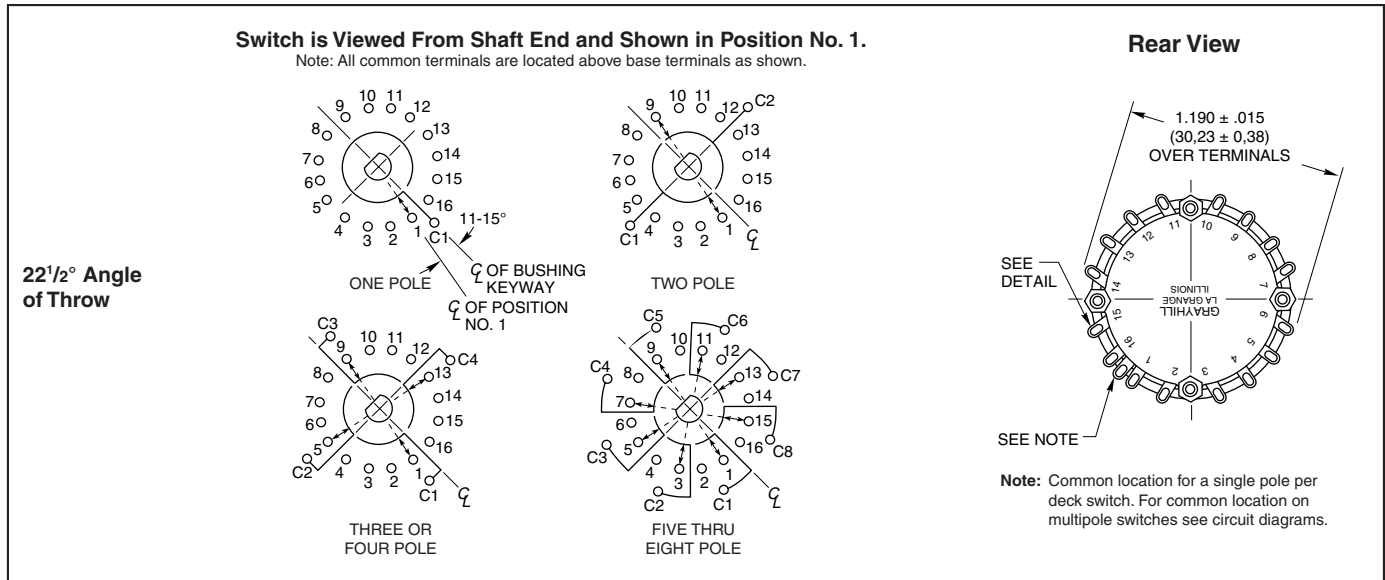

SPECIFICATIONS

Electrical Ratings

General

Switch rating for break before make contacts.

Voltage: As listed in the chart.



Curve data based on test data conducted at sea level, 25°C and relative humidity. Cycle equals 360° rotation and 360° return. Cycling rate is 10 cycles per minute. The curves shown are typical load life curves for a Series 53M, 57M and 59M Rotary Switch. They show the number of cycles of rotational life that can be expected for the voltages, currents and types of loads shown. Thus, with a 250 milliamperes, 30 Vdc resistive load, 10,000 cycles of life can be expected. Life limiting or failure criteria for these curves are:

Contact Resistance: 50 milliohms maximum (20 milliohms initially).

Insulation Resistance: 1,000 megohms minimum between mutually insulated parts.

Voltage Breakdown: 500Vac minimum between mutually insulated parts. These switches will carry 4 amperes with a maximum contact temperature rise of 20°C. If the life limiting characteristics are less critical than those shown above or if elevated temperatures or reduced pressures are involved, Grayhill can predict the switch life for the application.

Electrical Ratings
Military Qualified

The Series 53, 57 and 59 Style HS, Rotary Switches have been tested to make and break the following loads as stated in MIL-DTL-3786/36: 70,000 ft. altitude for 10,000 cycles: 10mA, 28 Vdc, inductive (250 mH); 50 mA, 28 Vdc, resistive; 20 mA, 115Vac, resistive. Atmospheric pressure, 125°C for 10,000 cycles: 25 mA, 28 Vdc inductive (250 mH); 75 mA, 28 Vdc, resistive; 50 mA, 115 Vac resistive. Atmospheric pressure, 25°C for 10,000 cycles: 75 mA, 28 Vdc, inductive (250 mH); 250 mA, 28 Vdc resistive; 150 mA, 115 Vac, resistive. Life limiting criteria for these loads are:

Contact Resistance: 50 milliohms maximum.

Dielectric Strength: 500Vac (350Vac—reduced pressure).

Insulation Resistance: 1,000 megohms minimum. These switches also meet MIL-DTL-3786/36 for moisture resistance, medium and high shock, vibration, thermal, thermal shock, salt spray, explosion, terminal strength and stop strength.

Materials and Finishes

Cover, Base, Spacer and Rotor Mounting Plate: Diallyl per (MIL-M-14) ASTM-D-5948

Mounting Bushing: Brass, tin/zinc-plated.

Shaft, Stop Pins, Retaining Rings, Through Bolts, Shaft Extension, Stop Arm, Thrust Washers, Lockwashers, Nuts, Non-turn Washer, Cover Plate and Rear Support Plate: Stainless steel

Detent Balls: Steel, nickel-plated

Detent Springs: Tinned music wire

Rotor Contact: Silver alloy, gold-plated .00001" minimum.

Terminals and Common Plate Including Solder Lug: Brass, gold plate .00002" minimum over silver plate .0003" minimum.

Panel Seal: Silicone rubber.

Shaft Seal: O-ring per MIL-M-5516B.

Mounting Nut, Lock Washer: Brass, tin/zinc-plated or stainless steel.

Additional Characteristics

Rotational Torque: 20-80 in.-ozs., depending on the number of poles per deck and the number of decks.

Contacts: Shorting or non-shorting wiping contacts with over 100 grams of contact force.

Shaft Flat Orientation: Flat opposite contacting position pole #1 (See Circuit Diagrams).

Extended Studs: Switches of 6 decks or more have longer studs with extra stud nuts for recommended double end mounting.

Terminals: Switch is provided with full complement of base or position terminals regardless of the number of active positions.

CIRCUIT DIAGRAMS: Series 53

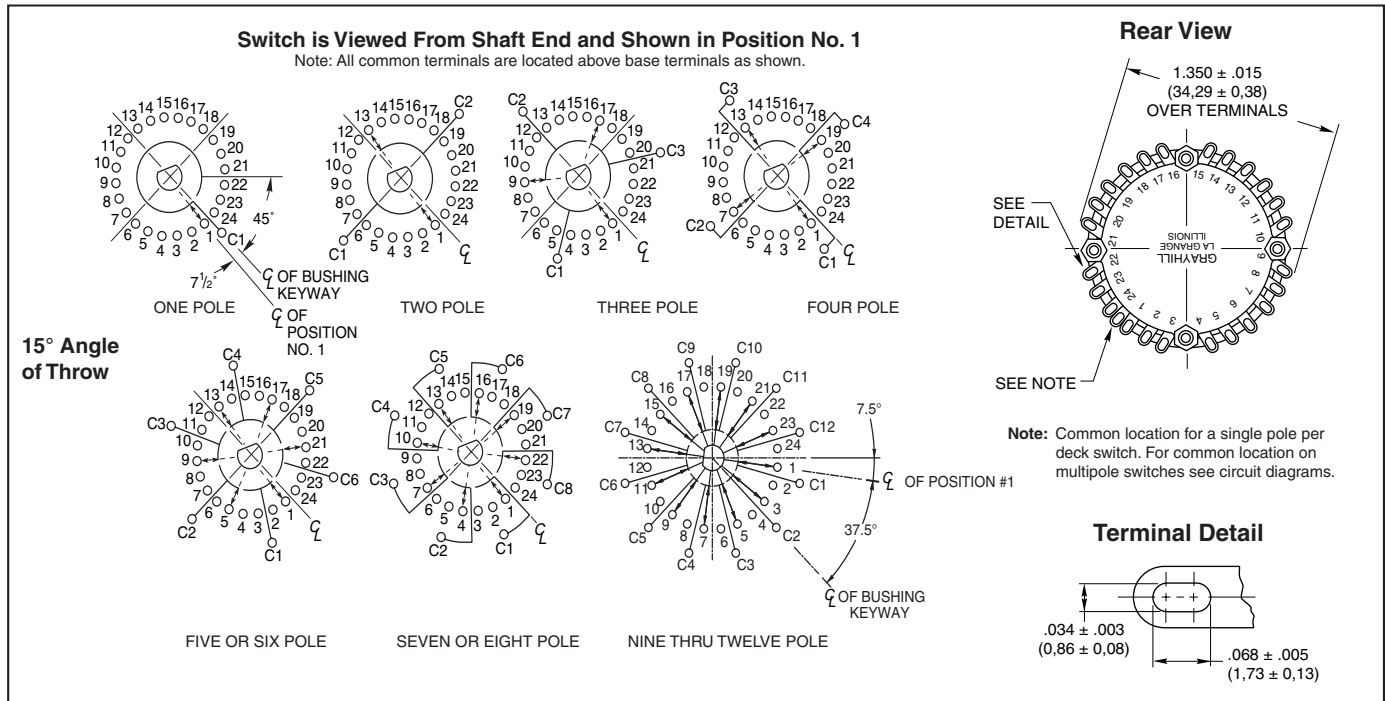

CIRCUIT DIAGRAMS: Series 59

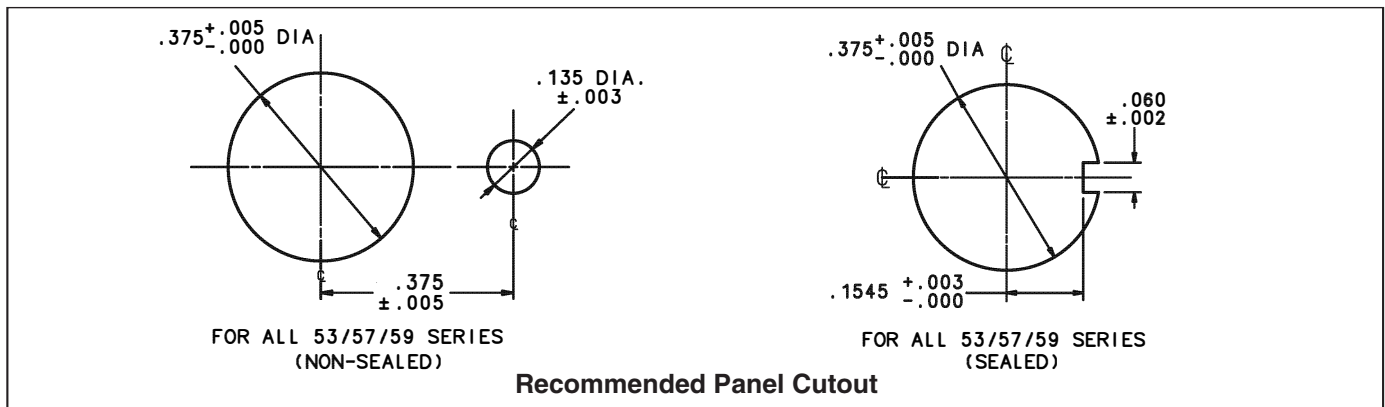
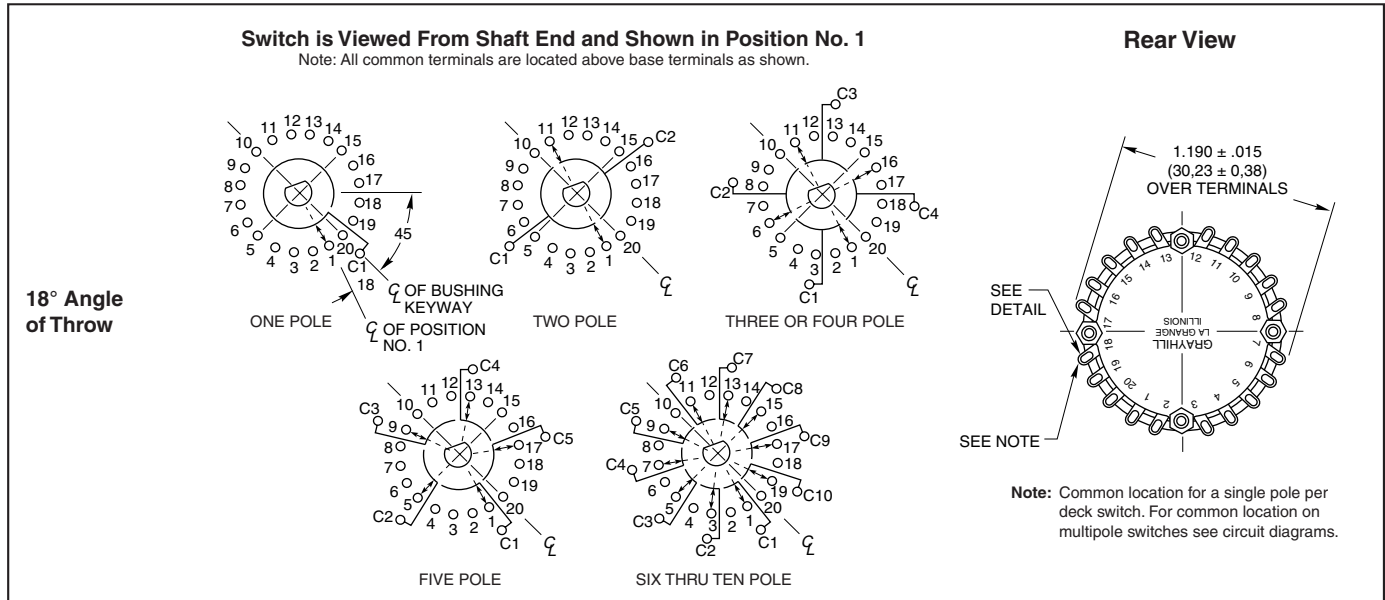

Rotary Switches

CHOICES AND LIMITATIONS

Series	Style and Designation	Angle of Throw	Stops	Terminals	Number of Decks		Poles Per Deck	Number of Positions/Pole
					Shorting	Non-Shorting		
53	M = Military Style	15°	Fixed	Solder Lug	01 thru 12	01 thru 12	1	02 thru 24
	HS = Military Qualified, Shaft/Panel Seal				01 thru 12	01 thru 12	2	02 thru 12
					01 thru 08	01 thru 08	3	02 thru 08
					01 thru 06	01 thru 06	4	02 thru 06
					01 thru 04	01 thru 04	5 or 6	02 thru 04
					01 thru 03	01 thru 03	7 or 8	02 or 03
01 or 02	01 or 02	9, 10, 11 or 12	02					
57	M = Military Style	22 1/2°	Fixed	Solder Lug	01 thru 12	01 thru 12	1	02 thru 16
	HS = Military Qualified, Shaft/Panel Seal				01 thru 12	01 thru 12	2	02 thru 08
					01 thru 06	01 thru 06	3 or 4	02 thru 04
					01 thru 03	01 thru 03	5, 6, 7 or 8	02
59	M = Military Style	18°	Fixed	Solder Lug	01 thru 12	01 thru 12	1	02 thru 20
	HS = Military Qualified, Shaft/Panel Seal				01 thru 12	01 thru 12	2	02 thru 10
					01 thru 06	01 thru 06	3 or 4	02 thru 05
					01 thru 04	01 thru 04	5	02 thru 04
					01 or 02	01 or 02	6, 7, 8, 9 or 10	02

MIL Spec. provides for qualification up to and including five decks. Switches of longer length, although not specifically qualified, are built of the same materials and are of the same construction.

ACCESSORIES

Internal Tooth Lockwasher—Figure A

For a 3/8" bushing. Approximately 0.500" (12,7) outside diameter, .022" (0,56) thickness. Material is cadmium-plated steel. **Part No. 12Q1272-1**
 For a 1/4" bushing. Approximately 0.400" (10,16) outside diameter, .018" (0,46) thickness. Material is steel, tin/zinc plated.



FIGURE A

bushing to the panel. The kit consists of four items: a grooved hex nut, a keyed washer, a keyed seal and a non-turn washer. Assembly is described on Page J-53. Dimensions of panel seal kit items are shown in Figure C. This kit seals the bushing to the panel; it does not seal the shaft to the bushing. Not usable with adjustable stop switches. **Part No. 42-24**

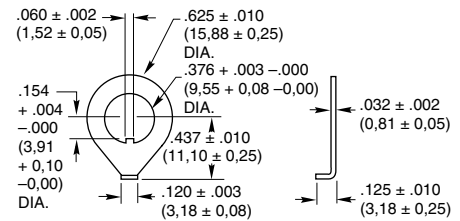
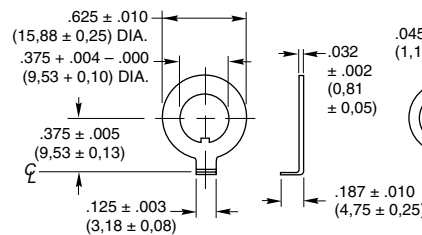

FIGURE B

Non-Turn Washer—Figure B

Can be ordered as extra hardware for the Series 5000, 24, 42, 43, 44, 54, 71B, 53, 57 and 59 rotary switches. The internal key of the washer slides into the bushing keyway. The right angle tab locks into a predrilled hole on the back side of the mounting panel. Material is brass, tin/zinc plated. **Part No. 12C1087-1**



Non-Turn Washer

Keyed Washer

FIGURE C

Panel Seal Kit—Figure C

Sold as a separate item to seal the switch

ORDERING INFORMATION

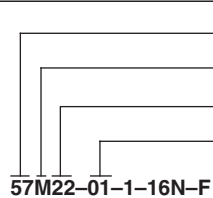

Series

Style*: Letter(s) from the Choices and Limitations chart

Angle of Throw: Must agree with Series Number

Number of Decks: As limited by Choices and Limitations chart

Stop Arrangement: Use suffix only when ordering 1 pole with maximum positions.
 F = Stop between last and first positions; C = Continuous Rotation

Type of Contacts: N = Non-shorting; S = Shorting

Positions Per Pole: requires 02 as a minimum to the maximum allowable dependent on the angle of throw and poles per deck

Poles Per Deck: As limited by angle of throw

* All rotary switches that are required to have military designated markings and testing adhering to MIL-DTL-3786 are to be ordered by specifying the military part number identified on the appropriate slash sheet.

Rotary Switches

Rotary Switch Engineering Information

Catalog Ratings

Are catalog ratings misleading? In most cases, yes. Load and life ratings shown in most catalogs are usually invalid for most applications. This results from the complex interplay of such factors as environment, duty cycle, life limiting or failure criteria, actual load, etc. Circuit designers should be aware of these factors, and the effect they have on the useful life of the switch in their applications.

The problem of switch rating arises from the wide variety of requirements placed on the switch. This includes various applications, and the sensitivity of the switch to a change in requirements. If we attempted to establish life ratings for all possible applications, we would have an almost infinite variety of ratings.

To simplify the problem, switch manufacturers, switch users, and the military, have established certain references for ratings. These include loads, life requirements, environments, duty cycles, and failure criteria. These references are arbitrarily established. But, they allow you to compare different switch designs. They do not, however, match the actual requirements for most applications.

The curves shown here are an example of some of the life load curves. These curves are life load characteristics of the Grayhill 42M and 44M switches. Note that the curves consider only two voltage sources and two types of loads. These voltages and loads are, however, considered as standards for testing procedures by the industry.

Curve data is based on tests conducted at sea level, 25°C and 68% relative humidity. Cycle = 360° rotation and return. Cycling rate is 10 cycles per minute. Switch rating is for non-shorting contacts.

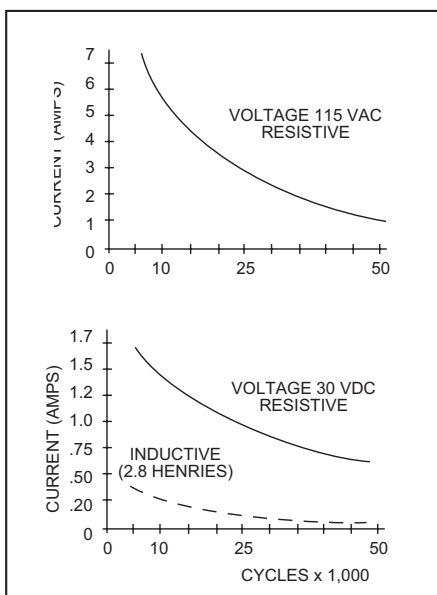

These curves allow you to predict the expected life of the switch once you know the voltage, current and type of load. Also note that each cycle is approximately a 360° rotation and a return. For a ten position switch this would be a rotation from position 1 to position 10 and back to 1. This cycle runs approximately ten times a minute. Thus testing causes more electrical and mechanical wear than what the switch incurs in actual use.

Summary

The life and load ratings in this and other catalogs are probably not totally valid for your application. The bright side of the picture is that in most applications the switch will perform better than its ratings. This is because the standard industry test conditions are more stringent than those found in most applications.

This difference can be very dramatic. For example, Grayhill's 42A and 44A Series Rotary Switches, are rated at 1 ampere (115 Vac resistive). However, they will operate at 5 amperes in many applications. To see how some major factors influence switch performance, read on.

USEFUL LIFE CRITERIA

The "useful" life of a switch in your application depends on what you demand of it. This includes parameters such as contact resistance, insulation resistance, torque, detent feel, dielectric strength, and many other factors. For example, a contact resistance of 50 milliohms may be totally unusable in certain applications such as a range switch in a micro-ohm meter. In other applications a contact resistance of 5 ohms may be perfectly satisfactory.

In establishing "useful" life for a switch in your application, you must first determine "failure criteria," or "end of life" parameters. At what level of contact resistance, dielectric strength, etc., is the switch no longer acceptable for your application?

Most switches are acceptable on all parameters when new. There is a gradual deterioration in performance with life. The rate of deterioration varies greatly with basic switch design. Often, circuit designers select a switch on the basis of its performance when new. This is a mistake. The performance of the switch after several years of equipment use is more significant. To estimate this, first determine the life limiting or failure criteria for your application. In most uses, important life-limiting (failure) criteria include the following parameters:

- Contact Resistance
- Insulation Resistance
- Dielectric Strength
- Actuating Force

Contact Resistance

This is the resistance of a pair of closed contacts. This resistance effectively appears in series with the load. Typical values are in the range of a few milliohms for new switches. These values usually increase during life. The rate of increase is greatly affected by the voltage, current, power factor, frequency, and environment of the load being switched. Typical industry standard "end of life" criteria for this parameter are:

MIL-DTL-3786:	20 milliohms (Rotary Switches)
MIL-S-6807:	20 milliohms (Snap Pushbuttons)
MIL-S-8805:	40 milliohms (Pushbuttons)
MIL-S-83504:	100 milliohms (DIP Switches)

Contact resistance can be measured by a number of different methods. All of them are valid depending upon the switch application and the circuit. Grayhill uses the method in applicable military specifications. This method specifies an open circuit test voltage and a test current. The voltage drop across the closed contacts is measured. The contact resistance is determined by Ohm's Law from the test current and the measure voltage drop. MIL-DTL-3786, MIL-S-6807 and MIL-S-8805 require a maximum open circuit test voltage of 2 Vdc; they require a test current of 100 milliamperes. MIL-S-83504 requires a maximum test voltage of 50 millivolts and a test current of 10 milliamperes.

When a switch is rated to make and break 5 or more amperes, there is a difference. Contact resistance is determined by measuring the voltage drop while the switch is carrying the maximum rated current.

The voltage drop that occurs across the contacts determines, in part, the contact temperature. If the temperature rise of the contacts is sufficient, it affects contact material. A chemical reaction will take place that can cause an insulating film to appear on the contacts. This film is present between the contacts during the next switching operation. This film formation can cause failure due to increasing contact resistance. For switching of very low voltages and currents, this resistance may be the failure criteria.

Insulation Resistance

This is the resistance between two normally insulated metal parts, such as a pair of terminals. It is measured at a specific high DC potential, usually 100 Vdc or 500 Vdc. Typical values for new switches are in the range of thousands of megohms. These values usually decrease during switch life. This is a result of build-up of surface contaminants. Typical industry standard "end of life" criteria for the parameter are:

MIL-DTL-3786:	1000 megohms (for plastic insulation)
MIL-S-6807:	Not specified
MIL-S-8805:	2000 megohms
MIL-S-83504:	1000 megohms

Another special test condition is commonly specified. It measures insulation resistance for switches in a high humidity atmosphere (90%-98% R.H.). In this condition, condensation of moisture commonly occurs on the surface of the insulating material. Some types of insulation will absorb varying amounts of moisture. This will normally lower the insulation resistance. Typical industry values for this condition are:

MIL-DTL-3786:	10 megohms (for plastic insulation)
MIL-S-6807:	3 megohms after drying
MIL-S-8805:	10 megohms (for plastic material)
MIL-S-83504:	10 megohms

Dielectric Strength

This is the ability of the insulation to withstand high voltage without breaking down. Typical values for new switches in this test are in excess of 1500 Vac RMS. During switch life, contaminants and wear products deposit on the surface of the insulation. This tends to reduce the dielectric withstanding voltage. In testing for this condition, a voltage considerably above rated voltage is applied. Then, the leakage current is measured at the end of life. Typical industry standard test voltages and maximum allowable leakage currents are as follows:

MIL-DTL-3786:	1000 Vac and 1 mA maximum leakage
MIL-S-6807:	600 Vac RMS after life 10 microamperes maximum leakage
MIL-S-8805:	1000 or 1000 plus twice working voltage (AC) RMS and 1mA maximum leakage
MIL-S-83504:	500 Vac and 1 mA maximum leakage
UL Standard:	900 Vac without breakdown (UL Standard (dependent on test)

Voltage breakdown is another method for

describing the ability of the insulating material to withstand a high voltage. Voltage breakdown describes the point at which an arc is struck and maintained across the insulating surface with the voltage applied between the conducting members.

ADDITIONAL LIFE FACTORS

Effect of Loads

On any switch, an arc is drawn while breaking a circuit. This causes electrical erosion of the contacts. This erosion normally increases contact resistance and generates wear products. These wear products contaminate insulating surfaces. This reduces dielectric strength and insulation resistance.

The amount of this erosion is a function of current, voltage, power factor, frequency and speed of operation. The higher the current is, the hotter the arc and the greater the erosion. The higher the voltage is, the longer the arc duration and the greater the erosion.

Inductance acts as an energy storage device. This returns its energy to the circuit when the circuit is broken. The amount of erosion in an inductive circuit is proportionate to the amount of inductance. Industry standard test inductance as described in MIL-I-81023 is 140 millihenries. Other test loads include 250 millihenries and 2.8 henries.

Frequency can also affect erosion. The arcing ends when the voltage passes through zero. To a certain extent, the following is true. The higher the frequency, the sooner arcing ends, the lower the erosion.

The speed of operation affects the duration of the arc. Fast operation can extinguish the arc sooner. This reduces the erosion, unless the air within the switch is completely ionized.

Actuating Force

Rotational torque is the actuating force required to turn a rotary switch through the various positions. The actual torque or force required depends on the design of the switch. It varies widely from one design to another. See appropriate MIL Specs or manufacturers literature for typical industry values for specific designs.

When torque or force values are specified, it is customary to give a minimum and maximum value. During life, two offsetting factors may occur to change the initial value. Relaxation of spring members will tend to lower torque or force values. Wear or "galling" of mating surfaces, however, may tend to increase these values. Typical end of life specifications may require the switch to fall within the original range. Or, they may specify a maximum percentage change from original value. For example, "the rotational torque shall not change more than 50% from its initial value."

Effect of Ambient Temperature

Temperature extremes may affect switch performance and life. Very high temperatures may reduce the viscosity of lubricants. This allows them to flow out of bearing areas. This can hasten mechanical wear of shafts, detents, plungers, and cause early mechanical failure. Contact lubricants are sometimes used. Too little lubrication can result in a high rate of mechanical wear. Too much lubrication flowing from other bearing areas can adversely affect dielectric strength and insulation resistance.

Through careful design and selection of lubricants most manufacturers attempt to minimize these affects. Nevertheless, continual operation in high ambient temperatures will shorten the life of a switch regardless of design.

Extremely low ambient temperatures may also create problems. Low temperatures may cause an increase in the viscosity of the contact lubricant. Higher viscosity can delay or prevent the closing of contacts, causing high operating contact resistance. Under certain atmospheric conditions, ice may form on the contact surfaces. This also causes high and erratic contact resistance.

Neither of these conditions may materially reduce the life of the switch. However, it may cause unsatisfactory operation. If the voltage of the circuit is high enough, it can break down the insulating layer. Some current will flow through the high resistance contacts. A local heating action is created, which tends to correct the condition in a short period of time.

Switches with high contact pressures may minimize the low ambient temperature effect. This is particularly true if the application calls for switching signal level voltages and currents.

Effects of Altitude

In high altitudes, barometric pressure is lower. Low pressure reduces the dielectric strength of the air. The arc strikes at a lower voltage and remains longer. This increases contact erosion. Switches for use in high altitudes will therefore require derating in terms of loads and/or life.

Effects of Duty Cycle

Mechanical life testers cause accelerated life testing. Testers operate switches at a rate of approximately 10 cycles per minute. This rate is greatly in excess of normal manual operation in equipment. It constitutes a severe test of the switch.

Lubricants do not have an opportunity to redistribute themselves over the bearing surfaces at this duty cycle. The contact heating caused by arcing does not have a chance to dissipate.

Thus, the switch runs "hot", increased mechanical wear and contact erosion result. Your application probably requires manual operation of the switch with an attendant low duty cycle. If so, you can usually expect much longer switch life than is shown by the accelerated life laboratory life tests.

Conclusion

Remember, load and life ratings are based on manufacturers' selected references. They include accelerated life tests and an arbitrary set of application parameters and failure criteria. These parameters and criteria may not always fit your application.

Then how do you know if a switch will give reliable performance in your application?

How do you know if it will last the life of your equipment?

Ask the switch manufacturer. Grayhill, and most other reputable manufacturers have compiled vast quantities of test data. We are in a position to give a good estimate of a switch's performance in many nonstandard applications. You should provide the following data:

Expected Life:	in number of cycles
Load:	voltage, current, power factor, and frequency
Operation:	manual or mechanical, duty cycle
Application:	type of equipment
Environment:	altitude, ambient temperature range, relative humidity, corrosive atmosphere, shock, vibration, etc.
Failure Criteria:	end of life contact resistance, dielectric strength, insulation resistance, etc.

With this information, we can usually estimate if a given switch is suitable for your application.

Soldering

What causes failure in a new switch after it has been installed? The principle failure is high contact resistance caused by solder flux on the contact surfaces. To avoid this, be sure to follow good soldering practices. Use the proper solder with the proper flux core, maintain the proper soldering temperature, use the proper soldering iron tip for the work, and never use liquid flux when soldering a switch.

Do not use solvent baths or washes with any unsealed electromechanical parts. Switches, unless they have been especially protected suffer badly. Solvents readily dissolve fluxes and carry them into the contact area of switches. A thin, hard flux coats the contact surface after the solvent evaporates. Additionally, solvents may dissolve and wash away lubricants in switches. Lubricant loss may prevent proper mechanical action.

Exercise similar precautions when you mount a switch to a printed circuit board. Maintain proper solder temperatures and follow proper cleaning techniques. Avoid subjecting these switches to lengthy solder baths. The excessive heat can deform the plastics.

RFI/EMI Shielding

Some applications require shielding against Radio Frequency Interference and/or Electro-Magnetic Interference. Experts feel that the most effective way to achieve shielding is to provide a conductive bridge across the component mounting hole. They also generally agree that there is no good method for testing shielding. So, the equipment manufacturers themselves must identify and solve specific problems. Component manufacturers can generally assist in the solution of shielding problems.

RFI/EMI testing is incorporated into MIL-DTL-3786 for rotary switches. Requirements are 1.0 ohm maximum dc resistance between the mounting bushing and operating shaft

initially and 10.0 ohm maximum dc resistance following environmental and mechanical tests. Many equipment manufacturers feel they are satisfying their needs with a measurement of .025 to 10 ohms for the expected life of the switch. Under most circumstances, standard non-sealed switches pass the larger value easily. The lower value (.025 ohms) requires special attention and parts for compliance over the life of the switch.

Switch Selection

Whenever possible, use standard switches and contact configurations. Standards provide the greatest economy and the best delivery. When you need a deviation, it pays to consult with your suppliers as soon as possible. At the early stages of the design, there are many low cost options for achieving the results. At the late stages of design, some of the options may no longer be open. For example, size may be restricted. This might result in a more costly redesign.

Typical standard rotary options are as follows: coded contacts, homing rotor effect, progressively shorting contacts, PC mountable terminals, rotary switch spring return positions, and push-to-turn or pull-to-turn mechanisms.

Limited panel space may be solved by a concentric shaft rotary switch. It is two rotary switches, located one behind the other. There are other concentric shaft possibilities. A rotary switch can be combined with another component. These include a potentiometer, a pushbutton switch, and a mechanical element. The most cost effective design may be one of these concentric options. But, selection must be made at the outset of equipment design.



1. SELECT A FACTOR

FACTOR: Current Life Rating

All switches are rated to make and break at least 100 milliamperes for 10,000 cycles of operation. Rating becomes a matter of interpretation. Carefully review the Engineering Information on the previous pages. Ratings which assure a different life are possible; contact Grayhill.

	Single Deck Switch Series							Multi-Deck Switch Series				
	19	24	50/51	56	75	77	5000	08/09	42/44	43/54	53,57,59	71
25,000 Cycles At Load (Amps)	—	1	.050	—	—	.050	1	.250	1,3,5*	1,3,5*	—	.250
10,000 Cycles At Load (Amps)	—	—	.200	.200	.100	—	—	.500	1,3,5*	1,3,5*	.150, .250*	—
6,000 Cycles At Load (Amps, UL)	15	—	—	—	—	—	—	—	—	—	—	—

* Varies with angle of throw and style.

FACTOR: Size

Maximum Dimension In Inches (& Millimeters)	Single Deck Switch Series								Multi-Deck Switch Series							
	19	24	50	51	56	75	77	5000	08	09	42	44	53	57	59	71
Diameter, Behind Panel	2.280	1.015	.500	.561	.500	.298		1.015	.687	.750	1.015	1.170	1.350	1.190	1.190	.750
Length Behind Panel, 1 Deck	.950	.580	.698	.698	.355	.500		.470	.960	.960	1.025	1.025	.916	.916	.916	.760
Behind Panel, Add'l Deck	—	—	—	—	—	—	—	—	.268	.268	.346	.346	.329	.326	.326	.218
Diameter, Behind Panel	(57,9)	(25,8)	(12,7)	(14,2)	(12,7)	(7,6)	()	(25,8)	(17,4)	(19,0)	(25,8)	(29,7)	(34,3)	(30,2)	(30,2)	(19,0)
Length Behind Panel, 1 Deck	(24,1)	(14,7)	(17,7)	(17,7)	(9,0)	(12,7)	()	(11,9)	(24,4)	(24,4)	(26,0)	(26,0)	(23,3)	(23,3)	(23,3)	(19,3)
Behind Panel, Add'l Deck	—	—	—	—	—	—	—	—	(6,8)	(6,8)	(8,8)	(8,8)	(8,4)	(8,3)	(8,3)	(5,5)

* If multi-deck switch is needed, contact Grayhill.

FACTOR: Circuitry

Max. Positions 1 Deck (1Pole)*	Angle Of Throw	Maximum Decks**	Maximum Poles Per Deck***	Shorting Or Non-Shorting	Solder Lug Or PC	Series Number
24	15°	12	12	N or S	Solder	53
20	18°	12	10	N or S	Solder	59
16	22°30'	12	8	N or S	Solder	57
16	22°30'	1	2	N or S	Both	51
12	30°	12	6	N or S	Both	71
12	30°	12	6	N or S	Both	9
12	30°	12	6	N or S	Solder	44
12	30°	1	4	N or S	Both	51
12	30°	1	4	N or S	Both	56
11	30°	1	1	N	****	19
10	36°	12	2	N or S	Both	8
10	36°	12	2	N or S	Both	71
10	36°	12	2	N or S	Both	42
10	36°	1	2	N	PC	75/77
10	36°	1	2	N or S	Both	50
10	36°	1	2	N or S	Both	56
10	36°	1	1	N or S	Both	24
10	36°	1	1	N or S	Solder	5000
8	45°	12	4	N or S	Both	9
8	45°	12	4	N or S	Solder	44
8	45°	1	2	N	Both	50
6	60°	6	3	N	Both	9
6	60°	12	3	N	Solder	44
6	60°	1	2	N	Both	50
4	90°	12	2	N	Solder	44
4	90°	6	2	N	Both	9
4	90°	1	2	N	Both	50

* Maximum positions per pole depends on number of poles per deck.

** Based on 1 pole per deck. Number of decks is also limited by the total number of poles.

*** Limited by total number of poles per switch.

****Choice of Faston or Solder Lug terminals.



Rotary Switch Standard Options

- Custom Switches With No Tooling Required
- Easily Ordered Specials

1. Dummy Terminal

Used as tie point, it is not an active switch position. Can be located at any specified position outside of active switch terminals. Priced as active position. Example, a three position switch with 2 dummy terminals would be priced as a five position switch.

2. Enlarged Wire Holes

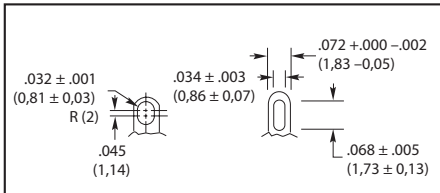

Series 08A, 09A, 42H, 42M, 44H, and 44M: Lug terminals for several wires; standard in Series 08M, 09M, 53, 57, and 59 switches.

3. High Density Wiring Terminal

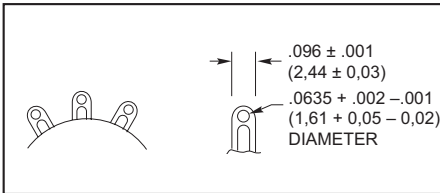

The gold-plated terminal features a slot to accept wires in addition to the conventional wire hole.

4. Taper Tab Terminals

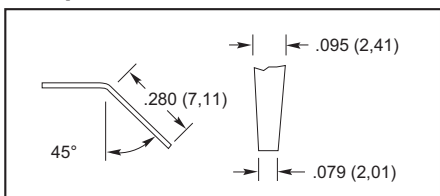

Used in place of conventional solder lug terminals. Taper tab terminals are gold plated.

5. Notched Terminals

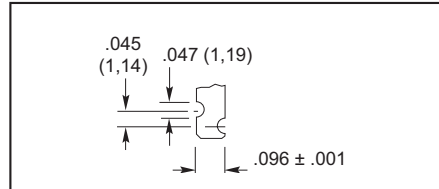

Used in place of the conventional solder lug terminals.

6. External Shorting Links

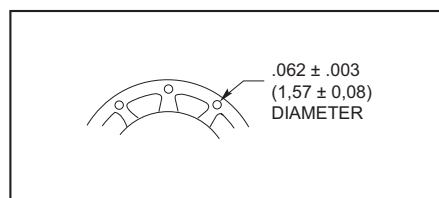

External shorting links, as shown in the drawing, can be used in place of conventional solder lug terminals in the Series 5000, 24, 42 or 43 rotary switches. Shorted terminals can also be accomplished internally in the Series 71 rotary switches. Solder lug terminals can be intermixed on the same deck.

7. Non-Standard, Non-Turn Devices

Switches without tabs
Series 08, 09, 42 and 44: There is no additional charge for a front support plate without a non-turn tab.

Non-turn tab of non-standard projection Series 08:

All tabs located at .260 inch radius from centerline of switch. The following projections (inches) are available: .121; .094; .045; .032
Series 44:

From Centerline	Projection
.375" (9,53 mm)	.062" (1,57 mm)
.531" (13,49 mm)	.121" or .049" (3,07 or 1,24 mm)

8. RF1 Grounding

A silver-plated shaft and wave washer improve DC grounding of shaft to mounting bushing, thus minimizing possible radio frequency interference. Example: static and dynamic DC resistance after 25,000 cycle life test is maximum 100 milliohms. For concentric shaft switches, discuss grounding with factory. Special handling charges apply to small lots.

9. Electrostatic, Electromagnetic Shielding

A metallic shield can be added between decks. Grounding of the shield provides additional RFV /EMI protection. Size and shape of the shield depends on the equipment configuration and the amount of protection required Price is dependant on the number and type of shields required.

10. Unidirectional Rotation

The detenting system permits rotation in only one direction. Usable only with continuous rotation switches. Specify direction of rotation. Applicable to 30° and 36° throw switches only.

Switch Series#	Options For Styles A and S								Options For All Styles							
	1	2	3	4	5	6	7	8	9	10	11	12	13	14	15	16
08	x	x					x	x			x	x				
09	x	x					x	x			x	x				
24	x		x	x	x	x		x								
42	x	x*	x	x	x	x	x	x	x	x	x	x				
43	x		x	x	x	x		x*			x			x	x	
44	x	x*	x	x	x		x	x	x	x	x		x			
50/51								x			x					
56								x			x					
53/57/59								x								
54	x		x	x	x			x*			x			x	x	x
71								x*	x		x					
5000	x		x	x	x	x		x								

* See description below for limitations.



11. Intermixing of Shorting and Non-Shorting Contacts

In some switches, non-shorting and shorting contacts can be intermixed between decks. A 2-deck switch, for example could have shorting contacts on deck 1 and non-shorting contacts on deck 2. In a few switches, non-shorting and shorting contacts can also be intermixed between poles. A 2-pole per deck switch, for example, could have non-shorting on pole #1, and shorting on pole #2.

Series 08 and 09:

An 09M30 or 08M36 rotary switch can have shorting and non-shorting contacts intermixed between decks. Shorting and non-shorting contacts can be intermixed between poles as well as decks in styles A, S, P, and SP.

Series 42, 43, 44, and 54, in 30° or 36°:

Non-shorting and shorting contacts can be intermixed between poles or decks.

Series 50, 51, and 56:

Non-shorting and shorting contacts can be intermixed between poles.

Series 71:

Non-shorting and shorting contacts can be intermixed between poles in fixed stop switches only.

Priced the same as standard switches. The type of contacts on each pole must be precisely indicated.

12. PC Mount Switches With Terminals From One Side of Switch

Series 71 PC mount switch has all terminals on one side.

Series 08P, 09P, and 42P with non-shorting contacts are also available with terminals limited to one side. Contact Grayhill for a special part number. This is accomplished by using 2 decks per pole and placing the rotating contacts 180° out of phase on each deck. The first deck picks up the first half of the positions; the second deck picks up the last half of the positions. Common terminals are tied together by the PC board circuitry.

A total of 12 decks (6 usable poles) is the maximum per switch. Switches with the maximum number of positions (12 for 30°, or 10 for 36°) will have continuous rotation. Rotation can be limited to less than the maximum positions. For example, an 8 position Series 8P36 switch with terminals on one side, would pick up 5 positions on the first deck and 3 positions on the second deck.

Price is the same as standard switches with comparable number of decks and positions.

Example: an 08P36, 1-pole, 10 position switch with terminals on one side of the switch would be priced as a 2 deck, five position, one pole per deck switch.

13. Homing Rotor (Bridging and Shorting Deck) and Progressively Shorting Deck - Series 44 only

A homing rotor (bridging and shorting) switch deck connects all terminals to the common except the terminal in the selected switch position. For example, in position 1, terminals 2 thru 12 are

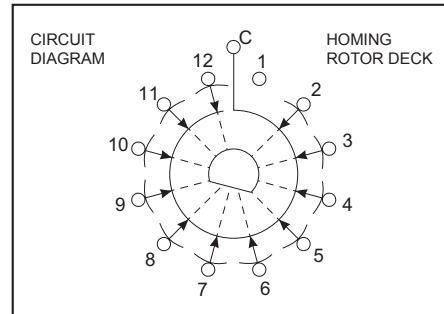

connected to the common, and terminal 1 is open. In position 2, terminal 3 thru 12 and 1 are connected to the common, and terminal 2 is open. A homing rotor deck will function for 25,000 mechanical cycles of operation.

The progressively shorting switch deck connects consecutive switch positions to the common. For example, in position 1, terminal 1 is connected to the common; in position 2, terminals 1 and 2 are connected to the common; in position

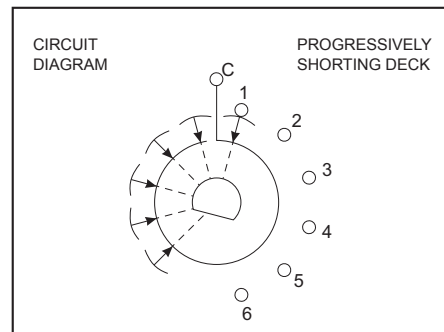

3, terminals 1,2, and 3 are connected to the common. A progressively shorting deck is limited to a maximum of 6 positions. A progressively shorting deck will function for 25,000 mechanical cycles of operation.

Homing Rotor or Progressively Shorting decks can be ordered as a deck of a 44A or 44M style switch, or their sealed equivalents. Order up to 11 conventional decks and 1 special circuitry deck. For a good detent feel, the switch is limited to a total of 12 poles plus the homing rotor or progressively shorting deck. Example: 6 2-pole decks and a homing rotor. When these special

decks are used in combination with conventional decks, it is important to remember that the stop system limits the rotation of both types of decks. For example, when a homing rotor deck is used in combination with a 6-position conventional deck, the homing rotor is likewise limited to six positions.

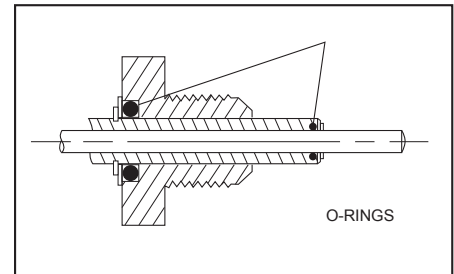

14. Shaft and Panel Seal on Concentric Shaft Switches

The following diagram shows the location of the O-rings required to seal the shafts to the bushings. When the concentric shaft switches are sealed in this manner, the .125 inch diameter shaft is supplied full round. Bushing-to-panel sealing is accomplished by the panel seal kit.

15. Fixed Stop, Add-A-Pot Switches

The rotary switch section of the Add-A-Pot rotary switches can be built with a fixed mechanism rather than the standard adjustable stop mechanism. The front end of a switch of this type is similar to the Series 43A or Series 54A style concentric rotary switches. The total number of decks is limited to three. The Series 43 is limited to 1 pole per deck. Series 54 to 2 poles per deck.

16. Series 54 Concentric Shaft Switch in 45°, 60°, and 90° Throws

The Series 54A switch is available with these angles of throw in Section A of the concentric rotary switch. Section B is available in 30° angle of throw only. Section A is limited to 1 to 3 decks, non-shorting contacts, and 1 or 2 poles per deck.