

SPUBAT DIN Rail Battery Rack

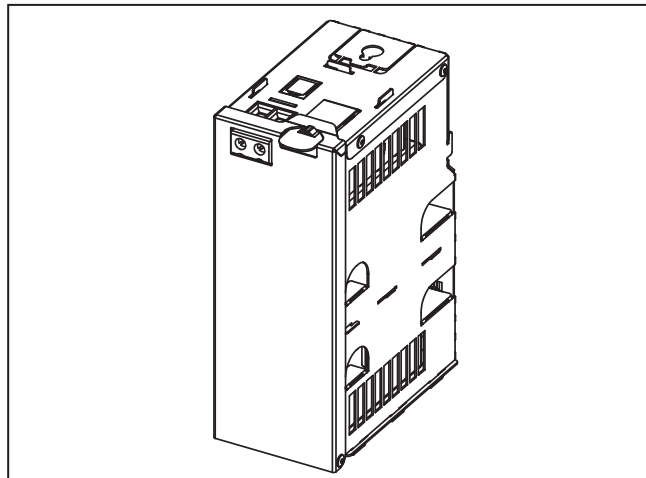

- DIN Rail Rack for batteries
- Available with VRLA battery
- Supports for wall mounting
- Easy battery access
- IP20
- Built in terminals

Ordering Key

SPUBAT 24 1A2

DIN Rail Rack _____
 Battery Voltage (if present)¹ _____
 Battery capacity rack size _____

¹ When battery voltage is not present the rack is without battery

Accessory: Protection Fuse Flat Type Mini 25 A

Product Description

SPUBAT is a series of metal racks that facilitate the battery mounting next to the UPS, either on the DIN rail or wall mounted. SPUBAT can be delivered with the battery already installed, or as an empty rack for other battery types selected by the installer. Standard battery type is AGM Valve Regulated Lead Acid (VRLA). It requires no maintenance and

can be mounted in any position. This type of batteries are ideal for applications where it is required high starting current. They also have extreme resistance to charge / discharge cycles. Body is very robust, stainless steel made. It is equipped with connection terminals for fast connection and disconnection in case of need.

Technical Data

Nominal voltage	24V
Battery capacity	
1A2	1.2Ah
3A2	3.2Ah
7A2	7.2Ah
12A	12Ah

Battery type	AGM VRLA
Protection fuse	Flat type mini 25A
Recovery fuse	Flat type mini 25A

Charging

End of charge voltage (trickle)	
@20°C	27.5VDC
@30°C	26.8VDC
@40°C	26.1VDC
Max Charging current	
1A2	0.36A
3A2	0.9A
7A2	2.16A
12A	3.6A

Discharging

Max discharging current	25A
Self discharge at 20°C	15%/month

Norms and Certification

-	-
---	---

General Data

Protection degree	
EN/IEC 60529	IP20
Protection class	III
Screw terminals connection	
Threaded wire	0.5-16 mm ² / AWG 20 to AWG 6
Dimension (WxHxD)	See table p. 3

Weight	See table p. 3
DIN Rail Mounting	Yes
Wall mounting	Yes
Ambient temperature op:	0 ... 40°C
Temperature storage	0 ... 40°C
Humidity at 25°C, no condensation	95%

Buffering Time (min.)

Battery type	1A2	3A2	7A2	12 Ah
Load 1.5 A	20	60	200	400
Load 3 A	8	30	120	240
Load 5 A	3	15	55	100
Load 7.5 A	2	10	30	60
Load 10 A	No	7	20	45
Load 12 A	No	3	12	30
Load 15 A	No	No	9	20
Load 20 A	No	No	7	13

Internal Electrical Diagram

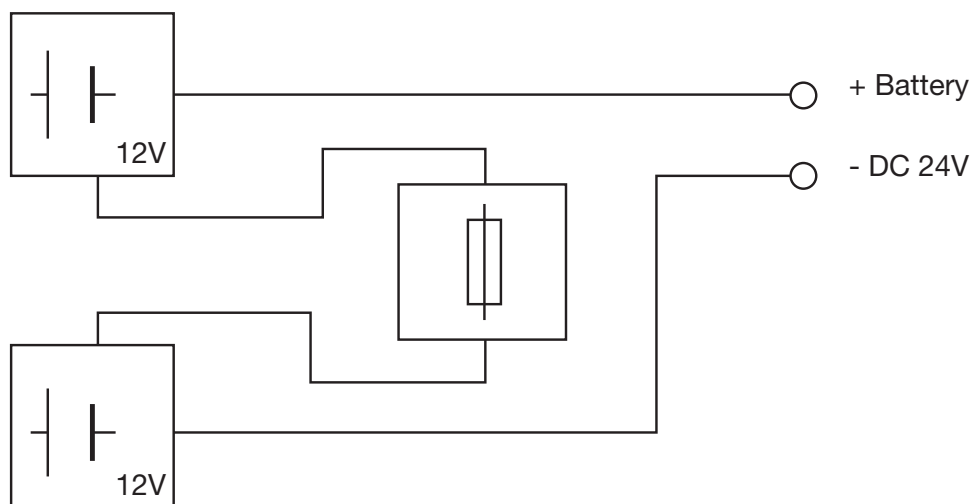

Dimensions SPUBAT 241A2

Wall Mount

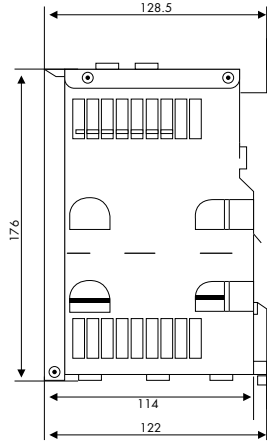
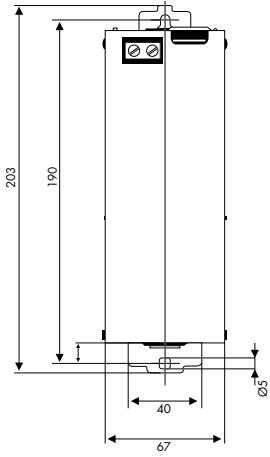

DIN Rail Mount

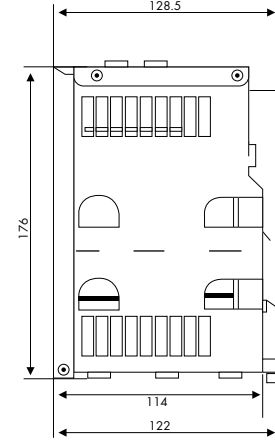
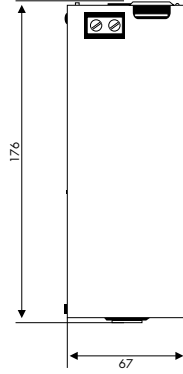

Dimensions SPUBAT 243A2

Wall Mount

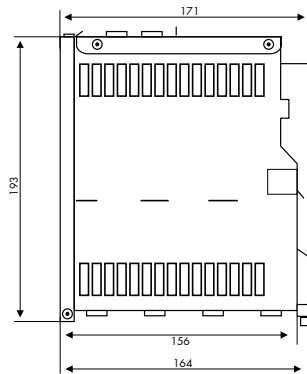
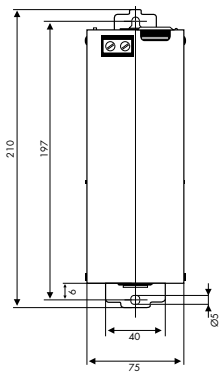

DIN Rail Mount

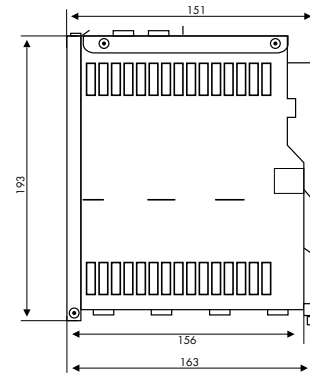
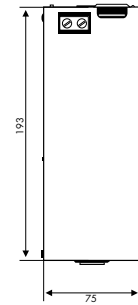

Dimensions SPUBAT 247A2

Wall Mount

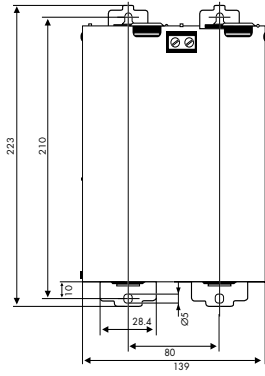

DIN Rail Mount

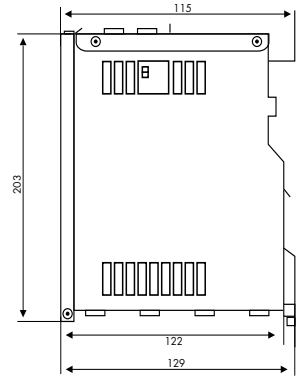
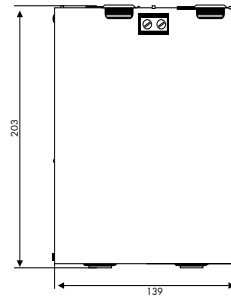
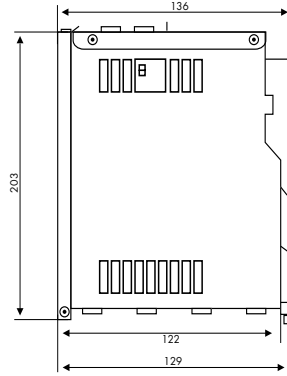

Dimensions SPUBAT 2412A

Wall Mount

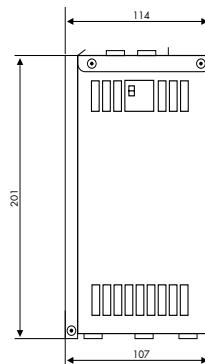
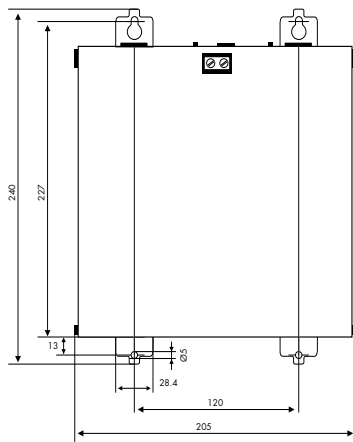

Dimension & Weight Table

Model	Dimensions W x H x D	Weight
SPUBAT241A2	62 x 175 x 120 mm	1.5 Kg
SPUBAT243A2	82 x 200 x 160 mm	3 Kg
SPUBAT247A2	145 x 210 x 130 mm	5.5 Kg
SPUBAT2412A	210 X 210 X 210 mm	9 Kg