

Motor Controllers AC Variable Frequency Drives Type VariFlex³ RVFF

CARLO GAVAZZI



- AC variable speed drive for use with AC induction motors
- Sensorless vector control or V/F, SLV, PMSLV with space vector PWM mode
- Input voltage ranges: 3-ph 480VAC
- 150%/1Hz (vector mode) starting torque
- Simple built-in PLC function always available
- PID function available
- Conforms to EMI radio standard and EMS immunity standard EN 61800-3 for the second environment (Industrial sites)
- All parameters accessible both via keypad and PC
- 6 different physical frame sizes
- RS485 Modbus RTU/ASCII serial communications available on all models through an option card
- Speed setting by buttons and knob
- Copy module option for fast and accurate drive to drive parameter transfer and storage
- NPN/PNP digital inputs
- DIN rail or panel mounting and keypad extension available on all models
- Communication interface modules for Profibus/DeviceNet/Ethernet (TCP/IP)/CANopen/BACnet

Product Description

The VariFlex³ RVFF is a simple, compact and general purpose AC variable speed drive for use with 3-phase AC induction motors. Parameters are logically divided in to fifteen different groups for simple and immediate setting of the devices according to the needs of the process. Via an extension cable, the standard display can be placed outside the cabinet where the drive is installed.

The RVFF is a complete family of inverters ranging from 3.7kW/5HP up to 160kW/215HP with three phase AC input 480VAC. The VariFlex³ employs state of the art microprocessor digital technology which controls all drive functions. All printed circuit boards are coated and manufactured using surface mount technology, ensuring the high quality and reliability of the units.

Ordering Key

RVFF A 3 40 2200 F

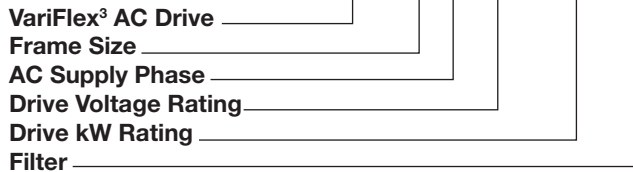

Approvals



Type Selection

Frame Size	AC Supply Phase	Drive Voltage Rating	Drive kW Rating	Filter	
A: Size 1 B: Size 2 C: Size 3 D: Size 4 E: Size 5 F: Size 6	3: 3-Phase	40: 380 - 480VAC	0400: 3.7kW, 5HP	F: Built-in EMI filter	
			0550: 5.5kW, 7.5HP		
			0750: 7.5kW, 10HP		
			1100: 11.0kW, 15HP		
			1500: 15.0kW, 20HP		
			1850: 18.5kW, 25HP		
			2200: 22.0kW, 30HP		
			3000: 30.0kW, 40HP		
			3700: 37.0kW, 50HP		
			4500: 45.0kW, 60HP		
			5500: 55.0kW, 75HP		
			7500: 75kW, 100HP		No Built-in EMI filter
			9000: 90kW, 125HP		
			11000: 110kW, 150HP		
			13200: 132.0kW, 175HP		
			16000: 160.0kW, 215HP		

Selection Guide

Voltage Rating	AC Supply Phase	Motor Rating	Ordering Code					
			Size 1	Size 2	Size 3	Size 4	Size 5	Size 6
380 - 480VAC (+10% to 15%)	3-Phase	3.7kW, 5.0HP	RVFFA3400400F	-	-	-	-	-
		5.5kW, 7.5HP	RVFFA3400550F	-	-	-	-	-
		7.5kW, 10HP	RVFFA3400750F	-	-	-	-	-
		11.0kW, 15HP	-	RVFFB3401100F	-	-	-	-
		15.0kW, 20HP	-	RVFFB3401500F	-	-	-	-
		18.5kW, 25HP	-	-	RVFFC3401850F	-	-	-
		22.0kW, 30HP	-	-	RVFFC3402200F	-	-	-
		30.0kW, 40HP	-	-	RVFFC3403000F	-	-	-
		37.0kW, 50HP	-	-	-	RVFFD3403700F	-	-
		45.0kW, 60HP	-	-	-	RVFFD3404500F	-	-
		55.0kW, 75HP	-	-	-	RVFFD3405500F	-	-
		75kW, 100HP	-	-	-	-	RVFFE3407500	-
		90kW, 125HP	-	-	-	-	RVFFE3409000	-
		110kW, 150HP	-	-	-	-	-	RVFFF34011000
		132kW, 175HP	-	-	-	-	-	RVFFF34013200
		160kW, 215HP	-	-	-	-	-	RVFFF34016000

Input / Output Data

Model: RVFF	RVFFA3400400F	RVFFA3400550F	RVFFA3400750F	RVFFB3401100F
Nominal motor power	3.7kW	5.5kW	7.5kW	11.0kW
Horsepower rating	5HP	7.5HP	10.0HP	15.0HP
Input current	9.6A	11.6A	18.2A	24A
Rated output current	9.2A	12.1A	17.5A	23A
Rated capacity	7kVA	8.4kVA	13kVA	18kVA
AC supply voltage and frequency	3-phase; 380V÷480V, +10% to 15%; 50/60Hz, ± 5%			
Output voltage and frequency	3-phase; 380÷480V; 0.1÷400Hz			

Model: RVFF	RVFFB3401500F	RVFFC3401850F	RVFFC3402200F	RVFFC3403000F
Nominal motor power	15.0kW	18.5kW	22.0kW	30.0kW
Horsepower rating	20.0HP	25.0HP	30.0HP	40.0HP
Input current	32.3A	41.3A	47.8A	58.7A
Rated output current	31.0A	38.0A	44.0A	54.0A
Rated capacity	24.0kVA	29.0kVA	34.0kVA	41.0kVA
AC supply voltage and frequency	3-phase; 380V÷480V, +10% to 15%; 50/60Hz, ± 5%			
Output voltage and frequency	3-phase; 380÷480V; 0.1÷400Hz			



Input / Output Data

Model: RVFF	RVFFD3403700F	RVFFD3404500F	RVFFD3405500F	RVFFE3407500
Nominal motor power	37.0kW	45.0kW	55.0kW	75.0kW
Horsepower rating	50.0HP	60.0HP	75.0HP	100HP
Input current	75.0A	95.7.0A	112.0A	141.0A
Rated output current	73.0A	88.0A	103.0A	145.0A
Rated capacity	55.0kVA	67.0kVA	78.0kVA	110.0kVA
AC supply voltage and frequency	3-phase; 380V÷480V, +10% to 15%; 50/60Hz, ± 5%			
Output voltage and frequency	3-phase; 380÷480V; 0.1÷400Hz			

Model: RVFF	RVFFE3409000	RVFFF34011000	RVFFF34013200	RVFFF34016000
Nominal motor power	90.0KW	110.0KW	132.0KW	160.0KW
Horsepower rating	125.0HP	150.0HP	175.0HP	215.0HP
Input current	181.0A	229.0A	275.0A	325.0A
Rated output current	168.0A	208.0A	250.0A	296.0A
Rated capacity	125.0kVA	158.0kVA	190.0kVA	225.0kVA
AC supply voltage and frequency	3-phase; 380V÷480V, +10% to 15%; 50/60Hz, ± 5%			
Output voltage and frequency	3-phase; 380÷480V; 0.1÷400Hz			

Environmental Data

Installation Location	Indoor (protected from corrosive gases and dust).	Storage Temperature	-20~+70°C (-4°F~+158°F).
Ambient Temperature	-10~+40°C (14°F~104°F) (IP20/NEMA1NEMA12), -10~+50°C (14°F~122°F) (IP00) without derating; with derating, it's max operational temperature is 60°C (140°F).	Humidity	95% RH or less (no condensation).
		Altitude	Altitude of 1000m (3181ft) or below, below 5.9m/s ² (0.6G).
		Vibration	1.0G, in compliance with IEC 60028-2-6.

General Data

<p>Control Characteristics</p> <p>Operation modes</p> <p>Control modes</p> <p>Frequency control range</p> <p>Frequency accuracy (Temperature change)</p> <p>Speed control accuracy</p> <p>Frequency setting resolution</p> <p>Output frequency resolution</p> <p>Inverter overload</p> <p>Frequency setting signal</p> <p>Acceleration/ Deceleration time</p> <p>Voltage, frequency Characteristics</p> <p>Braking torque</p> <p>Main control functions</p>	<p>LED keypad with seven-segment display and LCD keypad (Optional HOA LCD keypad); LCD keypad with parameter copy function.</p> <p>V/F, SLV, PMSLV with space vector PWM mode.</p> <p>0.1Hz~400.0Hz.</p> <p>Digital references: $\pm 0.01\%$ (-10 to +40°C), analog references: $\pm 0.1\%$ (25°C$\pm 10^\circ\text{C}$).</p> <p>$\pm 0.5\%$ (Sensorless vector control mode)</p> <p>Digital references: 0.01Hz, analog references: 0.06Hz/60Hz.</p> <p>0.01Hz.</p> <p>120%/1 min.</p> <p>DC 0~+10V/0~20mA or 4~20mA.</p> <p>0.0~6000.0 seconds (separately set acceleration and deceleration time).</p> <p>Custom V/F curve based on parameters.</p> <p>About 20%</p> <p>Auto tuning, soft-PWM, over voltage protection, dynamic braking, speed search, restart upon momentary power loss, 2 sets of PID control, slip compensation, RS-485 communication standard, simple PLC function, 2 sets of analog outputs, safety switch.</p>	<p>Protection Functions</p> <p>Stall prevention</p> <p>Instantaneous over current (OC) and output short-circuit (SC) protection</p> <p>Inverter overload protection (OL2)</p> <p>Motor overload protection (OL1)</p> <p>Over voltage (OV) protection</p> <p>Under voltage (UV) protection</p> <p>Auto-Restart after momentary power loss</p> <p>Overheat (OH) protection</p> <p>Ground fault (GF) protection</p> <p>DC bus charge indicator</p> <p>Output phase loss (OPL) protection</p>	<p>Current level can be set separately in acceleration or constant speed; it can be set with or without protection in deceleration.</p> <p>Inverter stops when the output current exceeds 160% of the inverter rated current.</p> <p>If inverter rated current 120%/1min is exceeded, the inverter stops. The factory default carrier frequency is 2~4KHZ*2.</p> <p>Electrical overload protection curve.</p> <p>If the main circuit DC voltage rises over 820V (400V class), the motor stops running.</p> <p>Under voltage (UV) protection. If the main circuit DC voltage falls below 380V (400V class), the motor stops running.</p> <p>If the power loss exceeds 15ms, auto-restart function available after momentary power loss in 2 sec.</p> <p>Temperature sensor for protection.</p> <p>Current sensor for protection.</p> <p>When main circuit DC voltage $\geq 50\text{V}$, the charge LED turns on.</p> <p>If OPL is detected, the motor stops automatically.</p>
<p>Other Functions</p>	<p>Accumulated power-on/run time, 4 sets of fault history records and latest fault record state, energy-saving function setting, phase loss protection, smart braking, DC braking, S curve acceleration and deceleration, up/down operation, modbus, BACnet MS/TP and metasys N2 communication protocol, display of multi-engineering unit, local/remote switch, sink/source input interface selection, user parameter settings.</p>	<p>Communication Function</p> <p>PLC Function</p> <p>EMI Protection</p> <p>EMS Protection</p> <p>Safety Certification</p> <p>CE declaration</p> <p>UL certification</p> <p>Accessories</p>	<p>Built-in RS-485 as standard (Modbus protocol with RJ45/BACnet/Metasys N2).</p> <p>Built-in.</p> <p>The built-in noise filter complies with EN61800-3 available for inverters 400V 75HP or below (IP20)/400V 60HP or below (IP55).</p> <p>In compliance with EN61800-3.</p> <p>In compliance with EN61800-3 (CE & RE) and EN61800-5-1 (LVD, Low-Voltage directive). UL508C.</p> <p>1 to 8 pump card, HOA LCD keypad, profibus card.</p>

Connection Diagrams

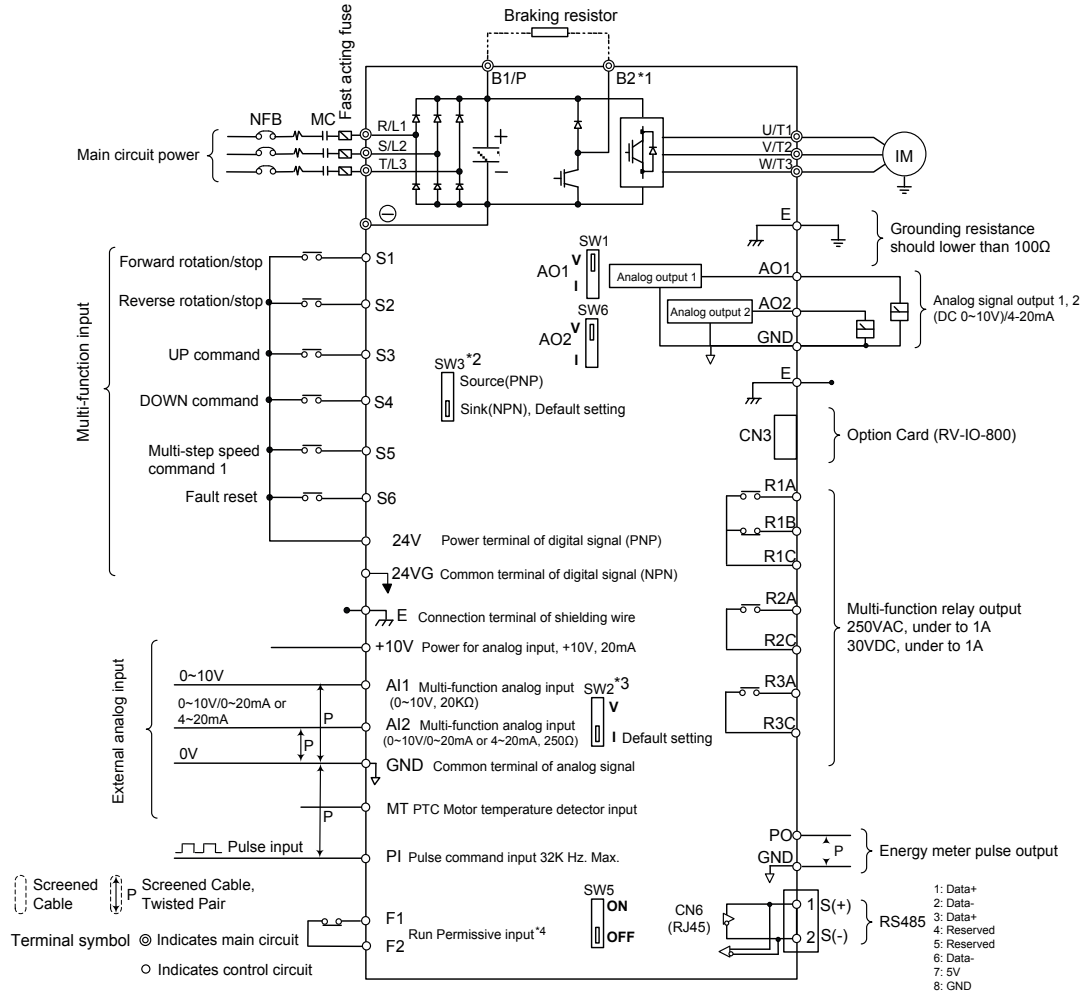

Notes:

- *1: Models IP20 400V 5~40HP have a built in braking resistor, which can be connected between terminal B1 and B2.
- *2: The multi-function digital input terminals S1~S6 can be set on source (PNP) or sink (NPN) mode via SW3.
- *3: The multi-function analog input 2 (AI2) can be set to the voltage command input (0~10V) or the current command input (4~20mA) via SW2.
- *4: Safety inputs F1 and F2 are normally closed inputs. The inputs should be closed to enable the inverter output. To activate these inputs, open the link between F1 and F2.

Description of Control Circuit Terminals

Type	Terminal	Terminal function	Signal level information
Digital input signal	S1	Forward rotation stop command (default), multi-function input terminals*	Signal level 24VDC (opto-isolated) Max. current: 8mA Max. voltage: 30VDC Input impedance: 4.22Ω
	S2	Reversal rotation stop command (default), multi-function input terminals*	
	S3	UP command (default), multi-function input terminals*	
	S4	DOWN command (default), multi-function input terminals*	
	S5	Multi-step speed frequency command 1, multi-function input terminals*	
	S6	Fault reset input, multi-function	
24V Power supply	24V	Digital signal source point (SW3 switched to source)	±15%
	24VG	Common terminal of digital signals common point of digital signal SINK (SW3 switched to SINK)	Max. output current: 250mA (the sum of all loads connected)
Analog input signal	+10V	Power for external speed potentiometer	±5% (Max. current: 20mA)
	MT	Motor temperature detector of externally connecting PTC	1330Ω movement, 550Ω return
	AI1	Multi-function analog input for speed reference (0~10V input)	From 0 to +10V Input impedance: 20Ω Resolution: 12bit
	AI2	Multi-functional analog input terminals *2, can use SW2 to switch voltage or current input (0~10V / 4~20mA output)	From 0 to +10V Input impedance: 20Ω From 4 to 20mA Input impedance: 250Ω Resolution: 12 bit
	GND	Analog signal ground terminal	---
	E	Shielding wire connecting terminal (Ground)	---
Pulse output signal	AO1	Multi-function analog output terminals *3 (0~10V / 4~20mA output)	From 0 to 10V Max. current: 2mA From 4 to 20mA
	AO2	Multi-function analog output terminals *3 (0~10V / 4~20mA output)	
	GND	Analog signal ground terminal	---
Pulse input signal	PO	Pulse output, band width 32KHz	Max. Frequency: 32KHz Open collector output
	GND	Analog signal ground terminal	---
	PI	Pulse command input, frequency width of 32KHz	L: from 0.0 to 0.5V H: from 4.0 to 13.2 Max. Frequency: 0 - 32KHz Impedance: 3.89Ω
	GND	Analog signal ground terminal	---

Terminal Description

IP55 Type
 400V: 5-10HP

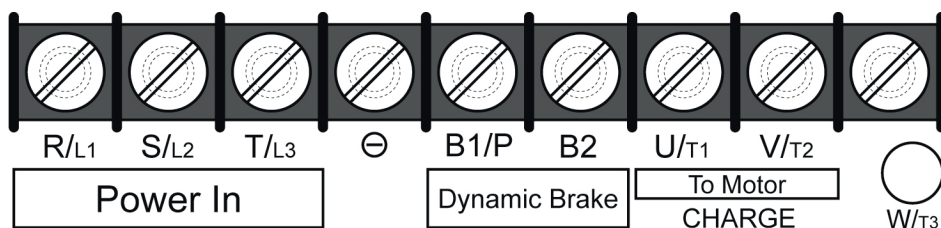

Terminal screw size	
T	
M4	M4

400V: 15-20HP

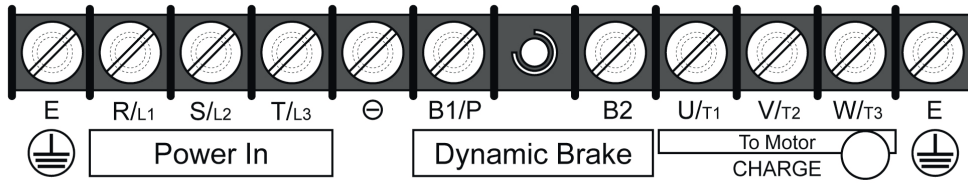

Terminal screw size	
T	
M4	M4

400V: 25-40HP

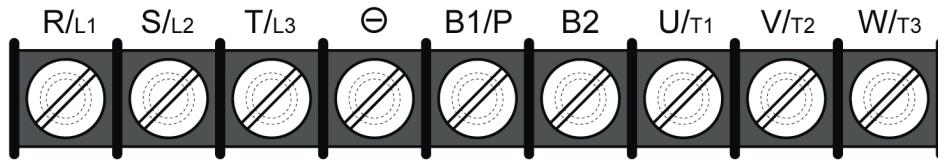

Terminal screw size	
T	
M6	M6

400V: 50-75HP

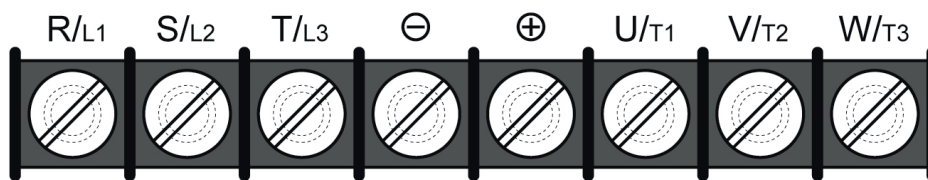

Terminal screw size	
T	
M8	M8

400V: 100-125HP

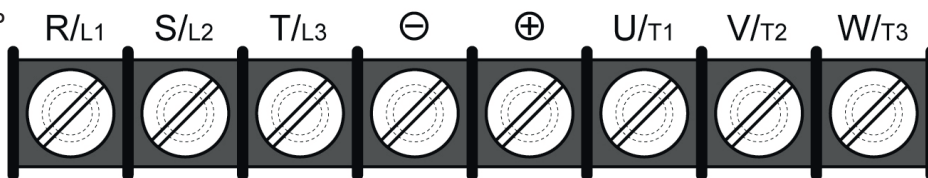

Terminal screw size		
Power supply	T	
400V 100HP	M8	M10
200V 60-75HP 400V 125HP	M10	M10

400V: 150-215HP

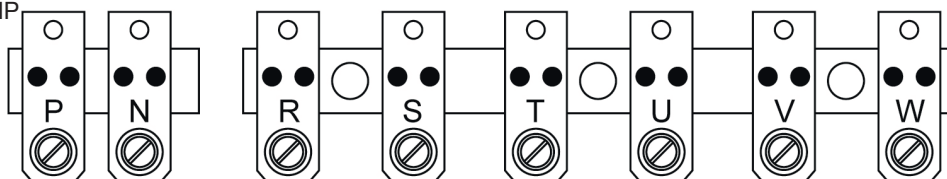

Terminal screw size	
T	
M10	M10

Wiring for Main Circuit Terminals (IP20 Type)

Description of main circuit terminals (IP20 Type)

Terminal	400V : 5~40HP	400V : 50~215HP
R/L1	Input Power Supply	
S/L2		
T/L3		
B1/P	<ul style="list-style-type: none"> • B1/P- ⊖ : DC power supply • B1/P-B2: external braking resistor 	-
B2		
⊖	-	<ul style="list-style-type: none"> • ⊕ - ⊖ : DC power supply or connect braking module
⊕		
U/T1	Inverter output	
V/T2		
W/T3		
E	Ground terminal	

Dimensions (mm/inches)

400V : 5-10HP

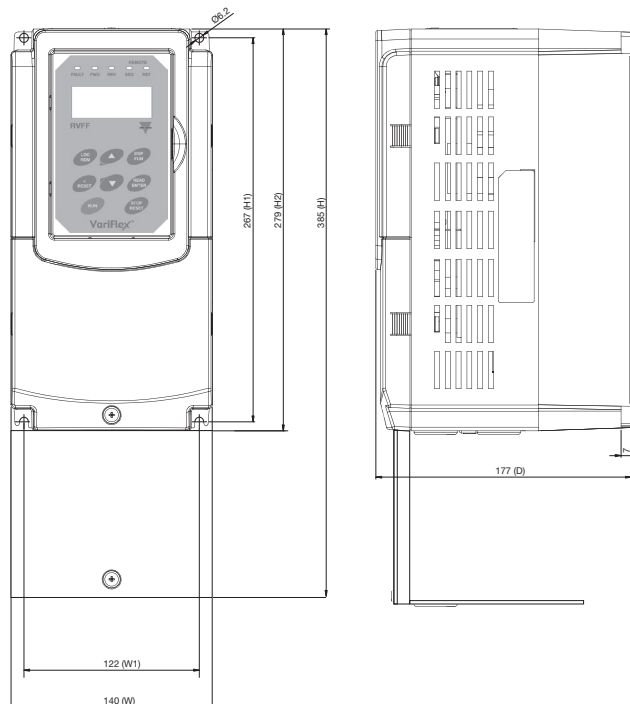

Model	W	H	D	W1	H1	H2	t	d	Weight kg (lbs)
RVFFA3400400F	140 (5.51)	385 (15.16)	177 (6.97)	122 (4.80)	267 (10.51)	279 (10.98)	7 (0.28)	M6	5.5 (12.13)
RVFFA3400550F	140 (5.51)	385 (15.16)	177 (6.97)	122 (4.80)	267 (10.51)	279 (10.98)	7 (0.28)	M6	5.5 (12.13)
RVFFA3400750F	140 (5.51)	385 (15.16)	177 (6.97)	122 (4.80)	267 (10.51)	279 (10.98)	7 (0.28)	M6	5.5 (12.13)

Dimensions (mm/inches)

400V : 15-20HP

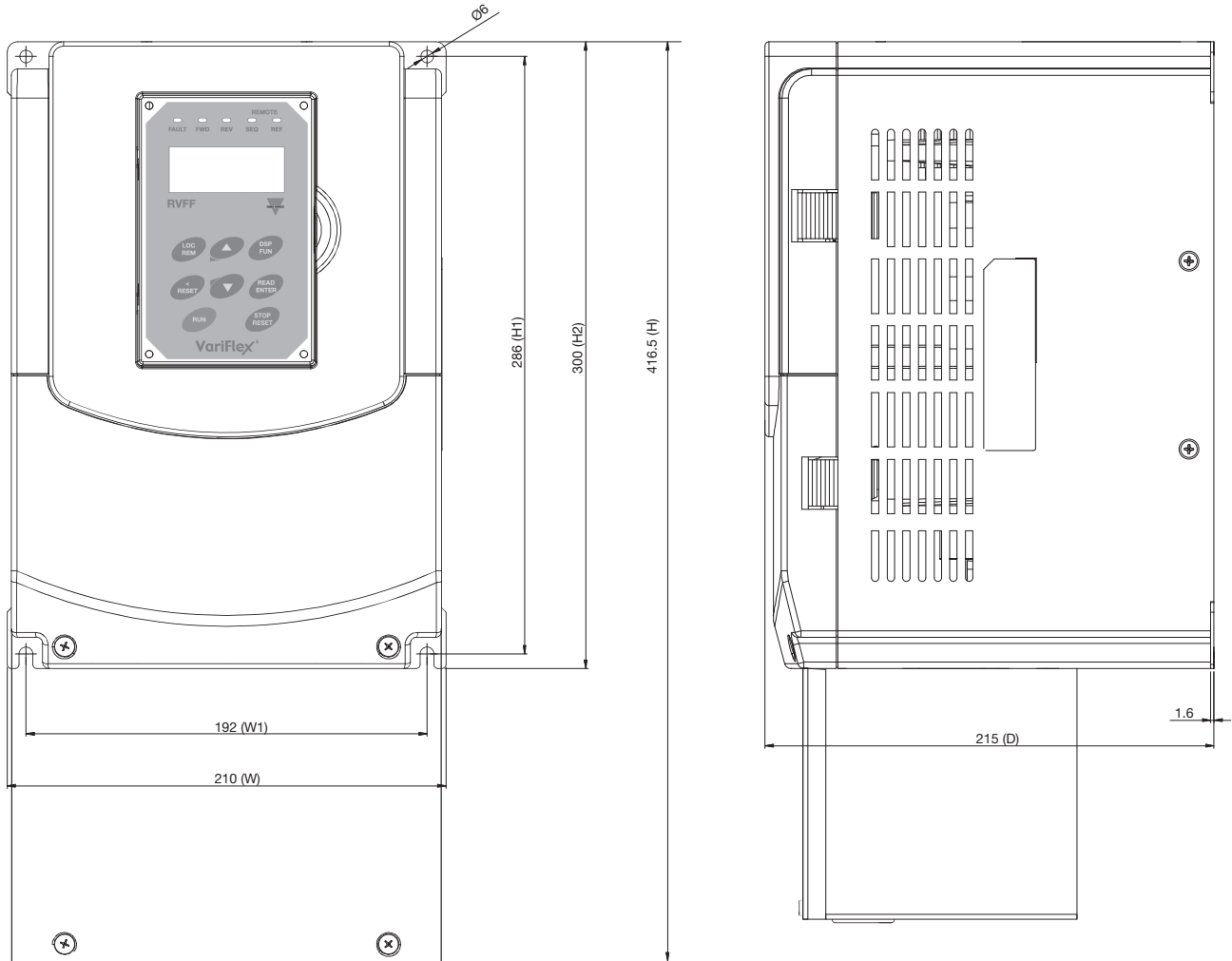

Model	W	H	D	W1	H1	H2	t	d	Weight kg (lbs)
RVFFB3401100F	210 (8.27)	416.5 (16.40)	215 (8.46)	192 (7.56)	286 (11.26)	300 (11.81)	1.6 (0.06)	M6	8.0 (17.64)
RVFFB3401500F	210 (8.27)	416.5 (16.40)	215 (8.46)	197 (7.56)	286 (11.26)	300 (11.81)	1.6 (0.06)	M6	8.0 (17.64)

Dimensions (mm/inches)

400V : 20-40HP

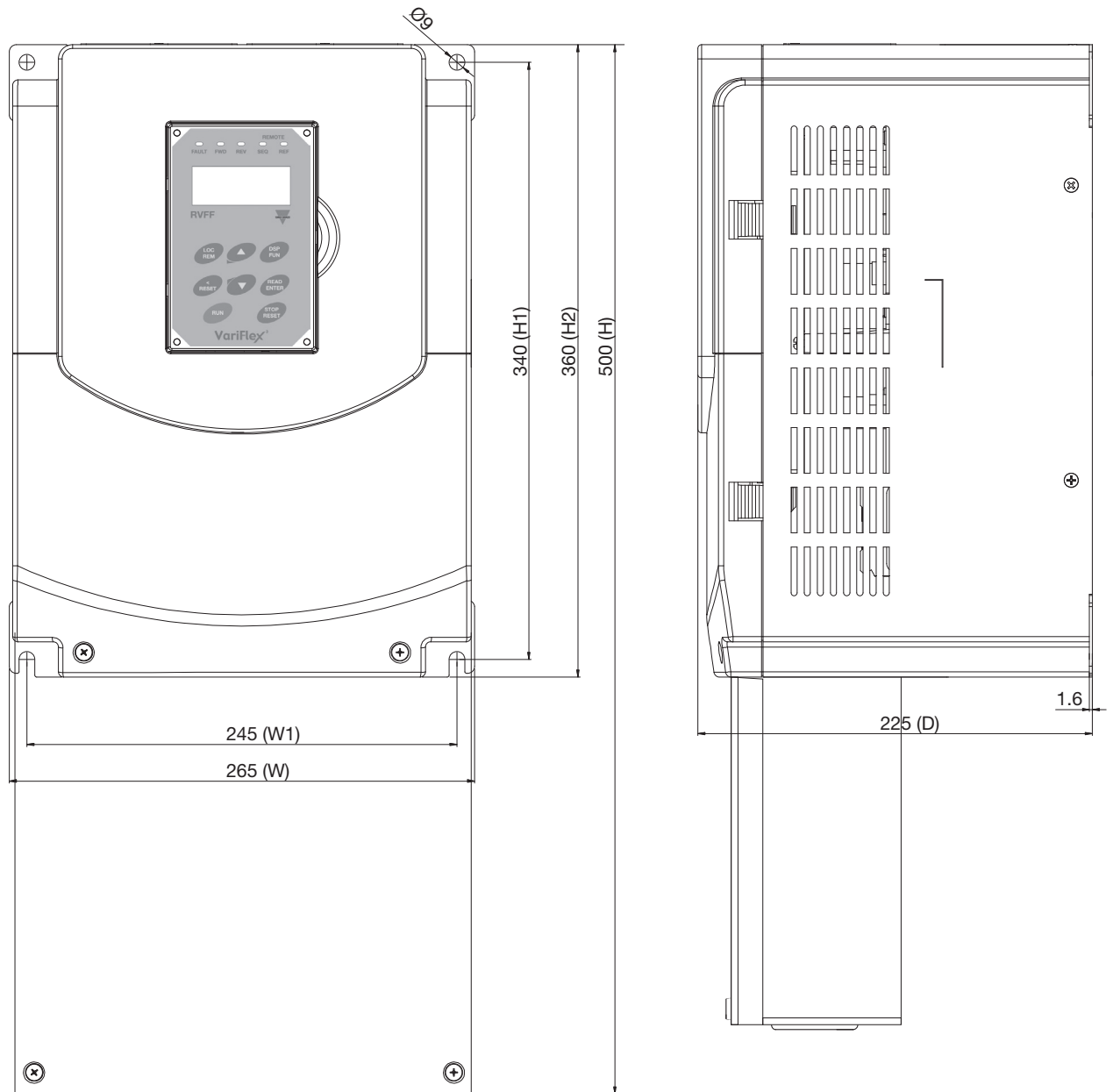

Model	W	H	D	W1	H1	H2	t	d	Weight kg (lbs)
RVFFC3401850F	265 (10.43)	500 (19.69)	225 (8.86)	245 (9.65)	340 (13.39)	360 (14.17)	1.6 (0.06)	M8	12.5 (27.56)
RVFFC3402200F	26 (10.43)	500 (19.69)	225 (8.86)	245 (9.65)	340 (13.39)	360 (14.17)	1.6 (0.06)	M8	12.5 (27.56)
RVFFC3403000F	265 (10.43)	500 (19.69)	225 (8.86)	245 (9.65)	340 (13.39)	360 (14.17)	1.6 (0.06)	M8	12.5 (27.56)

Dimensions (mm/inches)

400V : 50-75HP

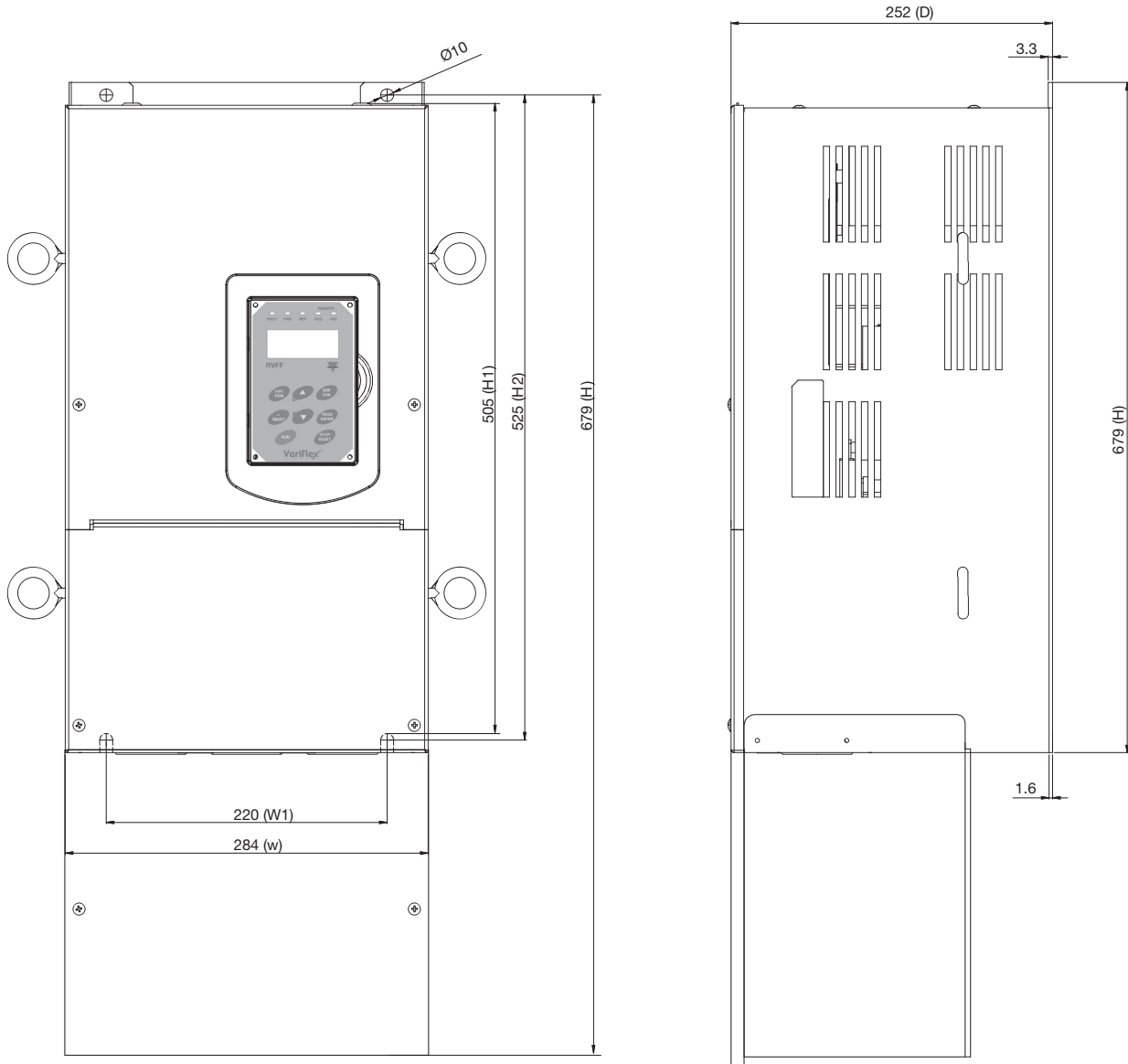

Model	W	H	D	W1	H1	H2	t	d	Weight kg (lbs)
RVFFD3403700F	284 (11.18)	679 (26.73)	252 (9.92)	220 (8.66)	505 (19.88)	525 (20.67)	1.6 (0.06)	M8	32.5 (71.65)
RVFFD3404500F	284 (11.18)	679 (26.73)	252 (9.92)	220 (8.66)	505 (19.88)	525 (20.67)	1.6 (0.06)	M8	32.5 (71.65)
RVFFD3405500F	284 (11.18)	679 (26.73)	252 (9.92)	220 (8.66)	505 (19.88)	525 (20.67)	1.6 (0.06)	M8	32.5 (71.65)

Dimensions (mm/inches)

400V : 100-215HP

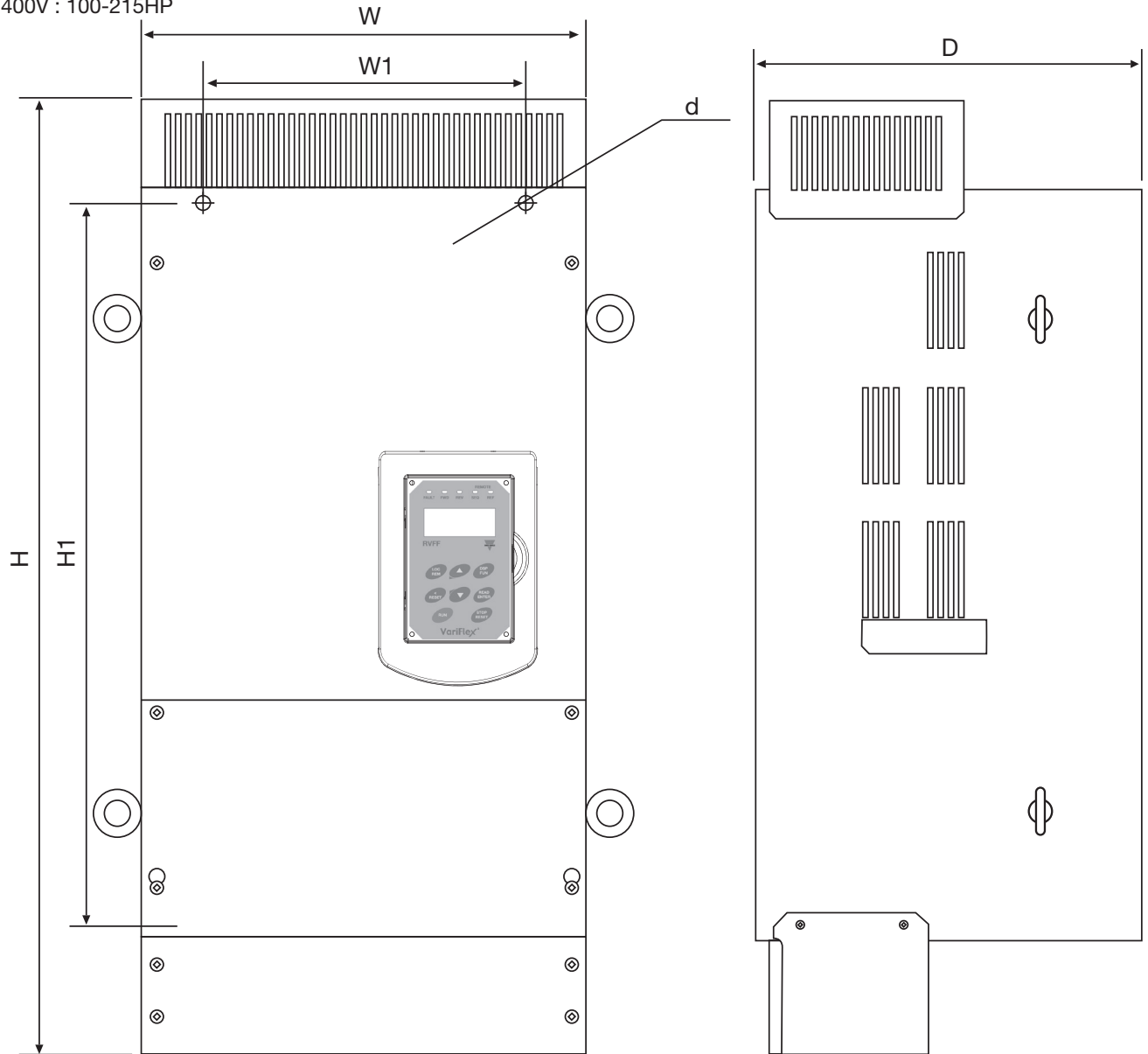

Model	W	H	D	W1	H1	t	d	Weight kg (lbs)
RVFFE3407500	348.5 (13.72)	740 (29.13)	300 (11.81)	250 (9.84)	560 (22.05)	1.6 (0.06)	M10	44 (97.00)
RVFFE3409000	348.5 (13.72)	740 (29.13)	300 (11.81)	250 (9.84)	560 (22.05)	1.6 (0.06)	M10	44 (97.00)
RVFFF34011000	463.5 (18.25)	1105 (43.50)	324.5 (12.78)	320 (12.60)	760 (29.92)	1.6 (0.06)	M10	81 (178.57)
RVFFF34013200	463.5 (18.25)	1105 (43.50)	324.5 (12.78)	320 (12.60)	760 (29.92)	1.6 (0.06)	M10	81 (178.57)
RVFFF34016000	463.5 (18.25)	1105 (43.50)	324.5 (12.78)	320 (12.60)	760 (29.92)	1.6 (0.06)	M10	81 (178.57)

Installation Space

Sufficient air circulation space for cooling should be provided, as shown in examples below.
(We recommend that the drive is installed on a dissipative surface).

Single unit installation

In order to ensure optimal cooling the transducer should be installed vertically.

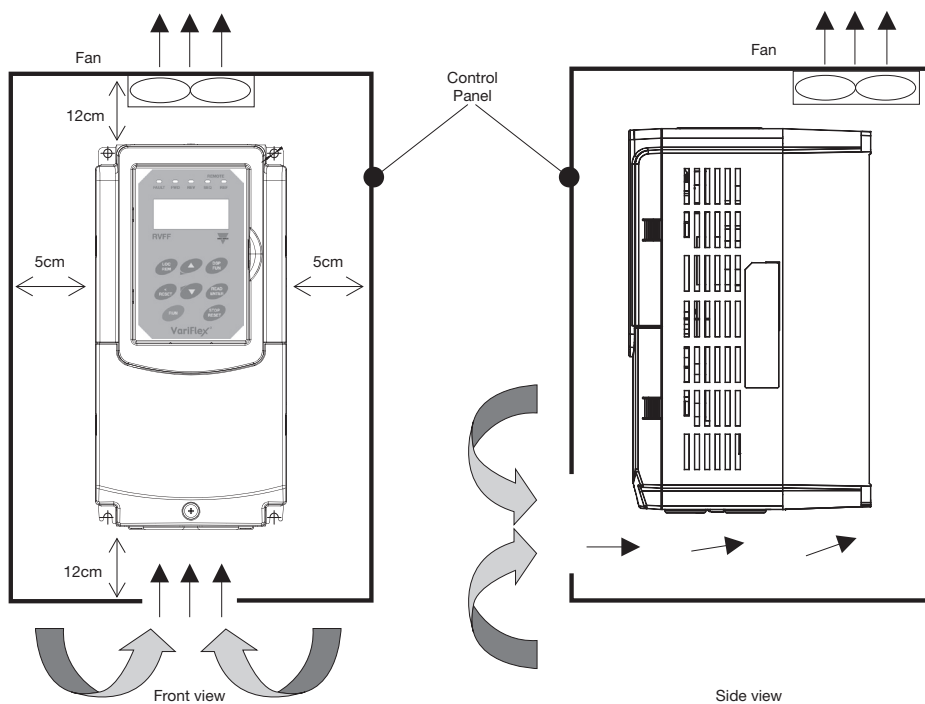

Side by side installation

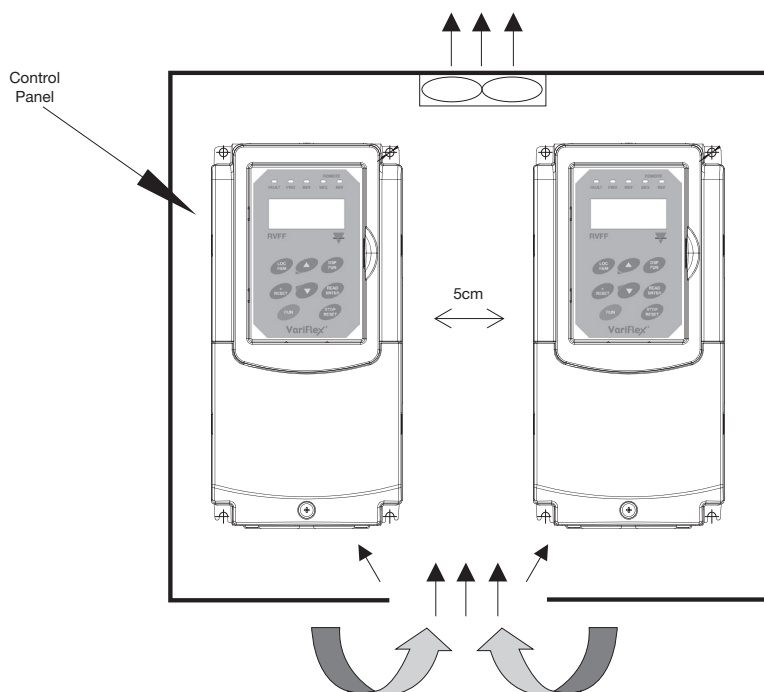

The necessary physical space and cooling should be provided, based on the ambient temperature and the heat loss in the panel.

Environment

Installation site

Install in an environment that will not have an adverse effect on the operation of the unit and ensure that there is no exposure to the following:

- Direct sunlight, rain or moisture.
- Oil, mist or salt.
- Dust, lint fibres, small metal filings or corrosive liquids or gas.
- Electromagnetic interference from sources such as welding equipment.
- Radioactive or flammable materials.
- Excessive vibration from machines such as stamping or punching machines.
(Add vibration-proof pads if necessary).