

Q16 series

Ø16 mm panel mount LED indicators



DISTINCTIVE FEATURES

Secret until lit polycarbonate decals or custom engraving
 10 mm colored diffused epoxy lens or 10 mm water clear super bright LEDs
 (2.8 x 0.8) solder lug/faston terminals, pins or (200 mm long) wire terminations
 Available in RGB



ENVIRONMENTAL SPECIFICATIONS

- IP67 sealing option (EN60529)
- Operating & Storage Temperature Range:
Rear plastic body: -30 °C to +65 °C (-22 °F to +149 °F)
Rear epoxy body: -40 °C to +85 °C (-40 °F to +185 °F)



GENERAL SPECIFICATIONS

- Max Reverse Voltage: 5 V
- Viewing Angle: 30–100° (dependant on model)
- Life Expectancy: 100,000 hours
- Torque: 75 cNm
- Maximum panel thickness 11 mm



MATERIALS

- Plated brass bezel finished in bright chrome, black or satin grey and moulded polycarbonate rear body



MOUNTING

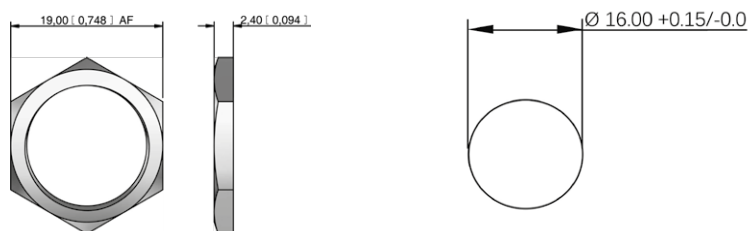

The company reserves the right to change specifications without notice.

All LED characteristics are dependent upon environmental conditions. Therefore published data should be considered nominal and subject to variations.



Q16 series

Ø16 mm panel mount LED indicators



ELECTRICAL SPECIFICATIONS

STANDARD LED INTENSITY

| LED COMPONENT SPECIFICATIONS | | | |
|--|------------------------|--------------|-------------------|
| | Prominent and Recessed | Flush | Forward Voltage |
| HE Red | 80 mcd | 10 mcd | 2.0 V |
| Green | 60 mcd | 5 mcd | 2.2 V |
| Yellow | 50 mcd | 4 mcd | 2.1 V |
| Blue | 540 mcd | 100 mcd | 3.3 V |
| White | 1,000 mcd | 150 mcd | 3.3 V |
| Orange | 80 mcd | 200 mcd | 2.2 V |
| Bi-color (Typical) (Red/Green) | 15/15 mcd | 14/10 mcd | 2.0 V/2.2 V |
| Tri-color (Typical) (Red/Green/Yellow) | 60/50/50 mcd | 15/10/30 mcd | 2.0 V/2.2 V/2.1 V |

Bi-color - The color is changed by reversing the polarity of the supply voltage.
Tri-color - The indicator has red and green LEDs, when both connected yellow is produced.

SUPER BRIGHT LED INTENSITY

| LED COMPONENT SPECIFICATIONS | | | |
|------------------------------|------------------------|----------|-----------------|
| | Prominent and Recessed | Flush | Forward Voltage |
| HE Red | 17,000 mcd | 2000 mcd | 2.2 V |
| Green | 11,000 mcd | 680 mcd | 3.5 V |
| Yellow | 4,000 mcd | 350 mcd | 2.3 V |
| Blue | 2,500 mcd | 250 mcd | 3.3 V |
| White | 4,400 mcd | 250 mcd | 3.3 V |
| Orange | 2,800 mcd | 300 mcd | 2.1 V |

HYPER BRIGHT LED INTENSITY

| LED COMPONENT SPECIFICATIONS | | | |
|------------------------------|------------------------|---------|-----------------|
| | Prominent and Recessed | Flush | Forward Voltage |
| HE Red | 2,800 mcd | 800 mcd | 2.0 V |
| Green | 2,200 mcd | 250 mcd | 3.2 V |
| Yellow | 1,300 mcd | 250 mcd | 2.0 V |
| Orange | 850 mcd | 200 mcd | 2.1 V |

RGB LED INTENSITY

| ITEM | SYMBOL | CONDITION | TYP. |
|--------------------|---------------------|-----------|---------|
| DC Forward Voltage | $V_F(R)$ | IF=20 mA | 2.1 |
| | $V_F(B/G)$ | IF=20 mA | 3.1 |
| Luminous Intensity | $I_v(\text{Red})$ | | 220 mdc |
| | $I_v(\text{Green})$ | | 500 mdc |
| | $I_v(\text{Blue})$ | | 100 mdc |

| Voltage | Operating Voltage | Operating Current |
|------------------|-------------------|---------------------|
| | (Min to Max) | (Typical All Types) |
| 02 (No Resistor) | 1.8 to 3.3 VDC | 20 mA max* |
| 6 VDC | 5.4 to 6.6 VDC | 20 mA |
| 12 VDC | 10.8 to 13.2 VDC | 20 mA |
| 24 VDC | 21.6 to 26.4 VDC | 20 mA |
| 28 VDC | 25.2 to 30.8 VDC | 20 mA |
| 110 VAC | 99 to 121 VAC | 6 mA |
| 220 VAC | 207 to 235 VAC | 3 mA |

* Customer to supply resistor for desired operating current.

ADDITIONAL INFORMATION ON LED COMPONENTS

- Bi-color leds, by connecting the gold faston (+) one color is produced, by reversing the supply voltage another color is produced – bi-colors are available up to 28 VDC
- The tri-color led has red and green leds when both are connected yellow is produced.
- The operating voltage must not be exceeded by more than 10% as this will result in reduced life expectancy
- Luminous intensity is measured at 20 mA on a discrete led unless otherwise stated.
- Luminous intensities and color shades of white LEDs may vary within a batch.
- Luminous intensity will be reduced with lower operating current.



CONNECTIONS

REAR EPOXY WIRES FOR RGB OPTION

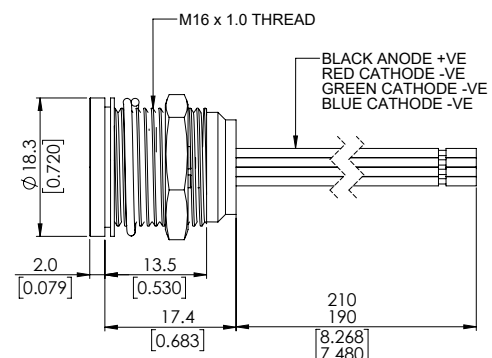

Q16 series

Ø16 mm panel mount LED indicators



BUILD YOUR PART NUMBER

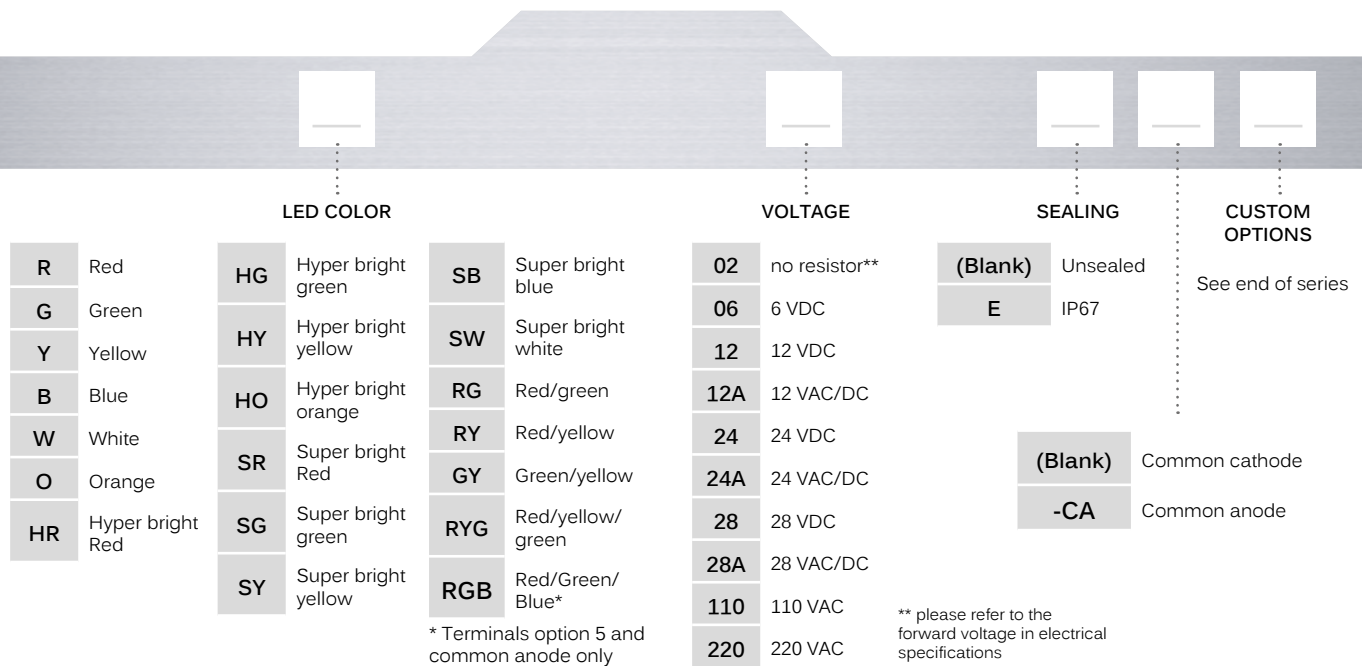
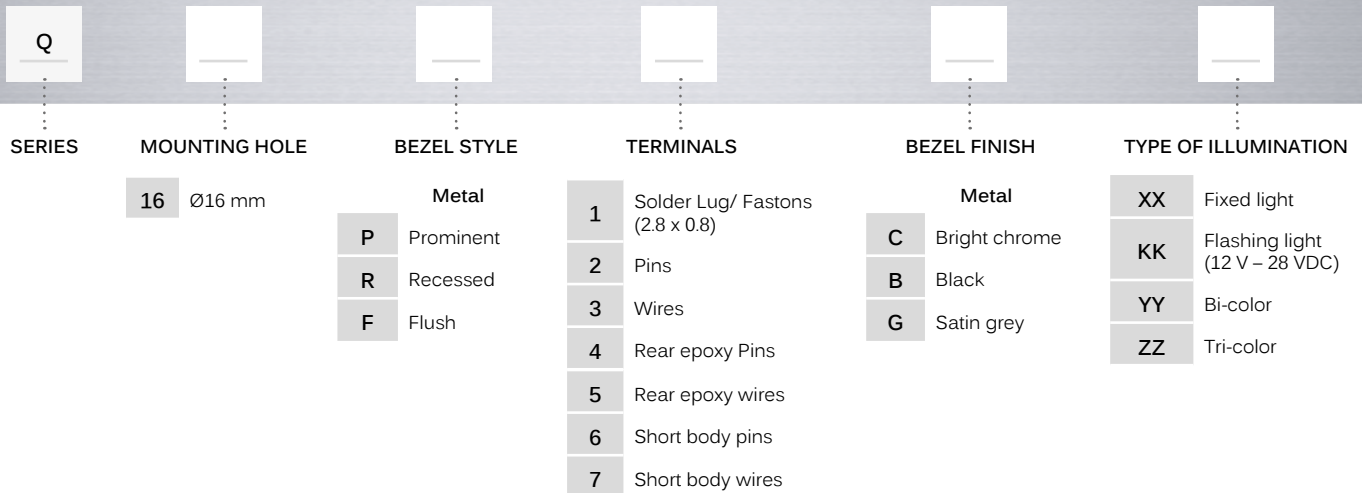

ABOUT THIS SERIES

- Notice:** please note that not all combinations of above numbers are available.
- Gold faston terminal denotes anode (+), silver terminal denotes cathode (-)
 - Standard wire length is 200 mm, 22 AWG UL1007, red wire denotes anode (+), black wire denotes cathode (-) for other wire lengths consult APEM
 - Take care when soldering to the faston terminals (recommended solder temperature 300 °C - 3 sec)
 - Body options 2 and 6 are only available without integral resistor (02).
 - Standard tri-color faston terminals are two anodes (+) and one cathode (-)
 - Tri-color wires are one red (+) and one green (+) anode and one black (-) cathode
 - Tri-color pins are center (-) cathode, shortest (+) anode pin green, longest (+) anode pin red
 - We recommend using hyperbright or superbright leds for use at 110 VAC and 220 VAC
 - For leds with alternative voltages and for multi-voltage options please consult APEM

Q16 series

Ø16 mm panel mount LED indicators

PROMINENT BEZEL



WIRES

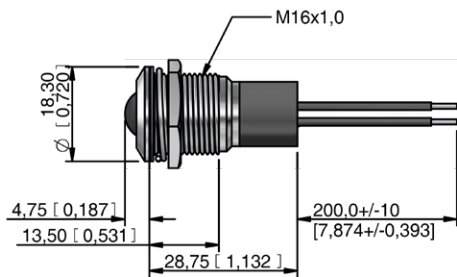

REAR EPOXY WIRES

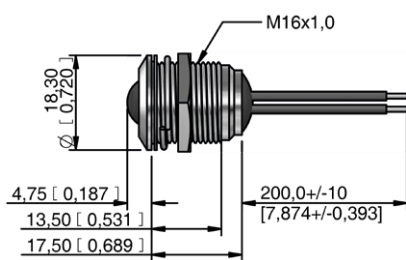

SHORT BODY WIRES

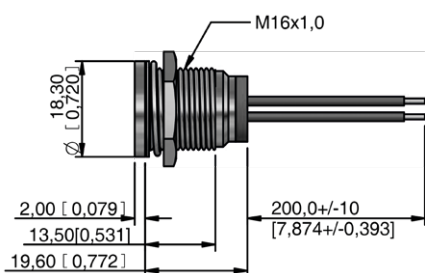

SOLDER LUG/FASTON

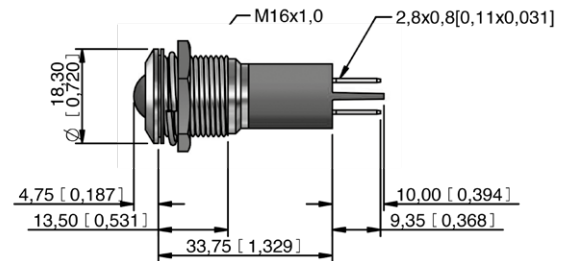

PINS

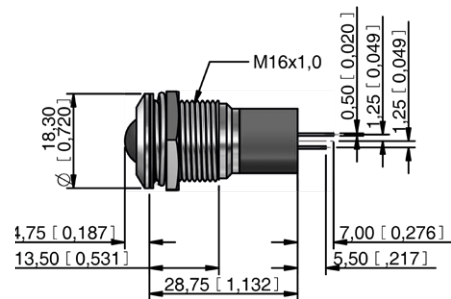

REAR EPOXY PINS

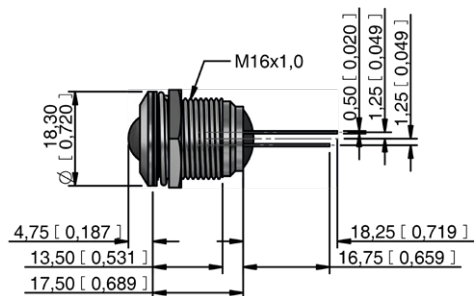

SHORT BODY PINS

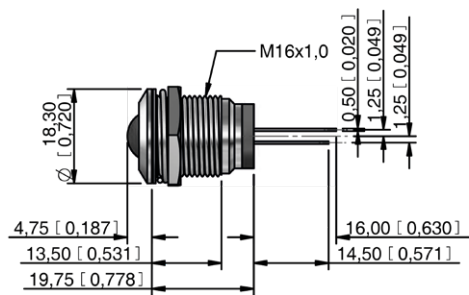

Q16 series

Ø16 mm panel mount LED indicators

FLUSH BEZEL



WIRES

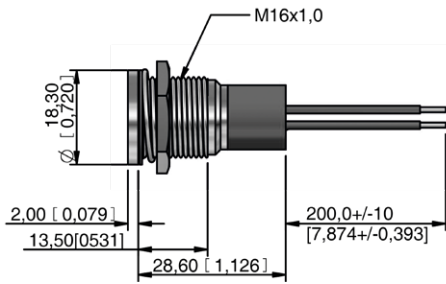

REAR EPOXY WIRES

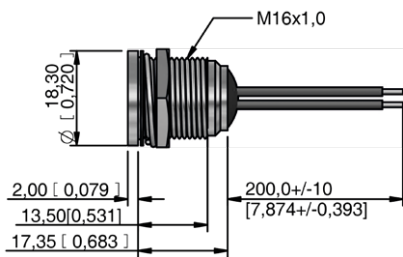

SHORT BODY WIRES

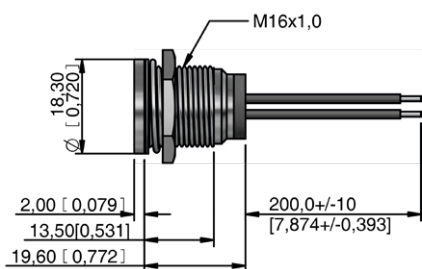

SOLDER LUG/FASTON

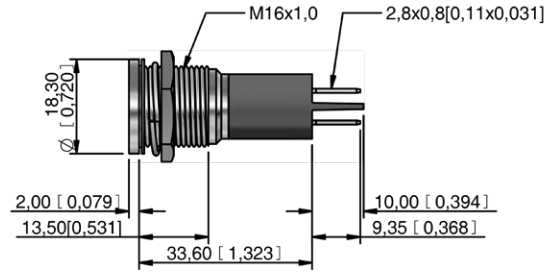

PINS

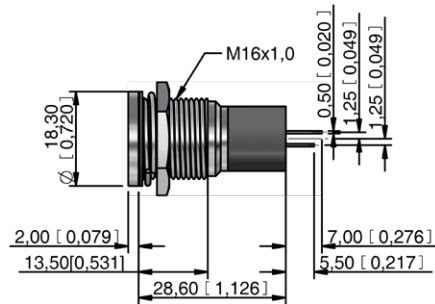

REAR EPOXY PINS

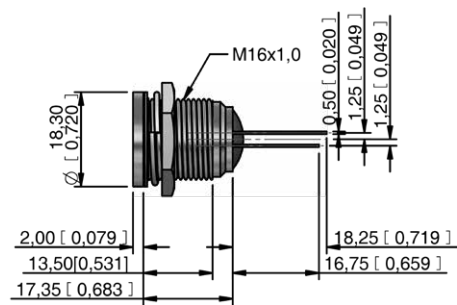

SHORT BODY PINS

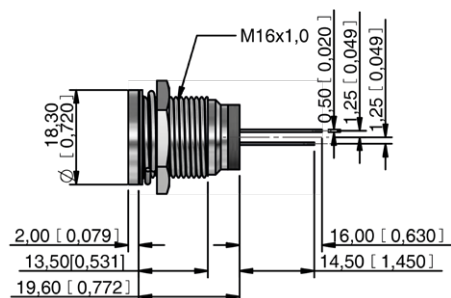

Q16 series

Ø16 mm panel mount LED indicators

RECESSED BEZEL



WIRES

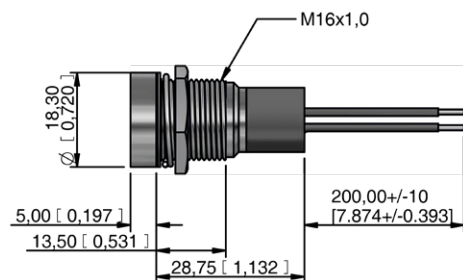

REAR EPOXY WIRES

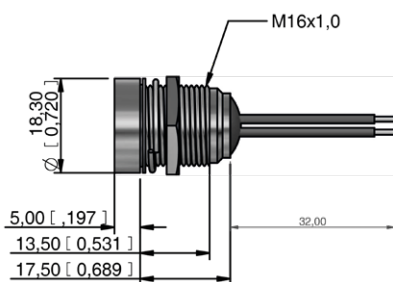

SHORT BODY WIRES

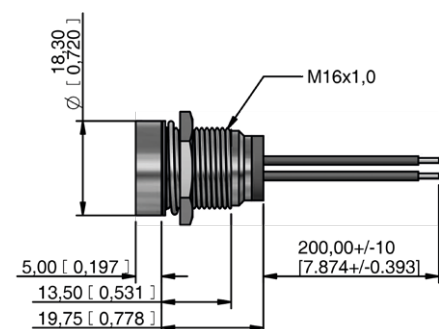

SOLDER LUG/FASTON

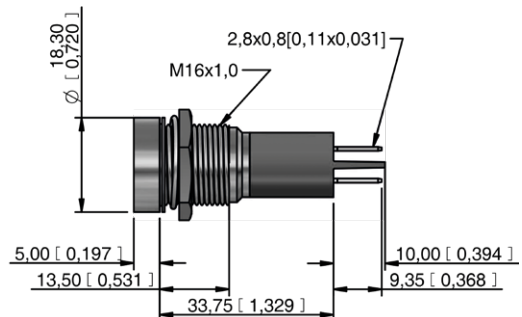

PINS

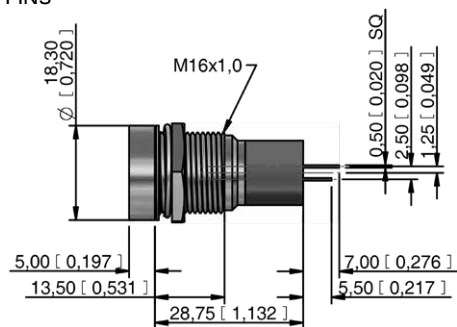

REAR EPOXY PINS

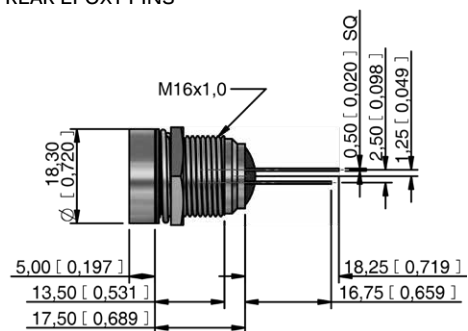



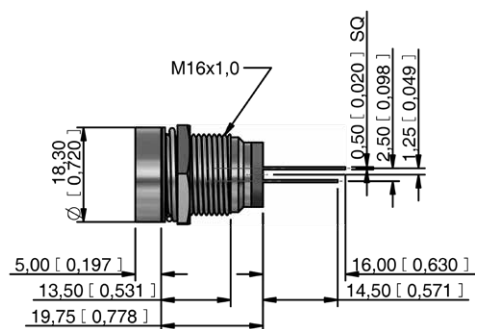























SHORT BODY PINS



CUSTOM ENGRAVING

Some common codes are listed above, for your custom requirements please contact APEM.
Unless specified standard engraving with white infill will be supplied.
Suffix the part number with legend code :

| | | | | | | |
|---|---|---|---|--|---|---|
|  |  |  |  |  |  |  |
| High beam -0AJ | Low beam -097 | Rear fog -027 | Front fog -026 | Windscreen wiper -021 | Windscreen washer -022 | Ventilator fan -023 |
|  |  |  |  |  |  |  |
| Turn Signal -0AH | Side lights -098 | Horn -041 | Hazard warning -013 | Heating -018 | Brake test -0BU | Arrow -0K6 |
|  |  |  |  |  |  |  |
| Battery -0AG | Oil can -0GP | Windscreen heating -020 | ABS -086 | Engine coil -0EL | Seat belt -0SB | USB connection -0UB |
|  |  |  |  |  |  | |
| Steam -0ST | ECU -0EU | Side step -0AD | Air con -012 | Engine -040 | Boot/Trunk Release -0BR | |



Q16 series

Ø16 mm panel mount LED indicators



SECRET UNTIL LIT POLYCARBONATE INSERTS

Some common codes are listed above, for your custom requirements please contact APEM. Please note Secret until lit inserts only available with flush metal bezel (Option F)
Suffix the part number with legend code :



CABLE LENGTH AND CONNECTOR



For custom cable length and connectors contact APEM.