

R13 Round Rocker Switches 10A 250Vac



- ▶ Miniature round rocker switch
- ▶ Ratings up to 10A, 250Vac
- ▶ Single & double pole
- ▶ Illuminated & non-illuminated, neon and LED
- ▶ Choice of actuators
- ▶ Matching indicator
- ▶ Panel cut out: 20.2 dia.



SP 6A 250Vac T85,
DP 10(4)A 250Vac T85



UL CSA SP 10A 125Vac & 6A 250Vac (For 16A call the factory)
UL CSA DP 8A 125/250Vac
UL 85°C, file E67774(S)
CSA file LR45128



RoHS compliant

Single pole has μ contact gap.
Technical data on pages 4 & 5.

Standard products

Are supplied with the body and rocker color, print & lamp voltage shown in the product illustration and description.

PRODUCT DETAILS



SP ON - OFF μ

Cat no.
R13 112ABB-602AW

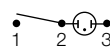

SP ON - OFF μ
Lit 110V

Cat no.
R13 112BWR2



SP ON - OFF μ

Cat no.
R13 112AWW-602AB

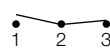

SP ON - ON μ

Cat no.
R13 112CBB

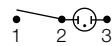

SP ON - OFF μ
Lit 110V

Cat no.
R13 112BBR2

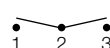

SP ON - OFF - ON μ

Cat no.
R13 112DBB-730W

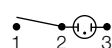

SP ON - OFF μ
Lit 110V

Cat no.
R13 112BBG2



SP ON - OFF μ
(Momentary On)*

Cat no.
R13 208FBB



DP ON - OFF
Lit 110V

Cat no.
R13 244ABB-602AW



DP ON - OFF
Lit 110V

Cat no.
R13 244BBR2

DIMENSIONS (mm)

Panel cut-out

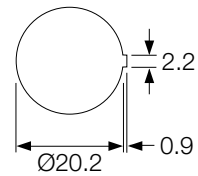

Snap fixing into panel thickness up to 3.0

Single pole

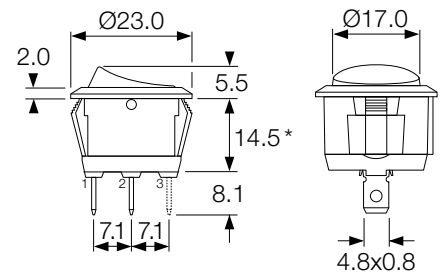

* R13 208F has 12.5mm deep body

Double pole

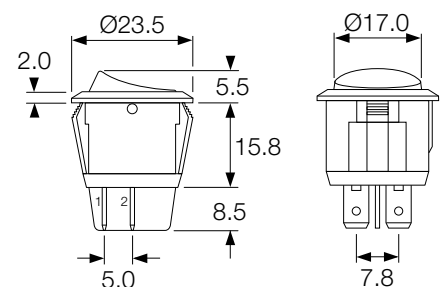

ORDER FORMAT



R13 112B



R13 112A



R13 112A2 ---

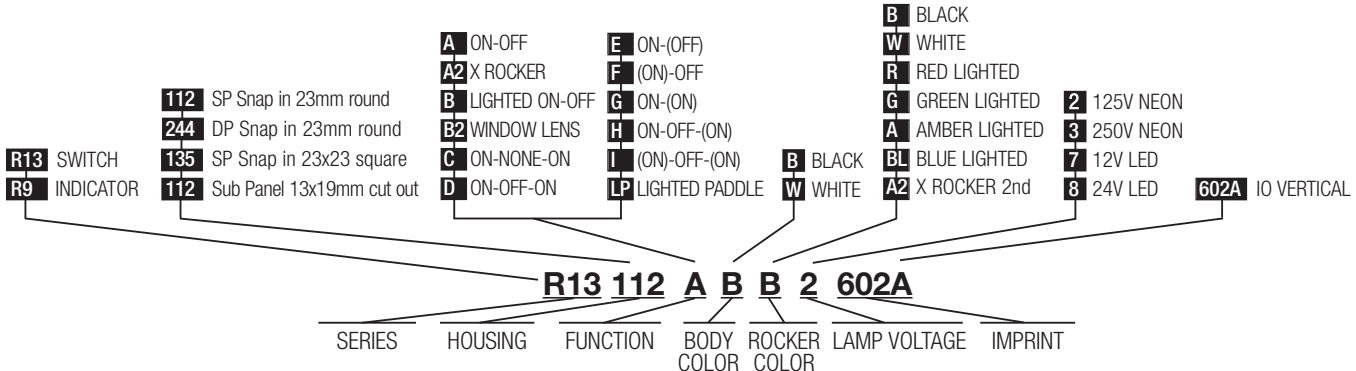

PRODUCT DETAILS

	<p>SP ON - OFF μ Bright colour ON signal Cat no. R13 112A2BBR</p>
	<p>SP ON - OFF μ Lit Window 110V Cat no. R13 112B2BR2</p>
	<p>SP ON - OFF μ Paddle tip has red LED Cat no. R13 112LPBBR</p>
	<p>Indicator light 110V Cat no. R9 92B BR2</p>

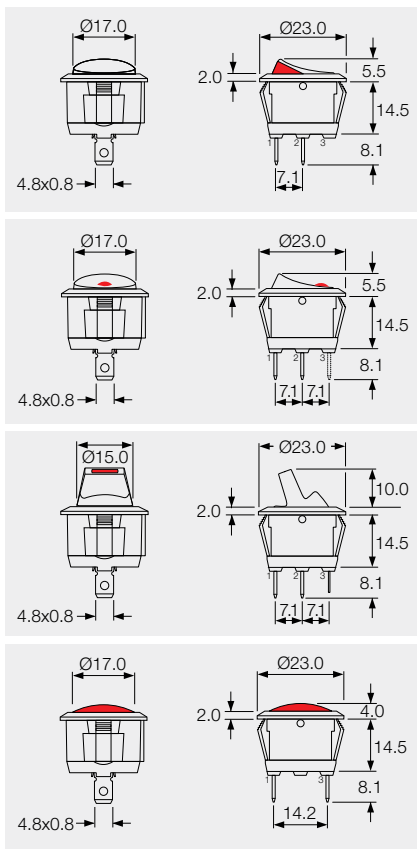

PANEL CUT-OUT (mm)

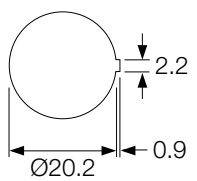

Snap fixing into panel thickness up to 3.0



Protective cover L188

Snaps on to bodies (not R13 211 or R13 112LP), this reduces maximum acceptable panel thickness to 2.4mm.

approvals - contact sales