

D-SERIES DRM

DRM270024

Weidmüller Interface GmbH & Co. KG
 Klingenbergstraße 26
 D-32758 Detmold
 Germany
 Fon: +49 5231 14-0
 Fax: +49 5231 14-292083
 www.weidmueller.com

Product image



Similar to illustration

Relay from the D-SERIES DRM.

- 2 or 4 CO contacts
- Compact design
- Wide range of coil voltages
- Optional test button (AC red, DC blue)
- Optional with integrated status display (AC red, DC green)
and/or free-wheel diode

General ordering data

Type	DRM270024
Order No.	7760056051
Version	D-SERIES DRM, Relay, Number of contacts: 2, CO contact, AgNi 0,15 µm Au, Rated control voltage: 24 V DC, Continuous current: 10 A, Plug-in connection
GTIN (EAN)	4032248856046
Qty.	20 pc(s).

Creation date August 17, 2020 3:37:48 PM CEST

Catalogue status 14.08.2020 / We reserve the right to make technical changes.

D-SERIES DRM
DRM270024

Weidmüller Interface GmbH & Co. KG
 Klingenbergstraße 26
 D-32758 Detmold
 Germany
 Fon: +49 5231 14-0
 Fax: +49 5231 14-292083
 www.weidmueller.com

Technical data**Dimensions and weights**

Width	21 mm	Width (inches)	0.827 inch
Height	27.4 mm	Height (inches)	1.079 inch
Depth	35.7 mm	Depth (inches)	1.406 inch
Net weight	34.95 g		

Temperatures

Humidity	35...85 % rel. humidity, no condensation	Operating temperature, max.	60 °C
Operating temperature, min.	-40 °C	Storage temperature, max.	70 °C
Storage temperature, min.	-40 °C	Operating temperature	-40 °C...60 °C
Storage temperature	-40 °C...70 °C		

Environmental Product Compliance

REACH SVHC	Lead 7439-92-1
------------	----------------

Rated data UL

Certificate No. (cURus)	E312083
-------------------------	---------

Input

Rated control voltage	24 V DC	Rated current DC	37.8 mA
Power rating	0.9 W	Pull-in/drop-out voltage, typ.	18 V / 2.4 V DC
Coil resistance	650 Ω ± 10 %		

Output

Rated switching voltage	250 V AC	Max. switching voltage, AC	250 V
Continuous current	10 A	Inrush current	20 A / 50 ms
AC switching capacity (resistive), max.	2500 VA	DC switching capacity (resistive), max.	240 W @ 24 V
Switch-on delay	< 20 ms	Switch-off delay	< 20 ms
Min. switching power	10 mA @ 12 V, 100 mA @ 5 V	Max. switching frequency at rated load	0.1 Hz

Contact data

Contact type	2 CO contact (AgNi 0,15 µm Au)	Contact resistance	≤ 50 mΩ
Mechanical service life	20 x 10 ⁶ switching cycles		

General data

Test button	No	Mechanical switch position indicator	Yes
Colour	Transparent	UL 94 flammability rating	V-2

Data sheet

**D-SERIES DRM
DRM270024**

Weidmüller Interface GmbH & Co. KG
Klingenbergstraße 26
D-32758 Detmold
Germany
Fon: +49 5231 14-0
Fax: +49 5231 14-292083
www.weidmueller.com

Technical data

Insulation coordination

Rated voltage	250 V	Surge voltage category	III
Pollution severity	2	Protection degree	IP20
Dielectric strength, Input/Output	1.8 kV _{eff} / 1 min.	Creepage and clearance distance input – output	≥ 5.5 mm
Dielectric strength of neighbouring contacts	1 kV _{eff} / 1 min	Dielectric strength of open contact	1 kV _{eff} / 1 min
Impulse withstand voltage	6 kV (1.2/50 µs)		

Further details of approvals / standards

Standards	IEC 61810-1, EN 60664-1:2007, EN 61000-6-2:2005, EN 61000-6-4:2007 + A1:2011, UL 508	Certificate No. (cURus)	E312083
-----------	--	-------------------------	---------

Connection data

Wire connection method	Plug-in connection
------------------------	--------------------

Classifications

ETIM 6.0	EC001437	ETIM 7.0	EC001437
eClass 9.0	27-37-16-01	eClass 9.1	27-37-16-01
eClass 10.0	27-37-16-01		

Approvals

Approvals



ROHS	Conform
------	---------

Downloads

Approval/Certificate/Document of Conformity	EU Konformitätserklärung / EU Declaration of Conformity
Brochure/Catalogue	CAT 4.2 ELECTR 18/19 EN
Engineering Data	EPLAN, WSCAD
Engineering Data	STEP

**D-SERIES DRM
DRM270024**

Weidmüller Interface GmbH & Co. KG
 Klingenbergstraße 26
 D-32758 Detmold
 Germany
 Fon: +49 5231 14-0
 Fax: +49 5231 14-292083
 www.weidmueller.com

Drawings

Wiring diagram

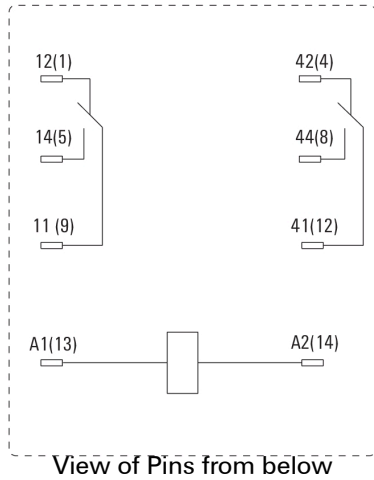

Graph

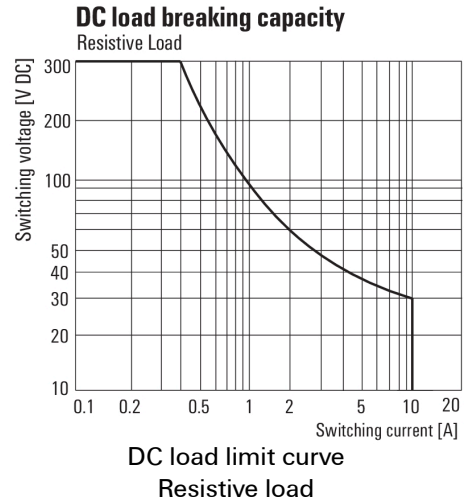

Graph

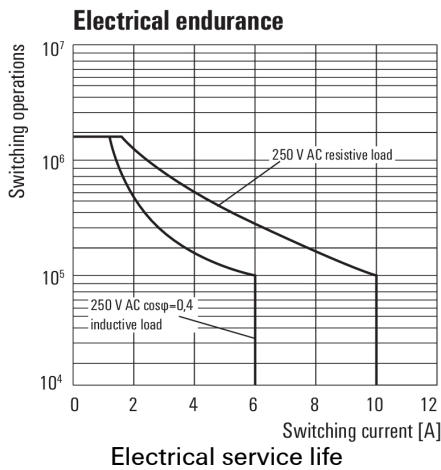

Graph

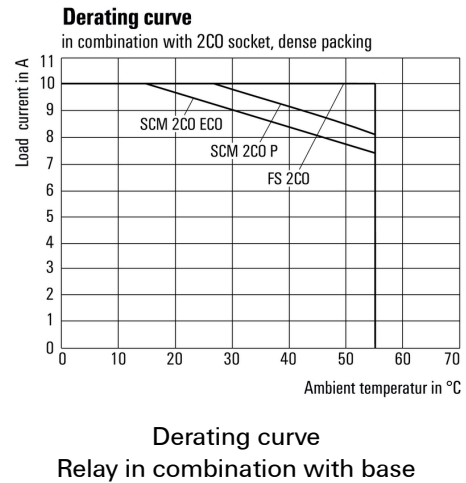

Graph

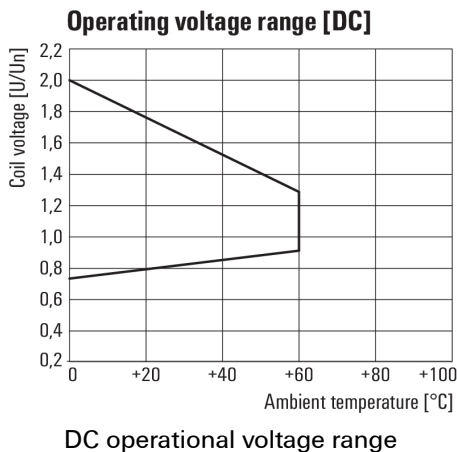

Dimensional drawing

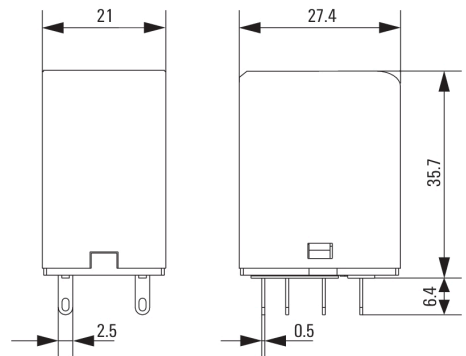

Data sheet

**D-SERIES DRM
DRM270024**

Weidmüller Interface GmbH & Co. KG
 Klingenbergstraße 26
 D-32758 Detmold
 Germany
 Fon: +49 5231 14-0
 Fax: +49 5231 14-292083
 www.weidmueller.com

Drawings

Miscellaneous

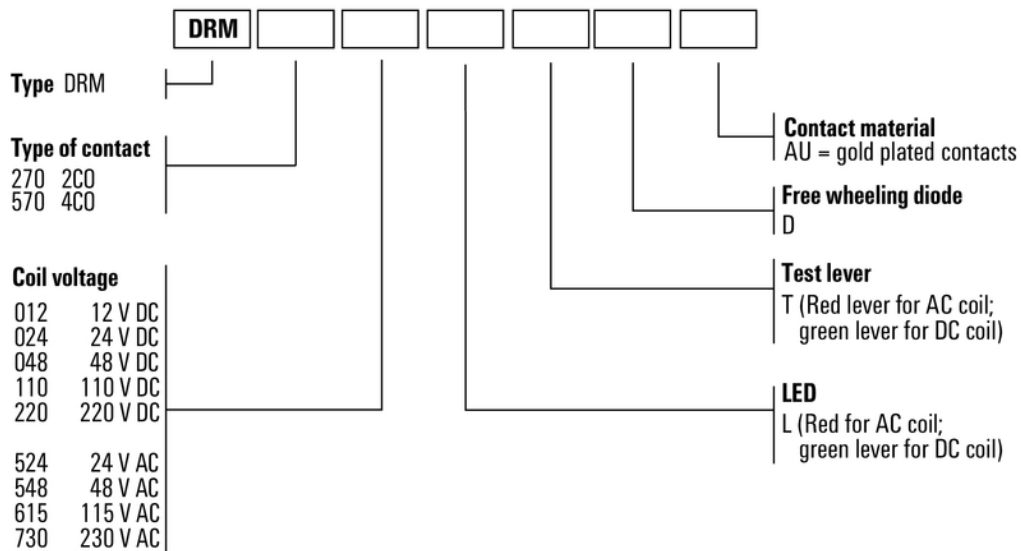

Type codes