

### Steel City® Metallic Boxes & Covers

Steel City® is the industry leading product line of metallic switch and outlet boxes used in electrical construction. Since 1904, Steel City® products have symbolized the highest quality standards in manufacturing and innovative design, with one of the most complete offerings available.

Steel City® products are known for their simple improvements, such as being the first box offering to standardize combination slotted/phillips screws on all boxes. Thomas & Betts is also recognized as a leader in design innovation, as in our new metal stud bracket.

Thomas & Betts continues to listen to contractors and responds to their ever-changing needs. Contact a T&B distributor nearest you to select the right Steel City® product for your requirements.

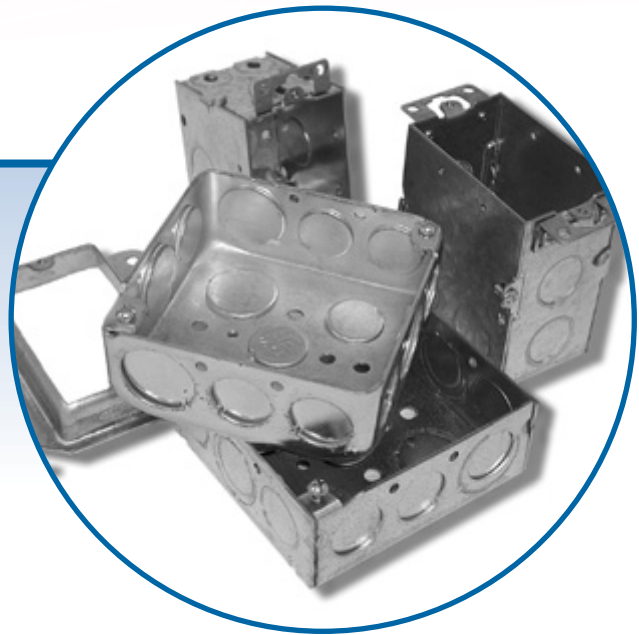

### Advantages of Steel City® Boxes & Covers

#### Notched Ears on Switch Boxes

- Steel City® Switch Boxes feature a longer ear and a special notch. This provides clearance for the screws that are used to attach wall plates to GFCI or rocker-type light switches

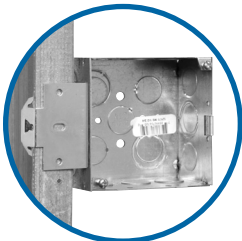

#### "MS" Bracket Boxes

- Mounts without the use of screws
- Mounts to the open or closed side of the stud
- Works on stud depths up to 4"

#### Eccentric Knockouts on Square Boxes

- Provide better contact with conduit fitting and locknut to the box, improves grounding path, stronger than 3/4" knockout
- Available in all four standard size square boxes
- Improved 3/4" knockout position on square boxes
- Less labor required to install 3/4" conduit to box

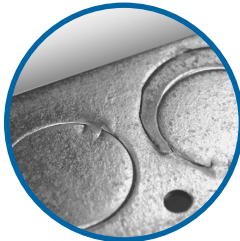

#### Raised Ground Screw Bump in 4" Square, 4 1/16" and Utility Boxes

- Quicker surface mounting by eliminating the need to remove the portion of the screw that threads through the back of the box
- Allows for improved repositioning of grounding conductor
- Ground bump standard in 2 1/2" boxes
- Ground bump optional in 1 1/2" boxes

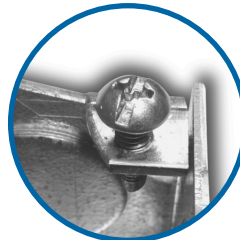

#### Pre-Installed Screws are Packaged in Raised Position

- Eliminates extra step of having to back out the screw during cover installation

Steel City® switch and outlet boxes are protected from rust and corrosion by zinc-galvanizing. All clamps and other component parts are electrogalvanized separately, before assembly in the box, to ensure corrosion protection of every surface. Steel City® galvanized finish meets the requirements of Underwriters Laboratories, Inc. and Federal Specifications.

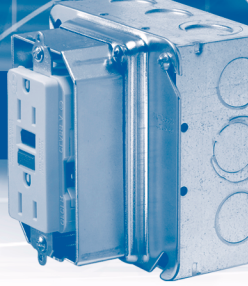

### Guide to Steel City Knockouts, Pryouts, Ears, Brackets and Clamps

#### Knockouts and Pry outs

Steel City conduit KOs have standard trade size dimensions. KOs are uniform and true for attachment of cable or conduit connectors. Pryouts for cable entrance are slotted — a twist with a screwdriver removes them. KOs and Pryouts are precision stamped to permit easy removal, but remain sufficiently strong and sturdy when not removed.

#### Outlet Box Ears

Mounting ears support the box independent of the electrical system attachments. Switch boxes have a fixed ear for old work installations. Ears for plaster are set 1/16" forward of the box face in position for old work (modernization) except where specifically noted.

#### Tapped Holes for Grounding

All Steel City boxes have a 10-32 tapped hole in the bottom of the box for attaching separate ground wire.

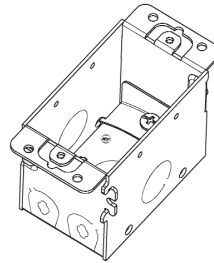

#### Knockouts

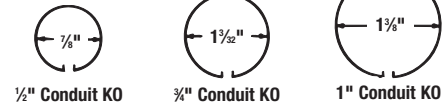

1/2" Conduit KO      3/4" Conduit KO      1" Conduit KO

#### Eccentric Knockouts



Combination 1/2" & 3/4" Knockout

#### Pryouts

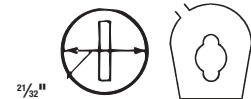

2 1/2"

Cable Pryouts always in Pairs.

#### Brackets

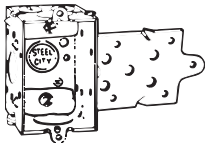

"S" or "B" Type

Mounts to face of stud. Used on switch, handy or square boxes. 2" long — 2 1/4" wide

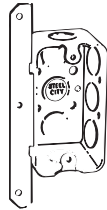

"T" Type

Positions handy box against the face and side of stud. 5 1/2" long — 7/8" wide

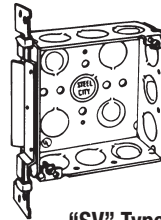

"SV" Type

Mounts box to side of stud with positioning spikes. 7 3/8" long — 1" wide — 3/8" offset

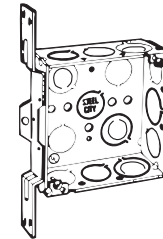

"CV" Type (Outlet Boxes)

Mounts to flat side of metal studs or wood studs. 7 3/8" long — 1" wide — 3/8" offset

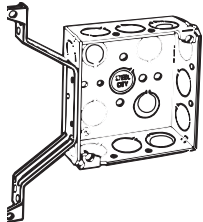

"DV" Type

Mounts box offset from stud 1 1/2". 6 1/8" long — 1" wide — 1/2" offset

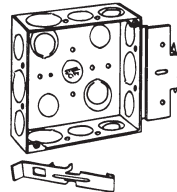

"MS" Type (For Metal Studs)

Mounts to any depth of metal stud, open or closed side. 2 1/2" long — 1 1/8" wide — 3/8" offset

Far side support to 4" only

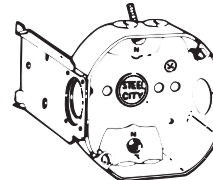

"L" Type

Used to mount octagon boxes. 2 5/8" long — 3 3/8" wide — 1/4" offset

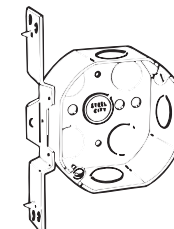

"V" Type

Mounts to flat side of stud. 7 3/8" long — 1" wide — 3/8" offset

#### Clamps



C-1



C-5



C-8

(Loom only)

For Armored Cable



C-3



C-10

#### For Non-Metallic Sheathed Cable and Non-Metallic Tubing (Loom)

UNDERWRITERS LABORATORIES INC. and CANADIAN STANDARDS ASSOCIATION file numbers for individual items available upon request. "Products listed in this catalog are subject to alteration or discontinuation without prior notice."

#### Listing Information for Armored Cable Clamp — Type C-3

Armored Cable (BX) — Steel	Sizes 14-2 through 10-3	MCAP™ — Aluminum*
Armored Cable (BX) — Aluminum	Sizes 14-2 through 10-3	Flex Metal Conduit — Steel
MC Interlocked (MCI) — Steel	.449-.570 Diameter	1/8" Trade Size
MC Interlocked (MCI) — Aluminum	.476-.606 Diameter	Flex Metal Conduit — Aluminum
MC Corrugated (MCC) — Aluminum	.375-.515 Diameter	3/8" Trade Size
		C-3 Clamp Acceptable for Grounding

\* MCAP™ is a trademark of Southwire Company

## NEC Reference

Article 314 of the National Electrical Code covers the installation and use of boxes. The article includes table references that guide the electrician in the selection of the proper box size necessary to safely accommodate electrical service requirements. The box capacity table shown below is reproduced in part from the NEC as a quick reference and guide. The NEC should be consulted for complete details.

## Article 314 — Boxes and Fittings

### 314.16. Number of Conductors in Outlet, Device and Junction Boxes, and Conduit Bodies.

Boxes shall be of sufficient size to provide free space for all conductors enclosed in the box.

The provisions of this section shall not apply to terminal housings supplied with motors or generators. (See Section 430.12.)

Boxes and conduit bodies containing conductors, size No. 4 or larger, shall also comply with the provisions of Section 314.28.

#### (a) Standard Boxes.

The maximum number of conductors permitted in standard boxes are listed in Table 314.16(A) reproduced in part on page A6. See Article 314.28(A) through (D) where boxes or conduit bodies are used as junction or pull boxes.

- (1) Table 314.16(A) shall apply where no fittings or devices, such as fixture studs, cable clamps, hickey, switches, or receptacles, are contained in the box and where no grounding conductors are part of the wiring within the box. Where one or more of these types of fittings, such as fixture studs, cable clamps, or hickey are contained in the box, the number of conductors shown in the table must be reduced by one for each type of fitting; an additional deduction of one conductor must be made for each strap containing one or more devices; and a further deduction of one conductor shall be made for one or more grounding conductors entering the box. Where a second set of equipment grounding conductors, as permitted by Section 250.146(D), is present in the box, then an additional deduction of one conductor must be made. A conductor running through the box is counted as one conductor, and each conductor originating outside of the box and terminating inside the box is counted as one conductor. Conductors, no part of which leaves the box, shall not be counted. The volume of a wiring enclosure (box) shall be the total volume of the assembled sections, and, where used, the space provided by plaster rings, domed covers, extension rings, etc., that are marked with their volume in cubic inches, or are made from boxes the dimensions of which are listed in Table 314.16(A).
- (2) For combinations of conductor sizes shown in Table 314.16(A), the maximum number of conductors permitted is computed using the volume per conductor listed in Table 314.16(B) with the deductions provided for in Section 314.16(B) and these volume deductions shall be based on the largest conductor entering the box. The maximum number and size of conductors listed in Table 314.16(A) must not be exceeded.

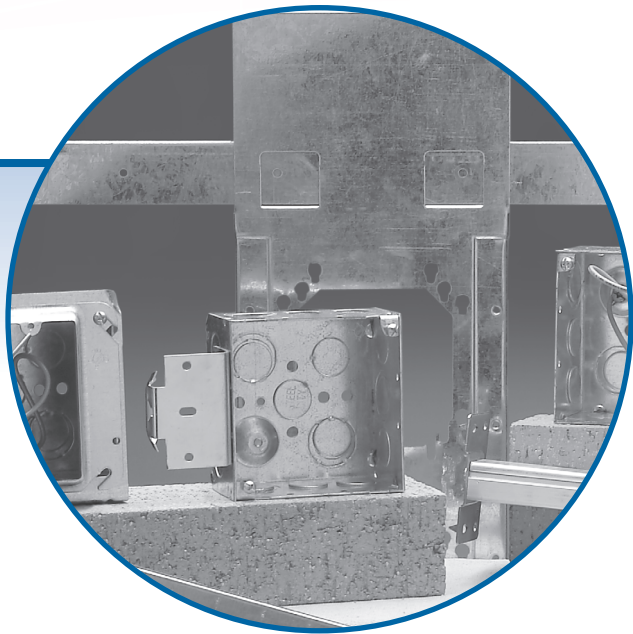

#### (b) Other Boxes.

Boxes 100 cubic inches or less, other than those described in Table 314.16(A), conduit bodies having provisions for more than two conduit entries and non-metallic boxes shall be durably and legibly marked by the manufacturer with their cubic inch capacity. The maximum number of conductors permitted shall be computed using the volume per conductor listed in Table 314.16(A), with the deductions provided for in Section 314.16(B), and these volume deductions shall be based on the largest conductor entering the box. Boxes described in Table 314.16(A) that have a larger cubic inch capacity than is designated in the table shall be permitted to have their cubic inch capacity marked as required by this section and the maximum number of conductors permitted shall be computed using the volume per conductor listed in Table 314.16(B).

#### (c) Conduit Bodies.

Conduit bodies enclosing 6AWG conductors or smaller other than short-radius conduit bodies as described in 314.5, shall have a cross-sectional area not less than twice the cross-sectional area of the largest conduit to which they can be attached. The maximum number of conductors permitted shall be the maximum number permitted by Table I, Chapter 9, for the conduit to which it is attached.

Conduit bodies that are durably and legibly marked by a manufacturer with their volume shall be permitted to contain splices, taps or devices. The maximum number of conductors shall be calculated in accordance with 314.16(B) and are supported in a rigid and secure manner.



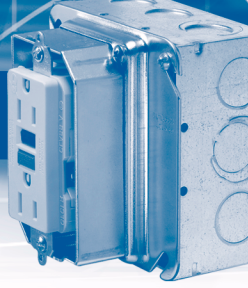

### Article 314 — Boxes and Fittings (continued)

**Table 314.16(A)**  
**Metal Boxes**

MM	BOX TRADE SIZE (IN.)		MINIMUM VOLUME		MAXIMUM NUMBER OF CONDUCTORS*						
			CM3	IN.3	18	16	14	12	10	8	6
100 x 32	(4 x 1¼)	Round/Octagonal	205	12.5	8	7	6	5	5	5	2
100 x 38	(4 x 1½)	Round/Octagonal	254	15.5	10	8	7	6	6	5	3
100 x 54	(4 x 2¼)	Round/Octagonal	353	21.5	14	12	10	9	8	7	4
100 x 32	(4 x 1¼)	Square	295	18.0	12	10	9	8	7	6	3
100 x 38	(4 x 1½)	Square	344	21.0	14	12	10	9	8	7	4
100 x 54	(4 x 2¼)	Square	497	30.3	20	17	15	13	12	10	6
120 x 32	(4L x 1¼)	Square	418	25.5	17	14	12	11	19	8	5
120 x 38	(4L x 1½)	Square	484	29.5	19	16	14	13	11	9	5
120 x 54	(4L x 2¼)	Square	689	42.0	28	24	21	18	16	14	8
75 x 50 x 38	(3 x 2 x 1½)	Device	123	7.5	5	4	3	3	3	2	1
75 x 50 x 50	(3 x 2 x 2)	Device	164	10.0	6	5	5	4	4	3	2
75 x 50 x 57	(3 x 2 x 2¼)	Device	172	10.5	7	6	5	4	4	3	2
75 x 50 x 65	(3 x 2 x 2½)	Device	205	12.5	8	7	6	5	5	4	2
75 x 50 x 70	(3 x 2 x 2¾)	Device	230	14.0	9	8	7	6	5	4	2
75 x 50 x 90	(3 x 2 x 3½)	Device	295	18.0	12	10	9	8	7	6	3
100 x 54 x 38	(4 x 2¼ x 1½)	Device	169	10.3	6	5	5	4	4	3	2
100 x 54 x 48	(4 x 2¼ x 1¾)	Device	213	13.0	8	7	6	5	5	4	2
100 x 54 x 54	(4 x 2¼ x 2¼)	Device	238	14.5	9	8	7	6	5	4	2
95 x 50 x 65	(3¾ x 2 x 2¼)	Masonry Box/Gang	230	14.0	9	8	7	6	5	4	2
95 x 50 x 90	(3¾ x 2 x 3½)	Masonry Box/Gang	244	21.0	14	12	10	9	8	7	2
Min. 44.5 depth	FS – Single Cover/Gang (1¾)		221	13.5	9	7	6	6	5	4	2
Min. 60.3 depth	FD – Single Cover/Gang (2¾)		295	18.0	12	10	9	8	7	6	3
Min. 44.5 depth	FS – Multiple Cover/Gang (1¾)		295	18.0	12	10	9	8	7	6	3
Min. 60.3 depth	FD – Multiple Cover/Gang (2¾)		395	24.0	16	13	12	10	9	8	4

\*Where no volume allowances are required by 314.16(B)(2) through 314.16(B)(5).

Underwriters Laboratories Inc. File Number: E2969 (U.L. 514A)

Canadian Standards Association File Number: LR 12798

Federal Manufacture Number: 56501 (Cage Code)

Products designed to meet Federal Specification Number: W-J-800

Verification of file numbers and compliance with federal specifications for individual items available upon request.

Box and cover material and plating specification; .062" minimum thickness, hot rolled, pre-galvanized steel, minimum spangle.

ASTM G-60-U, AISI C-1008

Bracket material: All brackets except MS style; 16 gauge (.060") hot rolled, pre-galvanized steel AISI C-1008, G-90-U. MS style bracket; 20 gauge (.036") cold rolled spring steel AISI C-1055, heat treated to R. 35 zinc plated .0005 thick.

**Table 314.16(B)**  
**Volume Allowance Required per Conductor**

SIZE OF CONDUCTOR (AWG)	FREE SPACE WITHIN BOX FOR EACH CONDUCTOR	
	CM <sup>3</sup>	IN. <sup>3</sup>
No. 18	24.6	1.50
No. 16	28.7	1.75
No. 14	32.8	2.00
No. 12	36.9	2.25
No. 10	41.0	2.50
No. 8	49.2	3.00
No. 6	81.9	5.00

Reprinted with permission from National Fire Protection Association 70-1987. National Electrical Code, Copyright© 1986, National Fire Protection Association, Quincy, MA 02269. This reprinted material is not the complete and official position of the NFPA on the referenced subject which is represented only by the standard in its entirety.

NEC® is a registered trademark of the National Fire Protection Association, Inc., Quincy, MA 02269.

Underwriters Laboratories Inc. File Number: E2969 (U.L. 514A)

Canadian Standards Association File Number: LR 12798

Federal Manufacture Number: 56501

Products designed to meet Federal Specification Number: A-A5924 (formerly W-J-800).

Verification of file numbers and compliance with federal specifications for individual items available upon request.

Box and cover material and plating specification; .062" minimum thickness, hot rolled, pre-galvanized steel, minimum spangle.

ASTM G-60-U, AISI C-1008

Bracket material: All brackets except MS style; 16 gauge (.060") hot rolled, pre-galvanized steel AISI C-1008, G-60-U. MS Style bracket; 20 gauge (.036") cold rolled spring steel AISI C-1055, heat treated to R. 35 zinc plated .0005 thick.

### Metallic Boxes — Fire Resistance Rating

#### Wall Penetrations

Listed single and double gang metallic outlet and switch boxes and octagon ceiling boxes with metallic or non-metallic cover plates may be used in bearing and non-bearing wood stud and steel stud walls with ratings not exceeding 2 hours. These walls shall have gypsum wallboard facings similar to those shown in Design Nos. U301, U411, and U425. 4 in. square boxes may be used in 2 hr. fire rated ceilings.

The surface area of individual metallic outlet or switch boxes shall not exceed 16 sq. in. The aggregate surface area of the boxes shall not exceed 100 sq. inches per 100 sq. ft. of wall. Boxes located on opposite sides of walls or partitions shall be separated by a horizontal distance of 24 inches.

The metallic outlet or switch boxes shall be securely fastened to the studs and the opening in the wallboard facing shall be cut so that the clearance between the box and the wallboard does not exceed ¼ in.



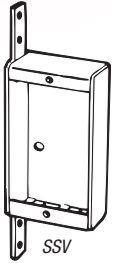

SSV

SSQV  
With  
non-metallic  
sheathed  
cable clamps



### 3¾" x 2" Switch Boxes

CAT. NO.	CLAMPS	EARS	BRKTS.	KNOCKOUTS	STD. CTN.
<b>1" Deep Non-Gangable — 6.5 Cubic Inch Capacity</b>					
SSV	—	—	Flat	2 pry-outs one end	25
SSQV	Yes	—	Flat	2 pry-outs one end with non-metallic cable clamps	25

Not U.L. Listed.

### 3" x 2" Switch Boxes



SWB-25

Ears flush for old work

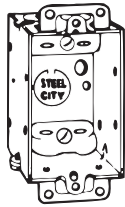

LXMWOW-25

Ears flush for old work



LXMOW-25

Ears flush for old work

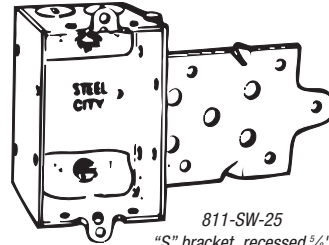

811-SW-25

"S" bracket recessed ¾"



LCOW-25

Ears flush old work

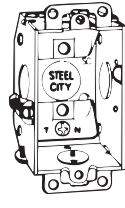

LCOWC

Adapts to any wall thickness up to ¾"



LCLE-25



LCV-25

"CV" bracket recessed ¾"

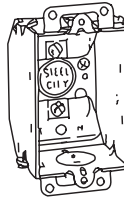

LCNOW-25

Ears flush old work

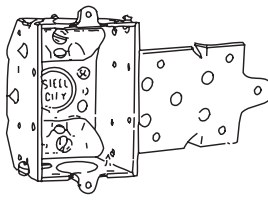

802-S

"S" bracket recessed ¾"



A-12-25



A-12E-25

Ears flush

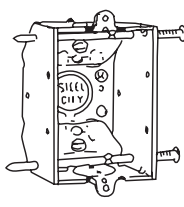

A-16-25

With nails

CAT. NO.	CLAMPS	EARS	BRKTS.	KNOCKOUTS			STD. CONDUIT CTN.
				EA. END	EA. END	BOTTOM	
<b>1½" Deep Non-Gangable — with Non-Metallic Sheathed Cable Clamps — 7.5 Cubic Inch Capacity</b>							
SWB-25	C-5	Yes	—	—	2	—	25
811 SW-25	C-5	—	S	—	2	—	50

#### 2" Deep Gangable — with Non-Metallic Cable Clamps — 10.5 Cubic Inch Capacity

LXMWOW-25	C-5	Yes	—	—	2	—	1-½"	25
-----------	-----	-----	---	---	---	---	------	----

#### 2" Deep Gangable — with Armored Cable/Metal Clad Clamps — 10.5 Cubic Inch Capacity

LXMOW-25	C-3	Yes	—	—	2	—	1-½"	25
----------	-----	-----	---	---	---	---	------	----

#### 2¼" Deep Gangable — Beveled Corners — with Non-Metallic Sheathed Cable Clamps — 10.5 Cubic Inch Capacity

LCOW-25	C-1	Yes	—	1-½"	—	2	—	1-½"	25
LCOWC	C-1	Yes	—	1-½"	—	2	—	1-½"	25
LCLE-25	C-1	—	—	1-½"	—	2	—	1-½"	25
LCV-25	C-1	—	CV	1-½"	—	2	—	1-½"	25
LCNOW-25	C-1	Yes	—	1-½"	—	2	—	1-½"	25
802 S	C-1	—	S	1-½"	—	2	—	1-½"	25

#### 2¼" Deep Non-Gangable — with Non-Metallic Sheathed Cable Clamps — 10.5 Cubic Inch Capacity

A12-25	C-1	—	—	1-½"	—	2	—	1-½"	25
A12E-25	C-1	Yes	—	1-½"	—	2	—	1-½"	25
A16-25	C-1	—	—	1-½"	—	2	—	1-½"	25

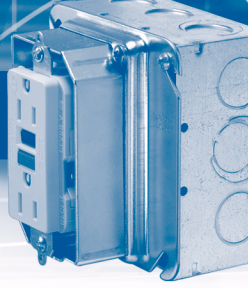

### 3" x 2" Switch Boxes (continued)

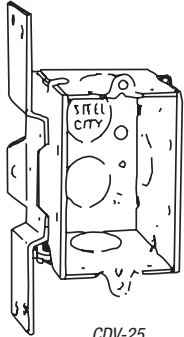

CDV-25  
"CV" bracket recessed 1/4"

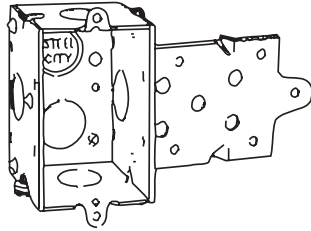

804 S  
"S" bracket recessed 1/4"

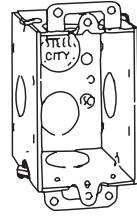

CDOW  
Ears flush

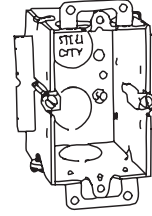

CDOWTG-25  
Ears flush

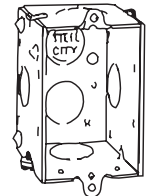

CDLE-25

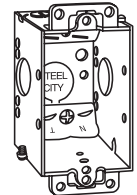

LXWOW-25  
Ears flush for old work

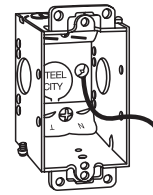

LXWOWP

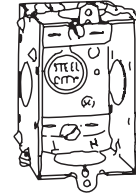

LXWLE-25



LXWOWC-25  
Adapts to any wall  
thickness up to 1/4"

CAT. NO.	BRKTS.	EARS	KNOCKOUTS			STD. CTN.
			EA. SIDE CONDUIT	EA. END CONDUIT	BOTTOM CONDUIT	
<b>2 1/2" Deep Gangable — with Conduit KOs — 12.5 Cubic Inch Capacity</b>						
CDOW	—	Yes	1 1/2"	1 1/2"	2 1/2"	50
CDOWTG-25	—	Yes	1 1/2"	1 1/2"	2 1/2"	25
CDLE-25	—	—	1 1/2"	1 1/2"	2 1/2"	25
CDV-25	CV	—	1 1/2"	1 1/2"	2 1/2"	25
804 S	S	—	1 1/2"	1 1/2"	2 1/2"	25

CAT. NO.	CLAMPS	EARS	BRKTS.	KNOCKOUTS			STD. CTN.	
				EA. SIDE CONDUIT	EA. END CONDUIT	BOTTOM CABLE		
<b>2 1/2" Deep Gangable — with Non-Metallic Sheathed Cable Clamps — 12.5 Cubic Inch Capacity</b>								
LXWOW-25	C-5	Yes	—	1-1/2"	—	2	1-1/2"	25
LXWOWP	C-5	Yes	—	1-1/2"	—	2	1-1/2"	25
LXWLE-25	C-5	—	—	1-1 1/2"	1-1/2"	2	1-1/2"	25
LXWOWC-25	C-5	Yes	—	1-1/2"	—	2	1-1/2"	25
LXWSV	C-5	—	SV	1-1/2"	1-1/2"	2	1-1/2"	25
LXWV-25	C-5	—	CV	1-1/2"	1-1 1/2"	2	1-1/2"	25
LXWV 2G	C-5	—	CV	1-1/2"	2-1/2"	4	2-1/2"	25
806 SW	C-5	—	S	1-1/2"	1-1/2"	2	1-1/2"	25
806 SW 1/4	C-5	—	S	1-1/2"	1-1 1/2"	2	1-1/2"	25

<b>2 1/2" Deep Non-Gangable — with Non-Metallic Sheathed Cable Clamps — 12.5 Cubic Inch Capacity</b>								
A254-25	C-5	—	—	—	1-1/2"	2	1-1/2"	25
A257-25	C-5	—	—	—	1-1/2"	2	1-1/2"	25
A-258	C-5	—	—	—	1-1/2"	2	1-1/2"	25

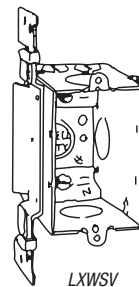

LXWSV  
"SV" bracket  
recessed 1/16"



LXWV-25  
"CV" bracket  
recessed 1/8"

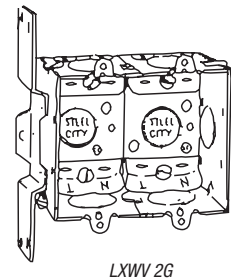

LXWV 2G  
2-gang with "CV"  
bracket recessed 1/8"

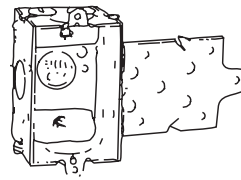

806-SW  
"S" bracket recessed 5/8"

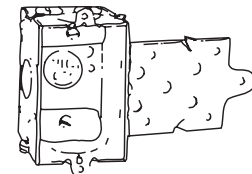

806-SW-1/4  
"S" bracket recessed 1/4"

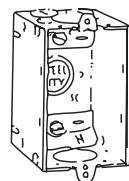

A-254-25

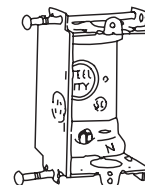

A-257-25  
With nails slanted  
for easy drive-in



A-258  
Without nails



**LXOWC-25**  
Adapts to 3/4" wall thickness



**LXLE**



**LXV-25**  
"CV" bracket recessed 3/8"

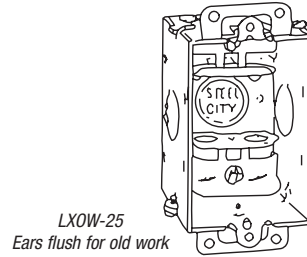

**LXOW-25**  
Ears flush for old work

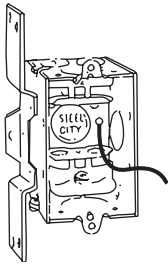

**LXVP**

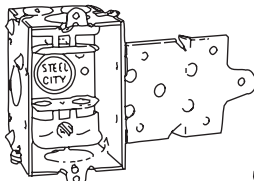

**806-S**  
"S" bracket recessed 3/8"

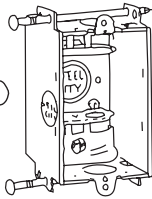

**A-256**  
With nails slanted for easy drive-in

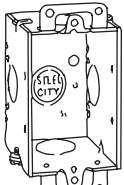

**CW34-25**  
Ears flush



**CWLE1/2-25**

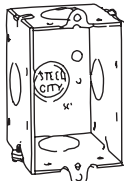

**CWLE 3/4**



**CW-1/2**  
Ears flush



**CWV 1/2**  
"CV" bracket recessed 3/8"

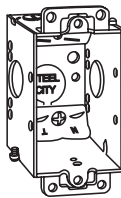

**CWN-25**  
Ears flush

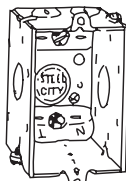

**CWNLE**

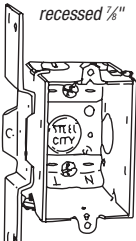

**CWNV-25**  
"CV" bracket recessed 3/8"

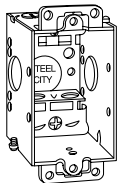

**CWX-25**  
Ears flush

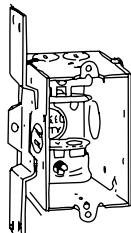

**CWXV-25**  
"CV" bracket recessed 3/8"

### 3" x 2" Switch Boxes (continued)

CAT. NO.	CLAMPS	EARS	BRKTS.	KNOCKOUTS			STD. CTN.
				EA. SIDE CONDUIT	EA. END CONDUIT	BOTTOM CABLE CONDUIT	

#### 2 1/2" Deep Gangable — with Armored Cable/Metal Clad Clamps — 12.5 Cubic Inch Capacity

<b>LXOW-25</b>	C-3	Yes	—	1-1/2"	—	2	1-1/2"	25
<b>LXOWC-25</b>	C-3	Yes	—	1-1/2"	—	2	1-1/2"	25
<b>LXLE</b>	C-3	—	—	1-1/2"	1-1/2"	2	1-1/2"	25
<b>LXV-25</b>	C-3	—	CV	1-1/2"	1-1/2"	2	1-1/2"	25
<b>LXVP</b>	C-3	—	CV	1-1/2"	1-1/2"	2	1-1/2"	25
<b>806 S</b>	C-3	—	S	1-1/2"	1-1/2"	2	1-1/2"	25

#### 2 1/2" Deep Non-Gangable — with Armored Cable/Metal Clad Clamps — 12.5 Cubic Inch Capacity

<b>A-256</b>	C-3	—	—	—	1-1/2"	2	1-1/2"	25
--------------	-----	---	---	---	--------	---	--------	----

CAT. NO.	CLAMPS	EARS	BRKTS.	KNOCKOUTS			STD. CTN.
				EA. SIDE CONDUIT	EA. END CONDUIT	BOTTOM CABLE CONDUIT	

#### 2 3/4" Deep Gangable — with Conduit KOs — 14.0 Cubic Inch Capacity

<b>CW 1/2</b>	—	Yes	—	1-1/2"	1-1/2"	—	1-1/2"	50
<b>CW3/4-25</b>	—	Yes	—	1-3/4"	1-3/4"	—	1-3/4"	25
<b>CWLE1/2-25</b>	—	—	—	1-1/2"	1-1/2"	—	1-1/2"	25
<b>CWLE 3/4</b>	—	—	—	1-3/4"	1-3/4"	—	1-3/4"	25
<b>CWV 1/2</b>	—	—	CV	1-1/2"	1-1/2"	—	1-1/2"	25

#### 2 3/4" Deep Gangable — with Non-Metallic Sheathed Cable Clamps — 14.0 Cubic Inch Capacity

<b>CWN-25</b>	C-5	Yes	—	1-1/2"	—	2	1-1/2"	25
<b>CWNLE</b>	C-5	—	—	1-1/2"	—	2	1-1/2"	25
<b>CWNV-25</b>	C-5	—	CV	1-1/2"	—	2	1-1/2"	25

#### 2 3/4" Deep Gangable — with Armored Cable/Metal Clad Clamps — 14.0 Cubic Inch Capacity

<b>CWX-25</b>	C-3	Yes	—	1-1/2"	—	2	1-1/2"	25
<b>CWXV-25</b>	C-3	—	CV	1-1/2"	—	2	1-1/2"	25



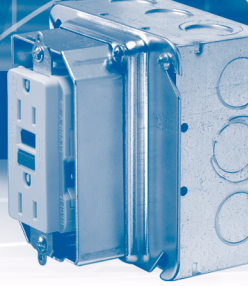

### 3" x 2" Switch Boxes (continued)

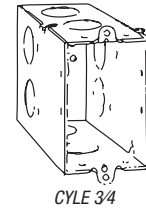
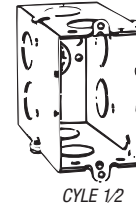
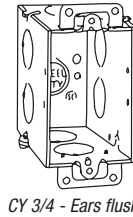
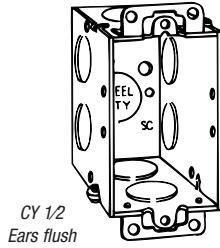

CAT. NO.	CLAMPS	EARS	BRKTS.	KNOCKOUTS			WT. PER C	STD. CTN.
				EA. SIDE CONDUIT	EA. END CONDUIT	BOTTOM CABLE		
<b>3 1/2" Deep Gangable — with Conduit KOs — 18.0 Cubic Inch Capacity</b>								
CY 1/2	—	Yes	—	2-1/2"	2-1/2"	—	75	25
CY 3/4	—	Yes	—	2-3/4"	2-3/4"	—	72	25
CYLE 1/2	—	—	—	2-1/2"	2-1/2"	—	70	25
CYLE 3/4	—	—	—	2-3/4"	2-3/4"	—	70	25
<b>3 1/2" Deep Gangable — with Non-Metallic Sheathed Cable Clamps — 18.0 Cubic Inch Capacity</b>								
CXWLE	C-5	—	—	2-1/2"	1-1/2"	2	75	25
CXWOW	C-5	Yes	—	2-1/2"	1-1/2"	2	77	25
CXWOWP	C-5	Yes	—	2-1/2"	1-1/2"	2	77	25
CXWV	C-5	—	CV	2-1/2"	1-1/2"	2	84	25
CXWVP	C-5	—	CV	2-1/2"	1-1/2"	2	84	25
<b>3 1/2" Deep Gangable — with Armored Cable/Metal Clad Clamps — 18.0 Cubic Inch Capacity</b>								
CX	C-3	Yes	—	2-1/2"	1-1/2"	2	79	25
CXLE-SSX	C-3	No	SSX	2-1/2"	1-1/2"	2	87	25
CXP	C-3	Yes	—	2-1/2"	1-1/2"	2	79	25
CXV	C-3	—	CV	2-1/2"	1-1/2"	2	87	25

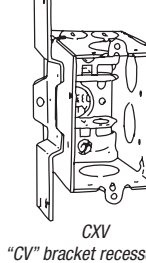
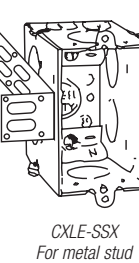
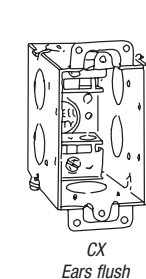
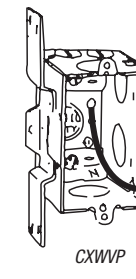
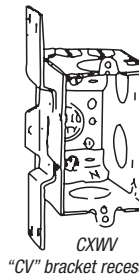
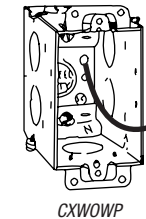
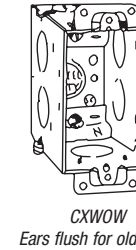
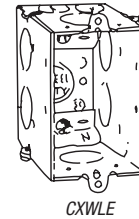

### 4" x 2 1/6" Thru-Wall Box

CAT. NO.	KNOCKOUTS	CU. IN. CAP.	BOX DEPTH (IN.)	STD. CTN.
<b>With Conduit KOs for Plaster or Dry Wall</b>				
CTDW	Drywall, partition type; one 1/2" and one 3/4" KO both ends; one 1/2" KO on one side, "V" bracket other side	32.0	4 5/16	25

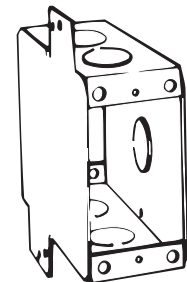

CTDW

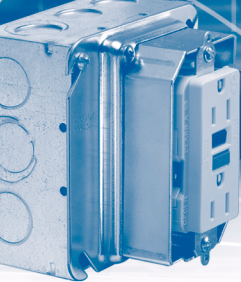

# Steel City®

## Switch Boxes, Accessories

### Switch Box Supports

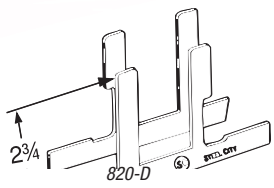

CAT. NO.	DESCRIPTION	STD. CTN.
820-D	Two metal holders for mounting old-work switch boxes in all types of wall materials (1/2" max. thickness)	500 Sets

### Switch Box Extension

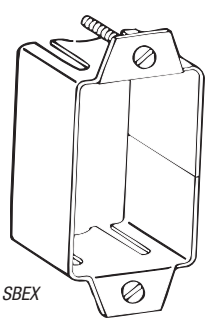

CAT. NO.	DESCRIPTION	STD. CTN.
SBEX	Cubic content 3.5 inches; fits snugly inside of all single gang switch boxes; maximum adjustable depth 7/8"; furnished with 1 1/4" long screws for mounting	50

*UL Listing not applicable — subject to approval by local inspector.*

### Steel Low Voltage Bracket

- Fixes to the switch box easily with the screws provided
- Works with any Steel City® or Bowers® switch box, regardless of depth
- Single screw fixing as well as two screw fixing
- Low voltage cable support is provided by fitting location tabs
- UL listed for low voltage support

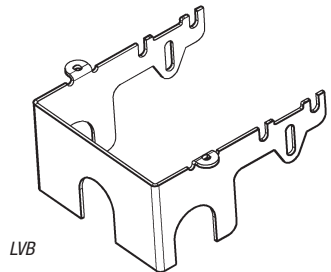

CAT. NO.	KNOCKOUTS	BOX DEPTH (IN.)	STD. CTN.
LVB	Bracketed to T&B boxes; provides means of installing a low-voltage device alongside a regular switch or outlet	1 1/2	25

### Old Work Box Support Clips

- Adapts to any wall thickness up to 3/4"

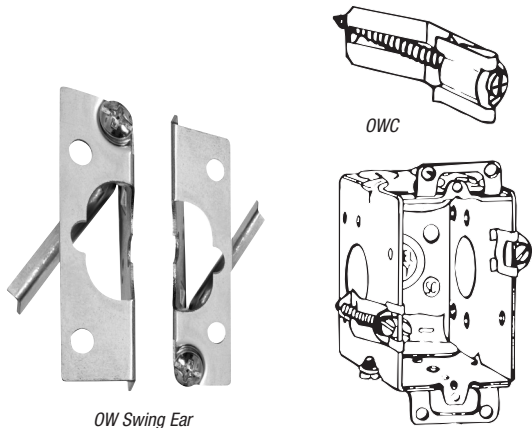

CAT. NO.	DESCRIPTION	STD. CTN.
OWC	Clips lock old-work steel switch boxes tightly to wall plaster, drywall, concrete block, brick, or concrete. 2 required per box, (1 set)	250 sets
OW SWING EAR	Swing ears only (for field installations) with self-threading screws	50 (25 pair)

## Round Boxes and Accessories, Octagon Boxes

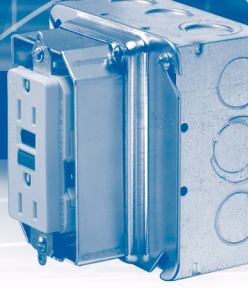

### 4" Round Boxes

CAT. NO.	DESCRIPTION	KNOCKOUTS		STD. CTN.
		BOTTOM CONDUIT		
<b>½" Deep — with Conduit KOs — 6.0 Cubic Inch Capacity</b>				
56111	Steel outlet box	4-½"		50
56111-CFB*	Ceiling fan box with plastic Romex connector included. NC501-SC	2-½"		10

\*Meets NEC 370-17(c) up to 35 lb. fan.

56111-CFB is shipped with plastic cover and all hardware.

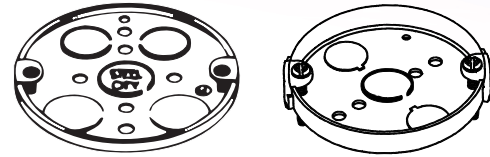

56111

56111-CFB

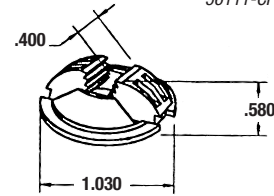

NC501-SC  
(included with 56111-CFB)

### 3½" Round Boxes

CAT. NO.	CLAMPS	KNOCKOUTS		STD. CTN.
		BOTTOM CONDUIT	CABLE	
<b>½" Deep — with Non-Metallic Sheathed Cable Clamps — 4.0 Cubic Inch Capacity</b>				
36115 C30	C-8	1-½"	4	30
<b>¾" Deep — with Non-Metallic Sheathed Cable Clamps — 5.5 Cubic Inch Capacity</b>				
36125 D	C-10	1-½"	4	25

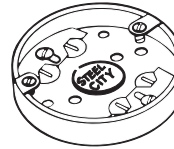

36115 C30

Cover screws supplied

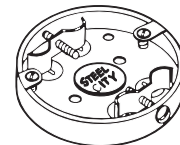

36125 D

Cover screws supplied

### 3½" Round and Octagon Covers

CAT. NO.	DESCRIPTION	STD. CTN.
<b>For 3½" Octagon and Round Boxes</b>		
24C1-25	Flat, blank	100
24-C-6	Flat with ½" KO	25



24C1-25



24-C-6

### 3½" Octagon Boxes

CAT. NO.	CLAMPS	KNOCKOUTS					STD. CTN.
		EA. SIDE CLAMPS	EA. SIDE CONDUIT	EA. END CONDUIT	EA. END CABLE	BOTTOM CONDUIT	
<b>1½" Deep — with Conduit KOs — 11.8 Cubic Inch Capacity</b>							
241511/2-25	—	—	1-½"	1-½"	—	1-½"	50
25151 1/2	—	—	1-½"	1-½"	—	—	50
<b>1½" Deep — with Non-Metallic Sheathed Cable Clamps — 11.8 Cubic Inch Capacity</b>							
24151N-25	C-5	—	1-½"	—	2	1-½"	50
24151-NV	C-5	—	1-½"	—	2	1-½"	50



241511/2-25

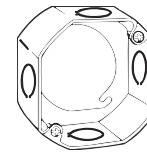

25151 1/2

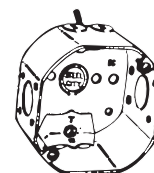

24151N-25

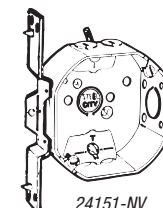

24151-NV

"V" bracket recessed ½"





54151 N

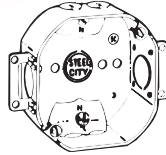

54151 NE

Adjustable ears recessed 5/8"

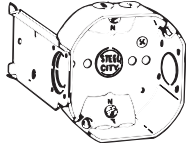

54151 NL

"L" bracket flush mounted

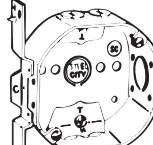

54151 NV

"V" bracket recessed 1/2"

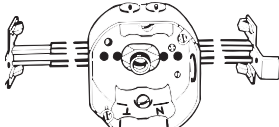

54151 NF

Octagon box mounted on adjustable bar hanger. 50 lb. load max rating

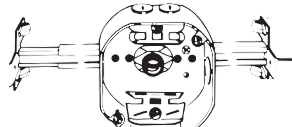

54151 AF

Octagon box mounted on adjustable bar hanger 50 lb. load max rating



54151 1/2



54151 3/4

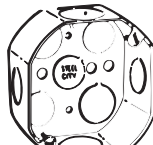

54151 1/2 & 3/4

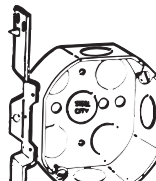

54151 V 1/2

"V" bracket recessed 1/2"

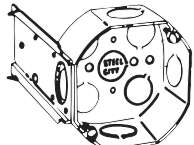

54151 L 1/2

"L" bracket flush mounted

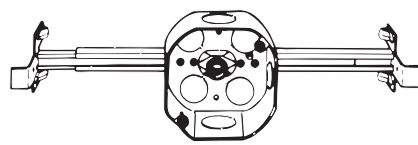

54151 J 1/2

Mounted on 6010-DW bar adjustable 10 1/2" to 18 1/2". Offset for 1/2", 3/4" or 1/2" plaster. Maximum horizontal positioning. 3/8" fixture stud.



54151 A

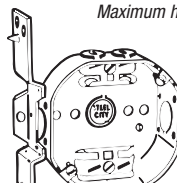

54151AV 25

"V" bracket recessed 1/2"

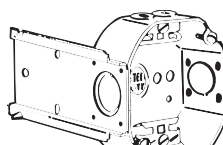

54151 AL

"L" bracket mounted flush

### 4" Octagon Boxes

CAT. NO.	CLAMPS	EARS	BRKTS.	KNOCKOUTS				STD. CTN.
				EA. SIDE CONDUIT	EA. END CONDUIT	EA. END CABLE	BOTTOM CONDUIT	

#### 1 1/2" Deep — with Non-Metallic Sheathed Cable Clamps — 15.8 Cubic Inch Capacity

54151 N	C-5	—	—	1-1/2"	—	2	1-1/2"	50
54151 NE	C-5	—	—	1-1/2"	—	2	1-1/2"	50
54151 NL	C-5	—	L	1-1/2"	—	2	1-1/2"	50
54151 NV	C-5	—	V	1-1/2"	—	2	1-1/2"	50

CAT. NO.	BAR HANGER NUMBER	BAR LGTH. (IN.)	OFFSET FOR	STUD	STD. CTN.
----------	-------------------	-----------------	------------	------	-----------

#### 1 1/2" Deep — for Non-Metallic Sheathed Cable — 15.8 Cubic Inch Capacity

54151 NF	6010-DW	10 1/2-18 1/2	—	3/8"	25
54151 NO	6010-ADW	14 1/2-26 1/2	—	3/8"	25
54151 NG	6011-DW	10 1/2-18 1/2	—	Fastener	25
54151 NP	6011-ADW	14 1/2-26 1/2	—	Fastener	25

#### 1 1/2" Deep — for Armored Cable/Metal Clad — 15.8 Cubic Inch Capacity

54151 AF	6010-DW	10 1/2-18 1/2	Drywall	3/8"	25
----------	---------	---------------	---------	------	----

50 lb. maximum loading for fixtures.

CAT. NO.	CLAMPS	EARS	BRKTS.	KNOCKOUTS				STD. CTN.
				EA. SIDE CONDUIT	EA. END CONDUIT	EA. END CABLE	BOTTOM CONDUIT	

#### 1 1/2" Deep — with Conduit KOs — 15.8 Cubic Inch Capacity

54151 1/2	—	—	—	1-1/2"	1-1/2"	—	5-1/2"	50
54151 3/4	—	—	—	1-3/4"	1-3/4"	—	3-1/2"	50
54151 1/2 & 3/4	—	—	—	1-1/2"	1-3/4"	—	3-1/2"	50
							2-3/4"	
54151 V 1/2	—	—	V	1-1/2"	1-1/2"	—	5-1/2"	25
54151 L 1/2	—	—	L	1-1/2"	1-1/2"	—	5-1/2"	25
54151 J 1/2	—	—	With bar hanger	1-1/2"	1-1/2"	—	4-1/2"	25

#### 1 1/2" Deep — with Armored Cable/Metal Clad Clamps — 15.8 Cubic Inch Capacity

54151 A	C-3	—	—	1-1/2"	—	2	1-1/2"	25
54151AV-25	C-3	—	V	1-1/2"	—	2	1-1/2"	50
54151 AL	C-3	—	L	1-1/2"	—	2	1-1/2"	25

50 lb. maximum loading for fixtures.

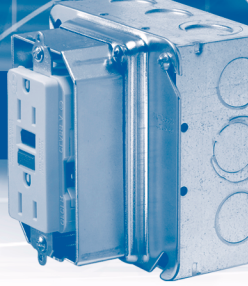

### 4" Octagon Boxes (continued)

CAT. NO.	CLAMPS	BRKTS.	KNOCKOUTS			BOTTOM CONDUIT	STD. CTN.
			EA. SIDE CONDUIT	EA. END CONDUIT	EA. END CABLE		
<b>2 1/2" Deep — with Conduit KOs — 22.5 Cubic Inch Capacity</b>							
541711/2-25	—	1-1/2"	1-1/2"	—	5-1/2"	50	—
54171 3/4	—	1-3/4"	1-3/4"	—	3-1/2"	25	—
							2-3/4" —
54171 1/2 3/4	—	1-1/2"	1-3/4"	—	3-1/2"	25	—
							2-3/4" —
54171 1	—	—	1-1"	1-1"	—	3-1/2"	25
							2-3/4" —
<b>2 1/2" Deep — with Non-Metallic Sheathed Cable Clamps — 22.5 Cubic Inch Capacity</b>							
54171N-25	C-5	—	1-1/2"	—	2	1-1/2"	50
54171 NL	C-5	L	1-1/2"	—	2	1-1/2"	50
54171NV-25	C-5	V	1-1/2"	—	2	1-1/2"	25

50 lb. maximum loading for fixtures.

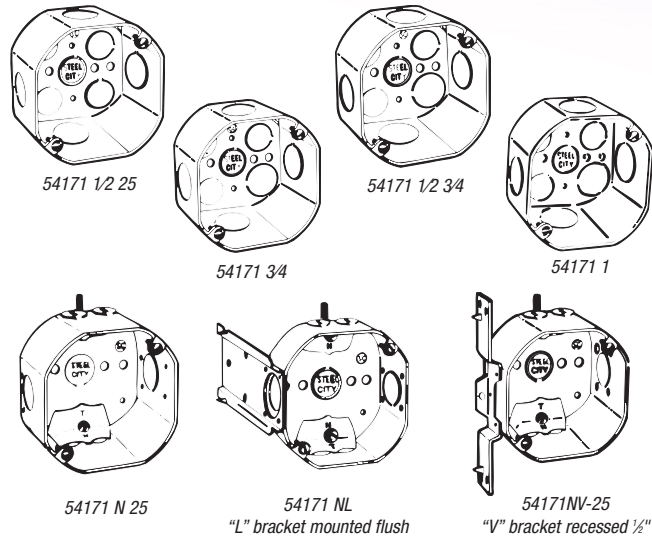

Steel City® Metallic Boxes and Covers

### 4" Round and Octagon Box Covers

CAT. NO.	RAISED	DESCRIPTION	CU. IN. CAP.	STD. CTN.
54 C 1	—	Flat, blank	—	50
54 C 6	—	Flat, with 1/2" KO	—	50
54 C 7	5/8"	With 1/2" KO	3.5	25
54 C 3 1/2	1/2"	Center blanked with tapped ears on 2 3/4" centers	3.0	25
54 C 3	5/8"	Center blanked with tapped ears on 2 3/4" centers	3.5	25
54 C 3 1	1"	Center blanked with tapped ears 2 3/4" centers	5.8	25
54 C 3 1 1/4	1 1/4"	Center blanked with tapped ears on 2 3/4" centers	7.3	25
54 C 14	5/8"	For single device	3.5	25
5401-LR	—	Flat, center blanked for single Receptacle — 1 1/2" dia. hole	—	25
5402 LR	—	Flat, center blanked for duplex receptacle	—	25

For swivel covers, see accessories section on page A-39.

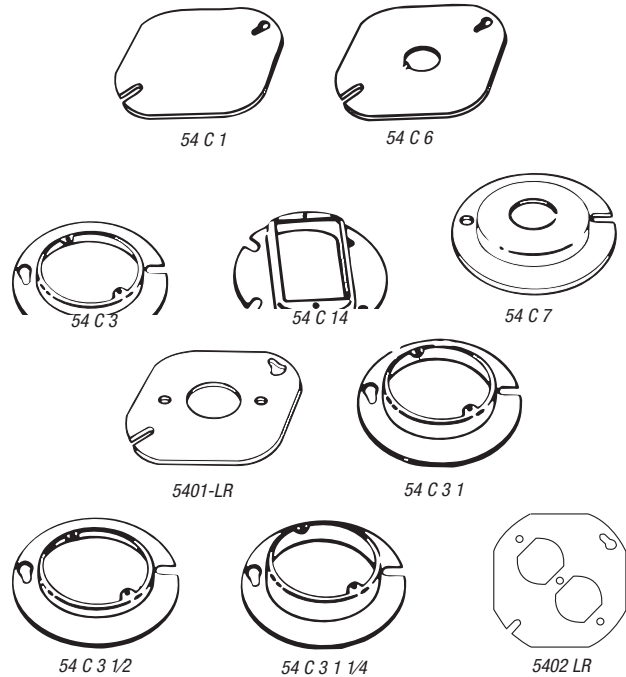

### 4" Octagon Box Extension Rings

CAT. NO.	KNOCKOUTS		STD. CTN.
	EA. SIDE CONDUIT	EA. END CONDUIT	
<b>1 1/2" Deep — with Conduit KOs — 15.8 Cubic Inch Capacity</b>			
551511/2-25	1-1/2"	1-1/2"	50
55151 1/2 3/4	1-1/2"	1-3/4"	25

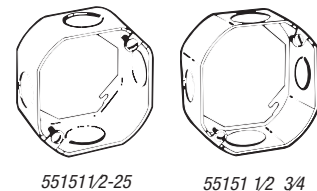

### Fan & Fixture Support

#### Steel and Non-Metallic Boxes and Bar Hangers for Fan and Fixture Installation

Exhaustive research and development has resulted in an innovative line of Ceiling Fan Support Boxes that give Thomas & Betts the competitive advantage. Ceiling fan and fixture installation is faster, easier and safer with Steel City® Ceiling Fan Support Boxes.

- Gold finish on ears/screws easily identifies boxes as meeting UL and NEC requirements for fan support
- UL Listed up to 50 lbs. for fixture and 35 lbs. for fan
- Each box comes complete with instructions and installation hardware

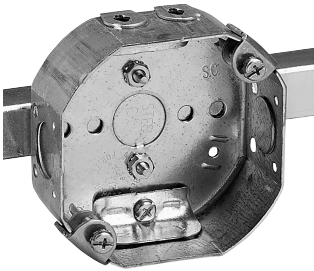
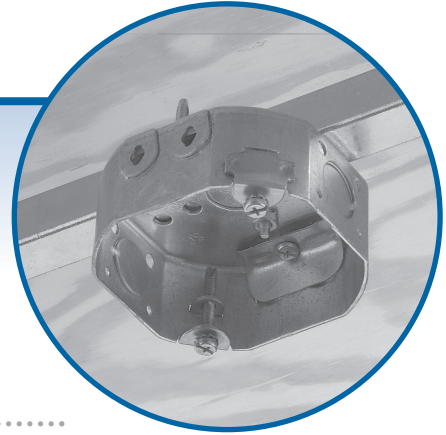

Intended for retrofit installations the unique design of the Old Work Bar Hanger ensures a trouble-free installation that surpasses the competition.

#### Ceiling Fan and Light Fixture Bar Hanger

- Square end plates keep the bar parallel with sheetrock
- Square section tube is easy to grip, allowing high torque for safe installation
- UL Listed up to 50 lbs. for fixture and 35 lbs. for fan
- Expandable for joists spaced from 16 to 24 inches



CAT. NO.	DESCRIPTION	CAPACITY CU. IN.	NEW/OLD WORK	STD. CTN.
54151CFB-BHL-OW	Old Work Bar Hanger with 1½" deep ceiling fan box with 3 x ½" KOs and clamps for non-metallic sheathed cable.	15.8	Old	10

Max. rec. loads 35 lbs. fan and 50 lbs. fixture.

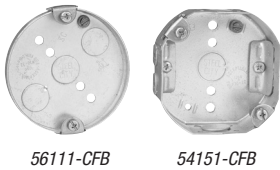

56111-CFB

54151-CFB

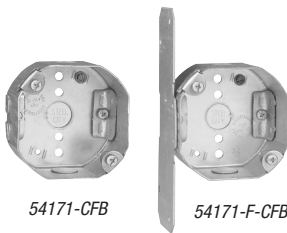

54171-CFB

54171-F-CFB

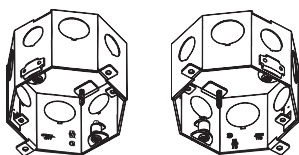

54551-CFB

54541-CFB

#### Ceiling Fan Support Boxes

CAT. NO.	DESCRIPTION	CAPACITY CU. IN.	DIMENSIONS		NEW/OLD WORK	STD. CTN.
			DIA.	DEPTH		
56111-CFB	Pan type ceiling fan box with 3 x ½" KOs and non-metallic sheathed cable connector	6.0	4"	½"	Both	10
54151-CFB	1½" deep ceiling fan box with 3 x ½" KOs and clamps for non-metallic sheathed cable	15.8	4"	1½"	New	10
54151-1/2-CFB-BP	1½" deep ceiling fan box with 5 x ½" KOs, bulk pack	15.8	4"	1½"	New	50
54171-CFB	2½" deep ceiling fan box with 3 x ½" KOs and clamps for non-metallic sheathed cable	22.0	4"	2½"	New	10
54171-F-CFB	As 54171-CFB, but with "F" style mounting bracket	22.0	4"	2½"	New	10
54171-1/2-F-CFB-BP	2½" deep ceiling fan box with 5 x ½" KOs and "F" style mounting bracket	22.0	4"	2½"	New	50

CAT. NO.	CLAMPS	EARS	BRKTS.	KNOCKOUTS			BOTTOM CONDUIT	STD. CTN.
				EA. SIDE CONDUIT	EA. END CONDUIT	EA. END CABLE		
54541-CFB	2½" DP	—	Concrete ring	½-¾"	—	—	—	50
54551-CFB	3" DP	—	Concrete ring	½-¾"	—	—	—	50

Max. rec. loads 35 lbs. fan and 50 lbs. fixture.

Cover — CBP, or CBP-3/8. 35# fan rating, 50# fixture rated.



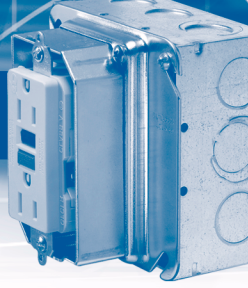

### Extra Heavy Duty New Work Bar Hangers

This innovative extruded aluminum bar hanger was designed for strength. It is UL Listed for up to 70 lbs. for fan support, and an industry leading 200 lbs. for fixture support

- Gold end plates easily identify the hanger as meeting UL and NEC requirements for fan support
- Screwed-on end plates are consistently strong and avoid unsightly welds
- End plates feature temporary fixing spikes for hands-free installation
- Expandable for joists spaced from 16 to 24 inches



### Ceiling Fan and Light Fixture Bar Hangers



CAT. NO.	DESCRIPTION	CAPACITY CU. IN.	MAX. REC. LOAD FAN	MAX. REC. LOAD FIXTURE	NEW/OLD WORK	STD. CTN.
56111CFB-BHL	New work bar hanger with ½" pan type ceiling fan box with 3 x ½" KOs and non-metallic sheathed cable connector.	6.0	70 lbs.	200 lbs.	New	10
54151CFB-BHL	New work bar hanger with 1½" deep ceiling fan box with 3 x ½" KOs and clamps for non-metallic sheathed cable.	15.8	70 lbs.	200 lbs.	New	10
4070CFB-BHL	New work bar hanger with non-metallic ceiling fan box with clamps for non-metallic sheathed cable.	21.5	35 lbs.	50 lbs.	New	10
CFB-BHL	New work bar hanger without—outlet box. Mounting bracket for outlet box included.		*	*	New	10

\* Dependent on box used.

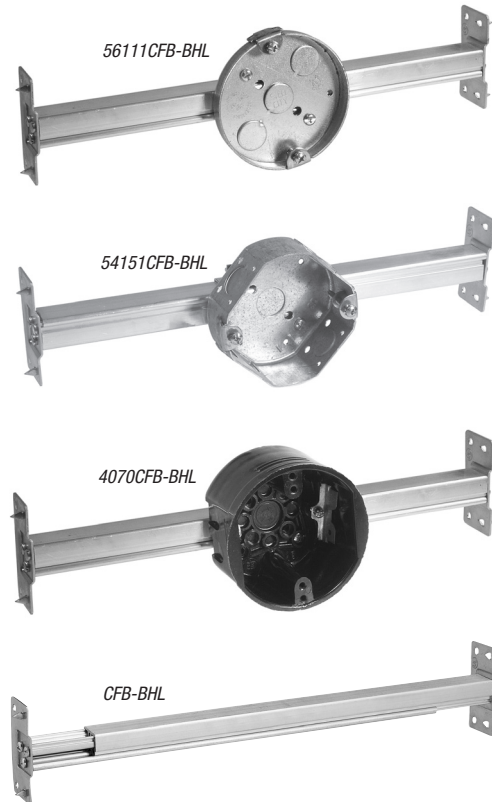

Steel City® Metallic Boxes and Covers

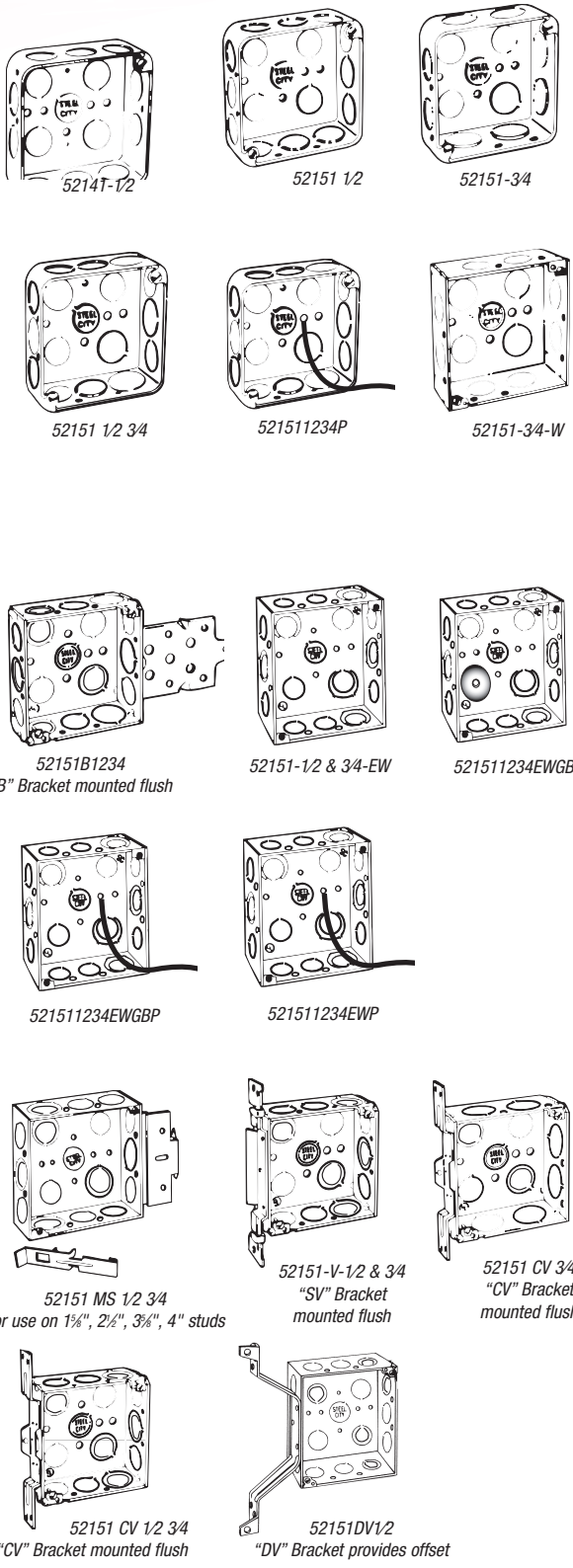

### 4" Square Boxes

CAT. NO.	BRKTS.	KNOCKOUTS			STD. CTN.
		EA. SIDE CONDUIT	EA. END CONDUIT	BOTTOM CONDUIT	
<b>1 1/4" Deep — with Conduit KOs — 18.0 Cubic Inch Capacity</b>					
52141-1/2	—	2-1/2"	3-1/2"	5-1/2"	50
<b>1 1/2" Deep — with Conduit KOs — 21.0 Cubic Inch Capacity Drawn</b>					
52151 1/2	—	3-1/2"	3-1/2"	5-1/2"	50
52151-3/4	—	2-3/4"	2-3/4"	3-1/2"	50
52151 1/2 3/4	—	2-1/2"	2-1/2"	3-1/2"	50
521511234P	—	2-1/2"	2-1/2"	3-1/2"	50
52151-3/4-W	—	2-3/4"	2-3/4"	3-1/2"	50
52151B1234*	B	2-1/2" 1-1/2" & 3/4"E	2-1/2" 1-3/4" & 3/4"E	3-1/2" 2-1/2" & 3/4"E	25
52151-1/2 & 3/4-EW	—	2-1/2" 1-1/2" & 3/4"E	2-1/2" 1-1/2" & 3/4"E	3-1/2" 2-1/2" & 3/4"E	50
521511234EWGB (Ground bump)	—	2-1/2" 1-1/2" & 3/4"E	2-1/2" 1-1/2" & 3/4"E	2-1/2" 2-1/2" & 3/4"E	50
521511234EWGBP (Ground bump with 10 1/2" ground wire)	—	2-1/2" 1-1/2" & 3/4"E	2-1/2" 1-1/2" & 3/4"E	2-1/2" 2-1/2" & 3/4"E	50
521511234EWP*	—	2-1/2" 1-1/2" & 3/4"E	2-1/2" 1-1/2" & 3/4"E	3-1/2" 2-1/2" & 3/4"E	50
52151 MS 1/2 3/4*	MS	2-1/2" 1-1/2" & 3/4"E	2-1/2" 1-3/4" & 3/4"E	3-1/2" 2-1/2" & 3/4"E	25
52151-V-1/2 & 3/4*	SV	2-1/2" 1-1/2" & 3/4"E	2-1/2" 1-3/4" & 3/4"E	3-1/2" 2-1/2" & 3/4"E	25
52151 CV 3/4*	CV	2-3/4" 2-1/2" 1-1/2" & 3/4"E	2-3/4" 2-1/2" 1-3/4" & 3/4"E	3-1/2" 3-1/2" 2-1/2" & 3/4"E	25
52151 DV12*	DV	2-1/2" & 3/4"E	3-1/2" & 3/4"E	3-1/2" & 3/4"E	25

\* All Bracketed boxes come complete with eccentric knockouts.

Per U.L. 514-A, suitable for use without a bonding jumper in circuits above or below 250 volts. Pigtail wire is #12 AWG insulated, 10 1/2" long.

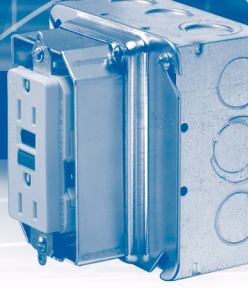

### 4" Square Boxes (continued)

CAT. NO.	CLAMPS	BRKTS.	KNOCKOUTS			STD. CTN.
			EA. SIDE CONDUIT	EA. END CONDUIT	BOTTOM CONDUIT	
<b>1½" Deep — with Non-Metallic Sheathed Cable Clamps — 21.0 Cubic Inch Capacity</b>						
52151 N	C-5	—	2-½" 1-½" & ¾"E	2	1-½"	50
52151 MS N*	C-5	MS	2-½" 1-½" & ¾"E	2	1-½"	25
52151 BN*	C-5	B	2-½" 1-½" & ¾"E	2	1-½"	25
52151 VN*	C-5	SV	2-½" 1-½" & ¾"E	2	1-½"	25
52151 CVN*	C-5	CV	2-½" 1-½" & ¾"E	2	1-½"	25
52151CVNP*	C-5	CV	2-½" 1-½" & ¾"E	2	1-½"	25

### 1½" Deep — with Armored Cable/Metal Clad Clamps — 21.0 Cubic Inch Capacity

52151 X	C-3	—	2-½" 1-½" & ¾"E	2	1-½"	50
52151XP	C-3	—	2-½" 1-½" & ¾"E	2	1-½"	50
52151 BX*	C-3	B	2-½" 1-½" & ¾"E	2	1-½"	25
52151 VX*	C-3	SV	2-½" 1-½" & ¾"E	2	1-½"	25
52151 CVX*	C-3	CV	2-½" 1-½" & ¾"E	2	1-½"	25
52151 MS X*	C-3	MS	2-½" 1-½" & ¾"E	2	1-½"	25

\* All Bracketed Boxes come complete with eccentric knockouts.

Per U.L. 514-A, suitable for use without a bonding jumper in circuits above or below 250 volts. Pigtail wire is #12 AWG insulated, 10½" long..

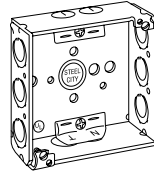

52151 N

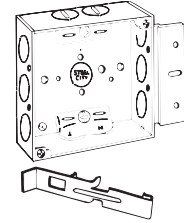

52151 MS N\* "MS" bracket for 1½", 2¼", 3½", 4"

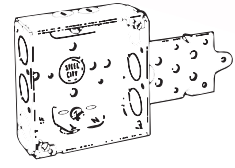

52151 BN\* "B" bracket mounted flush

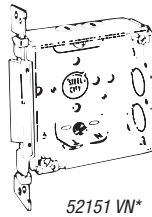

52151 VN\* "SV" bracket mounted flush

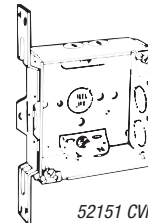

52151 CVN\* "CV" bracket mounted flush

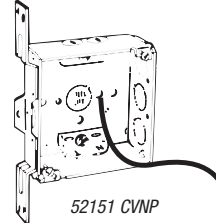

52151 CVNP

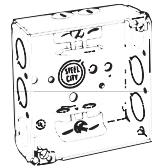

52151 X

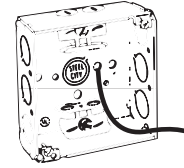

52151 XP

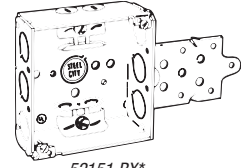

52151 BX\* "B" bracket mounted flush

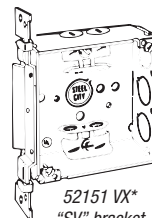

52151 VX\* "SV" bracket mounted flush

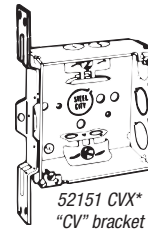

52151 CVX\* "CV" bracket mounted flush

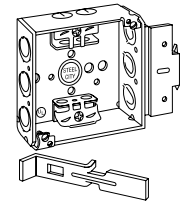

52151 MS X\* "MS" bracket for 1½", 2¼", 3½", 4" metal studs



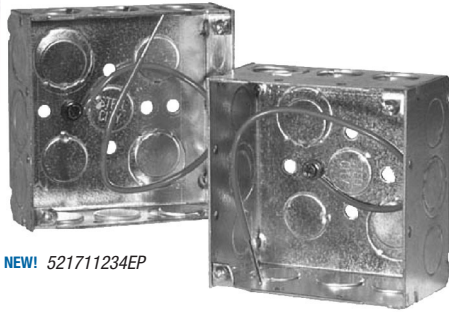

NEW! 521711234EP



52171 N

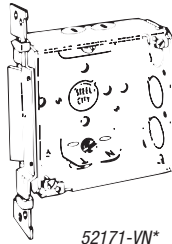

52171-VN\*

"SV" bracket mounted flush

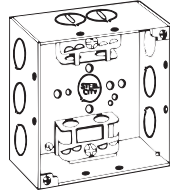

52171 X

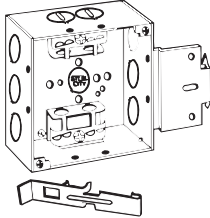

52171 MSX\*

"MS" bracket for 1½", 2½", 3½", 4" metal studs

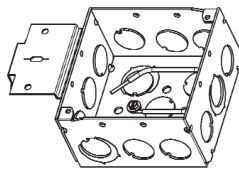

52171 MSXP\*

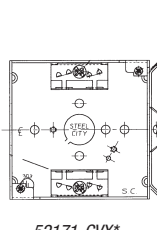

52171-CVX\*

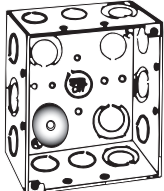

521711234E

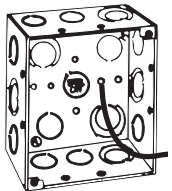

521711234EP

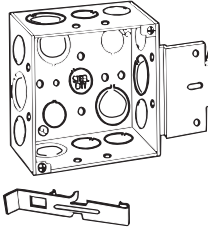

52171 MS 1/2 3/4\*

"MS" bracket for 1½", 2½", 3½", 4", 6" metal studs

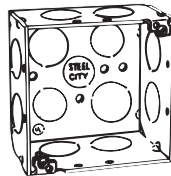

52171 3/4

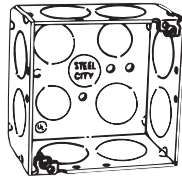

52171 1

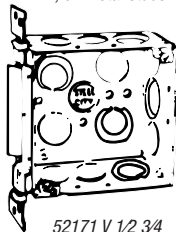

52171 V 1/2 3/4\*

"SV" bracket mounted flush

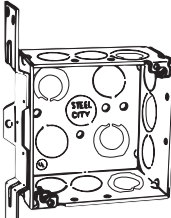

52171-CV-1/2 & 3/4

"CV" bracket mounted flush

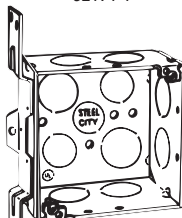

52171-CV-3/4

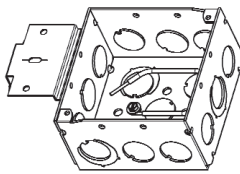

52171MSP

### 4" Square Boxes (continued)

CAT. NO.	CLAMPS	BRKTS.	KNOCKOUTS			STD. CTN.
			EA. SIDE CONDUIT	EA. END CABLE	BOTTOM CONDUIT	
<b>2½" Deep — with Non-Metallic Sheathed Cable Clamps — 30.3 Cubic Inch Capacity</b>						
52171 N	C-5	—	2-½" 1-½" & ¾"E	2	1-½"	25
52171-VN*	C-5	SV	2-½" 1-½" & ¾"E	2	1-½"	25
<b>2½" Deep — for Armored Cable and Metal Clad Cable Clamps — 30.3 Cubic Inch Capacity</b>						
52171 X*	C-3	—	2-½" 1-½" & ¾"E	2	1-½"	25
52171 MSX*	C-3	MS	2-½" 1-½" & ¾"E	2	1-½"	25
52171 MSXP (With 10½" ground wire)	C-3	MS	2-½" 1-½" & ¾"E	2	1-½"	25
52171-CVX*	C-3	CV-2	½ -¾"	—	—	25
<b>2½" Deep — with Conduit KOs — 30.3 Cubic Inch Capacity</b>						
521711234E	—	—	2-½" 1-½" & ¾"E	2-½" 1-½" & ¾"E	3-½" 2-½" & ¾"E	50
521711234EP (With 10½" ground wire)	—	—	2-½" 1-½" & ¾"E	2-½" 1-½" & ¾"E	2-½" 2-½" & ¾"E	50
52171 MS 1/2 3/4*	—	MS	2-½" 1-½" & ¾"E	2-½" 1-½" & ¾"E	3-½" 2-½" & ¾"E	25
52171 MSP* (With 10½" ground wire)	—	MS	2-½" 1-½" & ¾"E	2-½" 1-½" & ¾"E	3-½" 2-½" & ¾"E	25
<b>2½" Deep — with Conduit KOs — 30.3 Cubic Inch Capacity</b>						
52171 3/4	—	—	2-¾" 2-1"	2-¾" 2-1"	3-½", 2-¾"	50
52171 1	—	—	2-1" 2-½"	2-1" 2-½"	3-½", 2-¾"	50
52171 V 1/2 3/4*	—	SV	2-½" 1-½", & ¾"E	2-½" 1-½", & ¾"E	3-½" 2-½", & ¾"E	25
52171-CV-1/2 & 3/4*	—	CV	2-½" 1-½", & ¾"E	2-½" 1-½", & ¾"E	3-½" 2-½", & ¾"E	25
52171-EW-SSX*	—	SSX	—	—	—	—
521711234EP*	—	v	2-½" 1-½", & ¾"E	2-½" 1-½", & ¾"E	3-½" 2-½", & ¾"E	25
52171-B-1/2 & 3/4	—	—	2-½" 1-½", & ¾"E	2-½" 1-½", & ¾"E	3-½" 2-½", & ¾"E	25

\* All Bracketed Boxes come complete with eccentric knockouts.

Per UL 514-A, suitable for use without a bonding jumper in circuits above or below 250 volts.

Pigtail wire is #12 AWG insulated, 10½" long.

All 52171 series boxes have a raised ground bump.

\* All bracketed boxes come complete with eccentric knockouts.

Per UL 514-A, suitable for use without a bonding jumper in circuits above or below 250 volts.

Pigtail wire is #12 AWG insulated, 10½" long.

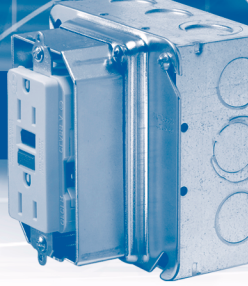

### 4" Square Two-Device Boxes

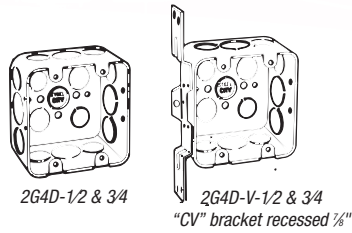

2G4D-1/2 & 3/4

2G4D-V-1/2 & 3/4  
"CV" bracket recessed 1/8"

CAT. NO.	BRACKETS	KNOCKOUTS			STD. CTN.
		EA. SIDE CONDUIT	EA. END CONDUIT	BOTTOM CONDUIT	
<b>2 1/8" Deep — with Conduit KOs — 30.3 Cubic Inch Capacity</b>					
2G4D 1/2 3/4	—	2-1/2", 1-3/4"	2-1/2", 1-3/4"	3-1/2", 2-3/4"	25
2G4DV 1/2 3/4	CV	2-1/2", 1-3/4"	2-1/2", 1-3/4"	3-1/2", 2-3/4"	25

### 4" Square Thru-Wall Box



X1-1/2 3/4

CAT. NO.	KNOCKOUT		STD. CTN.
	EA. SIDE CONDUIT	EA. END CONDUIT	
<b>1 1/8" Deep — with Conduit KOs — 21.0 Cubic Inch Capacity</b>			
X1-1/2 3/4	2-1/2", 1-3/4"	2-1/2", 1-3/4"	25

### 4" Square Extension Rings

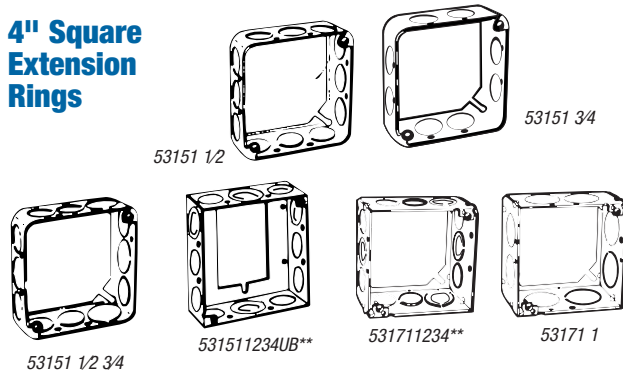

53151 1/2

53151 3/4

53151 1/2 3/4

531511234UB\*\*

531711234\*\*

53171 1

CAT. NO.	KNOCKOUTS		STD. CTN.
	EA. SIDE CONDUIT	EA. END CONDUIT	
<b>1 1/2" Deep — with Conduit KOs — 21.0 Cubic Inch Capacity</b>			
53151 1/2	3-1/2"	3-1/2"	50
53151 3/4	2-3/4"	2-3/4"	25
53151 1/2 3/4	2-1/2"	2-1/2"	50
531511234UB**	1-3/4"	1-3/4"	50
	2-1/2"	2-1/2"	
<b>1 1/8" Deep — with Conduit KOs — 30.3 Cubic Inch Capacity</b>			
531711234*	2-1/2"	2-1/2"	25
53171 1	1-1/2" & 3/4"E	1-3/4"	25
	2-1"	2-1"	

\* Per U.L. 514-A, suitable for use without a bonding jumper in circuits above or below 250 volts.

\*\* ECC, KOs on sides.

### 4" Square Box Partitions

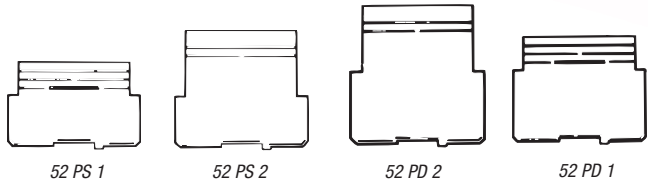

CAT. NO.	DESCRIPTION	STD. CTN.
<b>For 1 1/2" Deep Box with Square Cut Tile Wall Two-Device Covers</b>		
52 PS 1	For 1/2", 3/4" and 1" raised covers	25
52 PS 2	For 1/4", 1 1/2" and 2" raised covers	25
<b>For 2 1/8" Deep Box with Square Cut Tile Wall Two-Device Covers</b>		
52 PD 1	For 1/2", 3/4" and 1" raised covers	25
52 PD 2	For 1/4", 1 1/2" and 2" raised covers	25

### 3 and 4 Gang Draw-Style Device Boxes

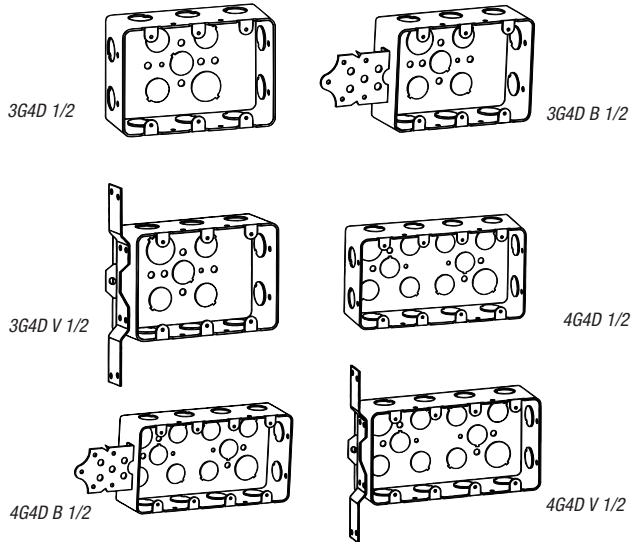

CAT. NO.	BRACKETS	EA. SIDE CONDUIT	EA. END CONDUIT	STD. CTN.
<b>2 1/8" Deep — 3 Gang — 44.3 Cubic Inch, 4 Gang — 58.0 Cubic Inch</b>				
3G4D 1/2	—	3-1/2"	2-1/2"	20
3G4D B 1/2	B	3-1/2"	2-1/2"	20
3G4D V 1/2	CV	3-1/2"	2-1/2"	20
4G4D 1/2	—	4-1/2"	2-1/2"	20
4G4D B 1/2	B	4-1/2"	2-1/2"	20
4G4D V 1/2	CV	4-1/2"	2-1/2"	20

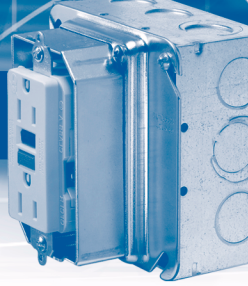

### 4" Square Two-Device Boxes

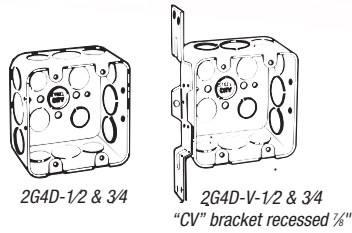

2G4D-1/2 & 3/4

2G4D-V-1/2 & 3/4  
"CV" bracket recessed 1/4"

CAT. NO.	BRACKETS	KNOCKOUTS			STD. CTN.
		EA. SIDE CONDUIT	EA. END CONDUIT	BOTTOM CONDUIT	
<b>2 1/8" Deep — with Conduit KOs — 30.3 Cubic Inch Capacity</b>					
2G4D 1/2 3/4	—	2-1/2", 1-3/4"	2-1/2", 1-3/4"	3-1/2", 2-3/4"	25
2G4DV 1/2 3/4	CV	2-1/2", 1-3/4"	2-1/2", 1-3/4"	3-1/2", 2-3/4"	25

### 4" Square Thru-Wall Box



X1-1/2 3/4

CAT. NO.	KNOCKOUT		STD. CTN.
	EA. SIDE CONDUIT	EA. END CONDUIT	
<b>1 1/8" Deep — with Conduit KOs — 21.0 Cubic Inch Capacity</b>			
X1-1/2 3/4	2-1/2", 1-3/4"	2-1/2", 1-3/4"	25

### 4" Square Extension Rings

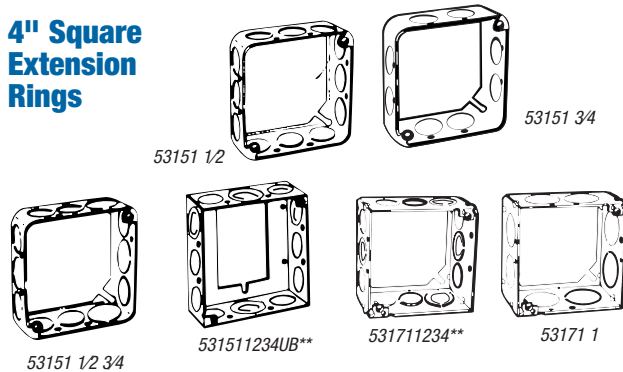

53151 1/2

53151 3/4

53151 1/2 3/4

531511234UB\*\*

531711234\*\*

53171 1

CAT. NO.	KNOCKOUTS		STD. CTN.
	EA. SIDE CONDUIT	EA. END CONDUIT	
<b>1 1/2" Deep — with Conduit KOs — 21.0 Cubic Inch Capacity</b>			
53151 1/2	3-1/2"	3-1/2"	50
53151 3/4	2-3/4"	2-3/4"	25
53151 1/2 3/4	2-1/2"	2-1/2"	50
531511234UB**	1-3/4"	1-3/4"	50
	2-1/2"	2-1/2"	
<b>1 1/8" Deep — with Conduit KOs — 30.3 Cubic Inch Capacity</b>			
531711234*	2-1/2"	2-1/2"	25
53171 1	1-1/2" & 3/4"E	1-3/4"	25
	2-1"	2-1"	

\* Per U.L. 514-A, suitable for use without a bonding jumper in circuits above or below 250 volts.

\*\* ECC, KOs on sides.

### 4" Square Box Partitions

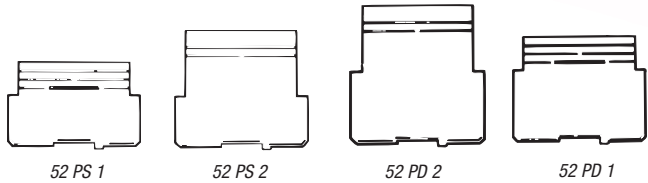

52 PS 1

52 PS 2

52 PD 2

52 PD 1

CAT. NO.	DESCRIPTION	STD. CTN.
<b>For 1 1/2" Deep Box with Square Cut Tile Wall Two-Device Covers</b>		
52 PS 1	For 1/2", 3/4" and 1" raised covers	25
52 PS 2	For 1/4", 1 1/2" and 2" raised covers	25
<b>For 2 1/8" Deep Box with Square Cut Tile Wall Two-Device Covers</b>		
52 PD 1	For 1/2", 3/4" and 1" raised covers	25
52 PD 2	For 1/4", 1 1/2" and 2" raised covers	25

### 3 and 4 Gang Draw-Style Device Boxes

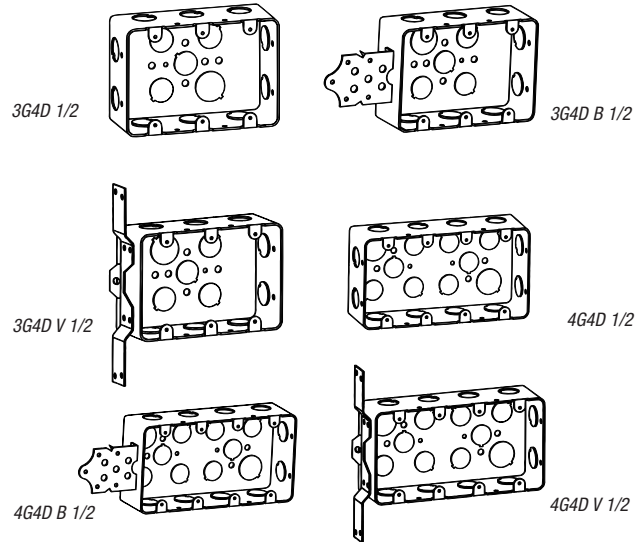

3G4D 1/2

3G4D B 1/2

3G4D V 1/2

4G4D 1/2

4G4D B 1/2

4G4D V 1/2

CAT. NO.	BRACKETS	EA. SIDE CONDUIT	EA. END CONDUIT	STD. CTN.
<b>2 1/8" Deep — 3 Gang — 44.3 Cubic Inch, 4 Gang — 58.0 Cubic Inch</b>				
3G4D 1/2	—	3-1/2"	2-1/2"	20
3G4D B 1/2	B	3-1/2"	2-1/2"	20
3G4D V 1/2	CV	3-1/2"	2-1/2"	20
4G4D 1/2	—	4-1/2"	2-1/2"	20
4G4D B 1/2	B	4-1/2"	2-1/2"	20
4G4D V 1/2	CV	4-1/2"	2-1/2"	20





# Steel City®

## Square Boxes and Accessories

Steel City® Metallic Boxes and Covers

### 4" Square Covers

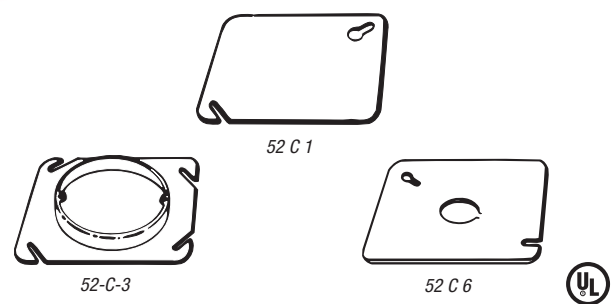

CAT. NO.	RAISED	DESCRIPTION	CU. IN. CAP.	STD. CTN.
52 C 1	—	Flat, blank	—	100
52-C-3-25	5/8"	Center blanked with tapped ears on 2 3/4" centers	4.3	25
52-C-3-1/2-25	1/2"	Center blanked with tapped ears on 2 3/4" centers	3.5	25
52-C-3-3/4	3/4"	Center blanked with tapped ears on 2 3/4" centers	4.3	25
52 C 3 1	1"	Center blanked with tapped ears on 2 3/4" centers	5.8	25
52-C-3-1-1/4	1 1/4"	Center blanked with tapped ears on 2 3/4" centers	7.3	25
52 C 6	—	Flat, with 1/2" KO	—	100

### 4" Square Cut Tile Wall Covers

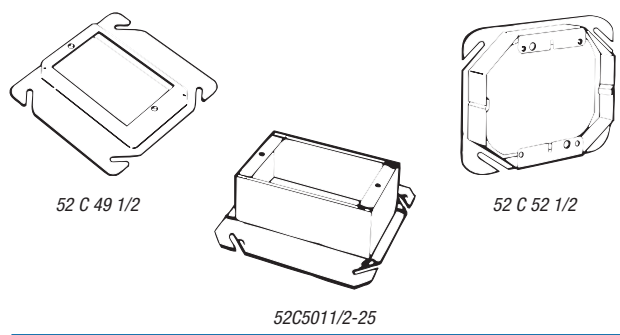

CAT. NO.	RAISED	DESCRIPTION	CU. IN. CAP.	STD. CTN.
<b>For Single Device — Steel</b>				
52 C 49 1/2*	1/2"	—	3.5	50
52-C-49-3/4*	3/4"	—	5.3	50
52-C-49-1*	1"	—	7.0	10
52-C-49-1-1/4	1 1/4"	—	9.3	10
52C5011/2-25	1 1/2"	—	11.0	25
52C512-25	2"	—	14.8	25
<b>For Two Devices — Steel</b>				
52 C 52 1/2	1/2"	Square corners facilitate tile installation	6.0	10
52-C-52-3/4	3/4"		9.0	10
52-C-52-1	1"		12.5	10
52-C-52-1-1/4	1 1/4"		15.5	10
52 C 53 1 1/2	1 1/2"		19.0	10
52 C 54 2	2 3/4"		25.5	10

\* Drawn style.

### 4" Square Device Covers

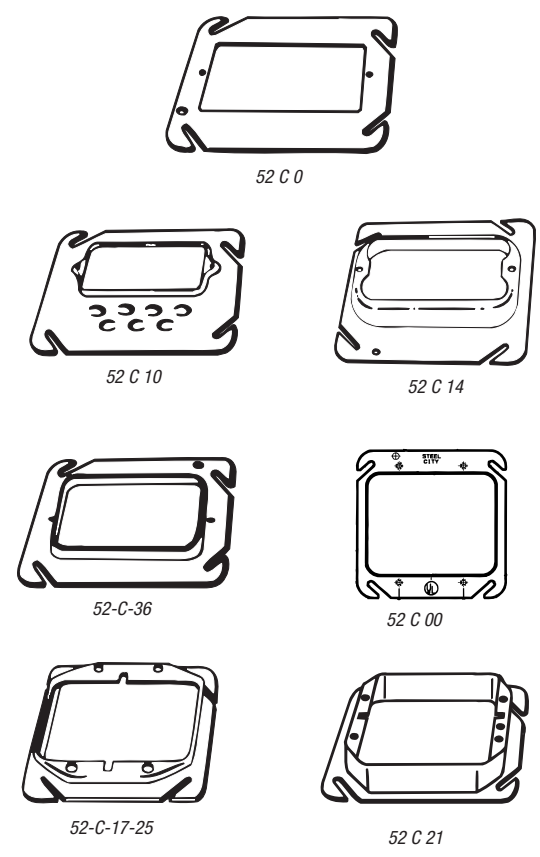

CAT. NO.	RAISED	DESCRIPTION	CU. IN. CAP.	STD. CTN.
<b>For Single Device — Steel</b>				
52 C 0	—	Flat	—	25
52 C 62	1/4"	Keyed for plaster	1.5	25
52 C 10	1/4"	Offset, keyed for plaster	1.0	25
52 C 13	1/2"	—	3.0	50
52 C 14	3/4"	—	5.0	50
52 C 14 5/8	5/8"	—	4.0	50
52 C 15	1"	—	7.0	25
52 C 16	1 1/4"	—	8.3	25
52-C-36	1/4"	For dry wall construction	1.0	25
<b>For Two Devices</b>				
52 C 00	—	Flat	—	25
52C20-25	1/4"	—	2.3	25
52-C-17-25	1/2"	—	6.3	25
52 C 18	3/4"	—	9.0	25
52-C-18-5/8-25	5/8"	For dry wall construction	7.3	25
52 C 19	1"	—	12.0	25
52 C 21	1 1/4"	—	15.0	25
52 C 37	1/8"	—	2.3	25

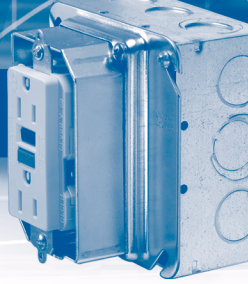

### Box Support Covers

Steel City® Box Support covers combine a box-to-stud mounting bracket with a device cover in one, easy-to-use product. Designed for use with 4" square boxes, Steel City® Box Support Covers can be used with both steel and wood studs.

- Combines cover and bracket in one component
- Available in one and two device versions
- 1/2", 5/8" and 3/4" raised covers
- Speeds installation time
- Needs no far side support
- Can be used with both steel and wood stud
- Can be used without a box as a low voltage device support
- UL and CSA Listed. UL File #E2969. CSA File #LR5043



CAT. NO.	RAISED	# OF DEVICES	CU. IN. CAP.	STD. CTN.
<i>1/2", 5/8" and 3/4" Raised Covers for Single or Two Devices.</i>				
52CM13	1/2"	1	3.0	25
52CM14-5/8	5/8"	1	4.0	25
52CM14	3/4"	1	5.0	25
<i>Two Device</i>				
52CMD17	1/2"	2	6.3	25
52CMD18-5/8	5/8"	2	7.3	25
52CMD18	3/4"	2	9.0	25

### 4" Square Surface Covers

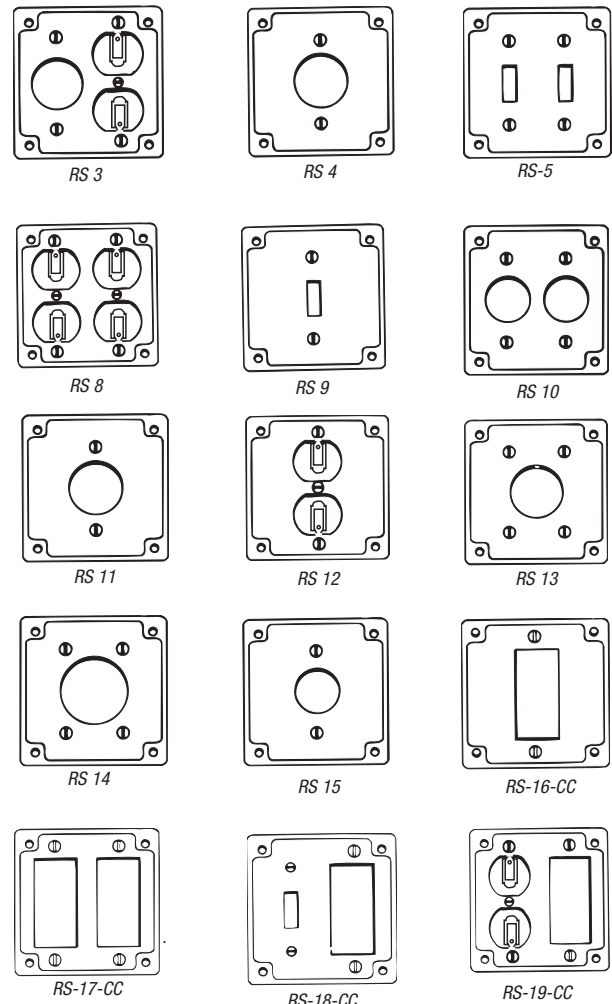
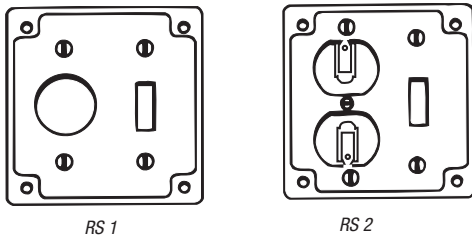

CAT. NO.	DIA. HOLE (IN.)	DESCRIPTION	STD. CTN.
<i>1/2" Deep — 5.0 Cubic Inch Capacity</i>			
RS 1	1 13/32"	For one toggle switch and one single flush receptacle	50
RS 2*	—	For one toggle switch and one duplex flush receptacle	50
RS 3*	1 13/32"	For one single and one duplex flush receptacle	50
RS 4	1 19/65"	For one 4-wire twist-lock single receptacle	50
RS 5	—	For two toggle switches	50
RS 8*	—	For two duplex, flush receptacles	50
RS 9	—	For one toggle switch	50
RS 10	1 13/32"	For two single, flush receptacles	50
RS 11	1 13/32"	For one single, flush receptacle	50
RS 12*	—	For one duplex, flush receptacle	50
RS 13	25/32"	For one 30 or 50 amp. dryer or range receptacle	50
RS 14	2 15/32"	—	50
RS 15	1 1/4"	For #3330-30A 250 V twist-lock receptacle	50
RS-16-CC	—	For one ground fault receptacle	25
RS-17-CC	—	For two ground fault receptacles	25
RS-18-CC	—	For one ground fault receptacle and one toggle switch	25
RS-19-CC*	—	For one ground fault receptacle and one duplex receptacle	25

Remove portion of G.F.I. receptacle ear to mount receptacle to cover.

Screws captivated.

\* Now manufactured to meet new code C4 and to conform to the 1996 N.E.C. change.

# Steel City®

## Square Boxes and Accessories

Finally a quick, easy solution for a common rough-in problem!

### Steel City® Adjustable Mud Ring

**NEW!**

Now there's a quick, easy and economical way to ensure that stud-mounted outlet boxes fit flush with finished drywall, plaster or ceramic tile. The Steel City® Adjustable Mud Ring features an inner ring that adjusts from ½" to 1½" in depth to accommodate various drywall thicknesses. Marked with a measured rule and equipped with two adjustment screws, the inner ring can be set to the anticipated depth prior to installation and then easily adjusted after drywall installation to accommodate any variation in depth (½ to 1½). Rely on the Steel City® Adjustable Mud Ring for a code-compliant finish in many applications.

#### Typical Applications:

- Outside firewalls in hotel, casino and residential high-rise structures
- Hospital construction, where drywall depth often varies
- Ceramic-tile walls
- Any other application in which a stud-mounted box and mud ring may require depth adjustment prior to final trim

#### Adjustability Enables Flush Fit with Drywall Every Time!

- Patent-pending design, rugged steel construction similar to standard mud ring but with greater flexibility
- Quick-release locking mechanism enables fast and easy adjustment of inner ring
- Locking mechanism located behind outer ring remains safe from router damage or excess mudding
- Adjustment screws located outside inner ring leaves maximum capacity for devices — won't take up crucial box area
- Measured rule on inner ring
- Mounts to any standard 4"-square 2½" deep outlet box such as Steel City® 521711234E
- Accepts industry standard devices, including GFCIs
- UL Listed component

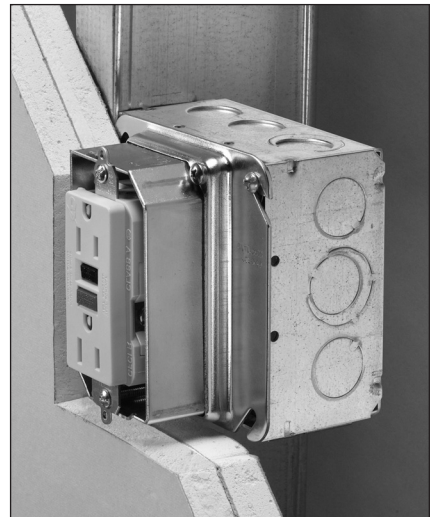

### Steel City® Adjustable Mud Ring



CAT. NO.	DESCRIPTION	STD. CTN.
52-C-ADJ	Single-gang adjustable Mud Ring, ½" to 1½"	25



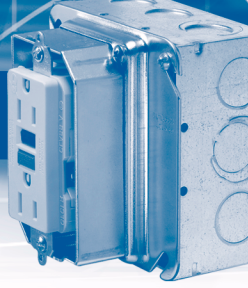

### Steel City® Adjustable Mud Ring (continued)

2 adjustment screws in opposing corners

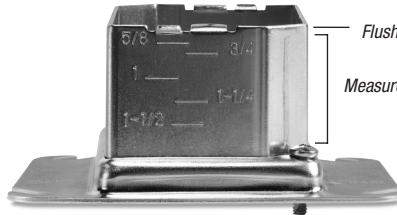

### Adjustable Mud Ring Installation/Adjustment Steps

#### Rough-In Phase:

Install mud ring to box with the inner ring in the extended position.

Set the depth of the inner ring to the anticipated drywall/tile thickness and lock into place by tightening adjustment screws.

**NOTE:** Mud ring is shipped assembled with the inner ring not preset

#### Problem: Ring is set too far back/forward

##### Solution:

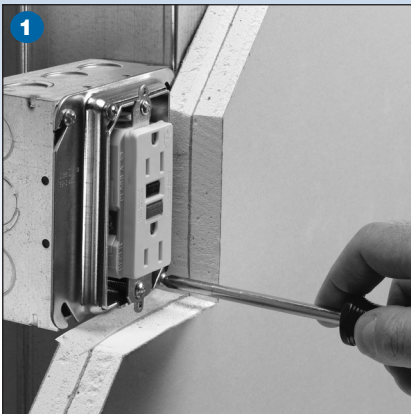

#### Loosen...

The 2 adjustment screws located in opposing corners of the mud ring.

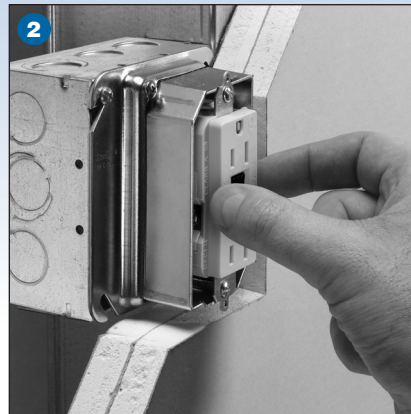

#### Adjust...

Inner ring to be flush with wall surface.

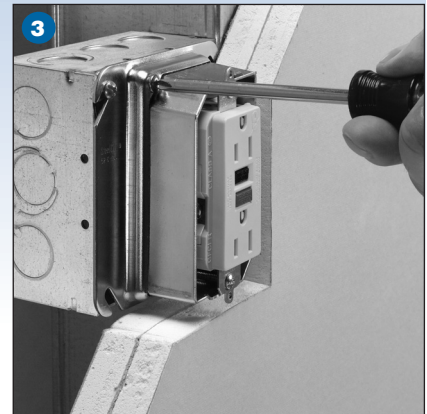

#### Re-tighten...

Adjustment screws.

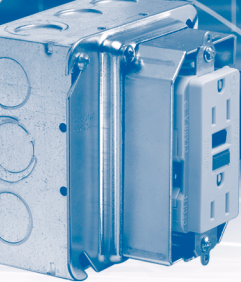

# Steel City®

## Square Boxes and Accessories

Steel City® Metallic Boxes and Covers

### Steel City® Hands-Free Swivel Hanger

The new Steel City® Hands-Free Swivel Hanger allows you to quickly install high and low bay lighting fixtures without the need for an extra set of hands. The patented hanger design allows the fixture to be set in place, giving users access to the conductors while wiring is being completed. The Hands-Free Swivel Hanger can support a fixture up to 50 pounds and is ideal for gyms or other commercial sites.

- Fits standard 3½" or 4" octagon (SHHFR1234)
- Fits 4" square (SHHF1234) boxes
- A single installer can complete the installation — saving time, labor and cost
- Fixtures can be set in place before wiring is completed
- Patented design allows users to access the conductors after the fixture has been mounted onto the box
- Accommodates ½" or ¾" threaded fixture pipes
- Permits 20° swing from vertical
- Ideal for gyms or other commercial sites

**Material:** Zinc plated sheet metal hanger and malleable iron swivel connector.  
**Listing:** UL, CSA Listed.

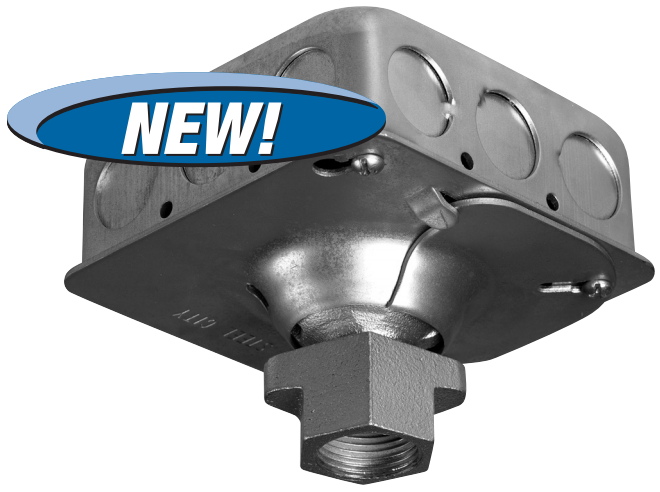

CAT. NO.	DESCRIPTION	STD. CTN.
SHHF 1/2 3/4	Hands-free Swivel Hanger	25
SHHFR 1/2 3/4	Hands-free Swivel Hanger (round)	25

### Swivel Hangers

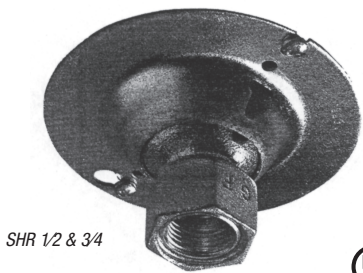

SHR 1/2 & 3/4



CAT. NO.	DESCRIPTION	STD. CTN.
SHR 1/2 & 3/4	Swivel hanger for 4" octagonal boxes	25

UL Listed for 50 lb. Fixture Support.

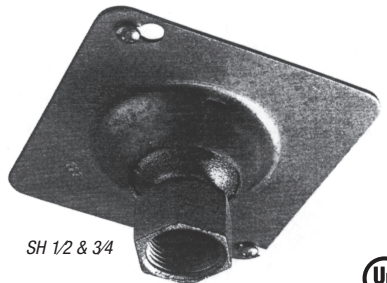

SH 1/2 & 3/4



CAT. NO.	DESCRIPTION	STD. CTN.
SH 1/2 & 3/4	Swivel hanger for 4" square boxes	25

UL Listed for 50 lb. Fixture Support.

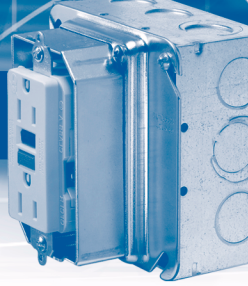

### 4<sup>1</sup>/<sub>16</sub>" Square Boxes

CAT. NO.	EA. SIDE CONDUIT	EA. END CONDUIT	BOTTOM CONDUIT	STD. CTN.
<b>1½" Deep — with Conduit KOs — 29.5 Cubic Inch Capacity</b>				
72151-1/2 & 3/4-E*	3-½" & ¾- <sup>33</sup> / <sub>64</sub> "	2-½" & ¾- <sup>33</sup> / <sub>64</sub> "	2-½" & ¾"-E 4-½"	20
<b>2½" Deep — with Conduit KOs — 42.0 Cubic Inch Capacity</b>				
72171 1	*2-1"	2-1"	3-½", 2-¾"	20
72171 3/4 1*	1-¾", 1-1"	1-¾", 1-1"	3-½", 3-¾", 2-1"	20
72171 1 1/4*	2-1¼"	1-1¼"	3-½", 2-¾"	20
72171CV 1/2 3/4*	2-½", 1-¾"	2-½", 1-¾"	3-½", 2-¾"	25
72151 MS 1/2 3/4*	3-½" & ¾- <sup>33</sup> / <sub>64</sub> "	3-½" & ¾- <sup>33</sup> / <sub>64</sub> "	E2-½" & ¾- <sup>33</sup> / <sub>64</sub> " 3-½"	20
72151 MS 1/2 3/4	3-½" & ¾- <sup>33</sup> / <sub>64</sub> "	2-½" & ¾- <sup>33</sup> / <sub>64</sub> "	2-½" & 2-¾- <sup>33</sup> / <sub>64</sub> " 4-½"	25
72171 MS 1/2 3/4*	3-½" & ¾- <sup>33</sup> / <sub>64</sub> "	3-½" & ¾- <sup>33</sup> / <sub>64</sub> "	2-½" & ¾- <sup>33</sup> / <sub>64</sub> " 3-½"	25
72151MSX	3-½" & ¾- <sup>33</sup> / <sub>64</sub> "	2-½" & ¾- <sup>33</sup> / <sub>64</sub> "	2-½" & 2-¾- <sup>33</sup> / <sub>64</sub> " 4-½"	25
72151MSXP	3-½" & ¾- <sup>33</sup> / <sub>64</sub> "	2-½" & ¾- <sup>33</sup> / <sub>64</sub> "	2-½" & 2-¾- <sup>33</sup> / <sub>64</sub> " 4-½"	25
72151MSP	3-½" & ¾- <sup>33</sup> / <sub>64</sub> "	3-½" & ¾- <sup>33</sup> / <sub>64</sub> "	3-½" & 2-½" ¾- <sup>33</sup> / <sub>64</sub> "	25
72171MSX	3-½" & ¾- <sup>33</sup> / <sub>64</sub> "	3-½" & ¾- <sup>33</sup> / <sub>64</sub> "	3-½" & 2-½" ¾- <sup>33</sup> / <sub>64</sub> "	25
72171MSXP	3-½" & ¾- <sup>33</sup> / <sub>64</sub> "	3-½" & ¾- <sup>33</sup> / <sub>64</sub> "	3-½" & 2-½" ¾- <sup>33</sup> / <sub>64</sub> "	25

\* Per UL 514-A, suitable for use without a bonding jumper in circuits above or below 250 volts.

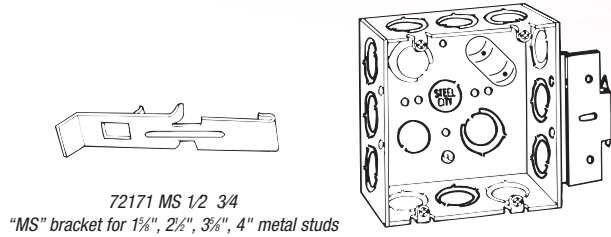

72171 MS 1/2 3/4  
"MS" bracket for 1½", 2½", 3½", 4" metal studs

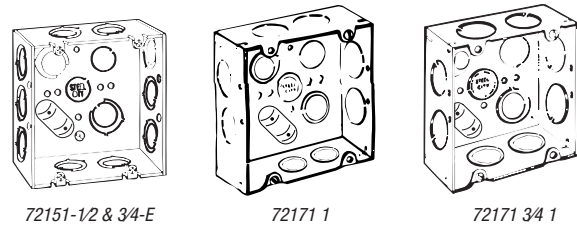

72151-1/2 & 3/4-E      72171 1      72171 3/4 1

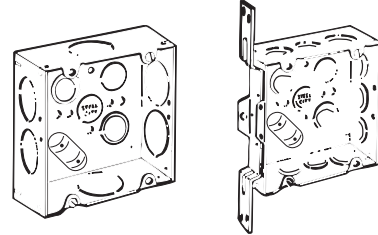

72171 1 1/4      72171CV 1/2 3/4

Steel City® Metallic Boxes and Covers

### 4<sup>1</sup>/<sub>16</sub>" Square Box Extension Rings

CAT. NO.	KNOCKOUT		STD. CTN.
	EA. SIDE CONDUIT	EA. END CONDUIT	
<b>1½" Deep — with Conduit KOs — 29.5 Cubic Inch Capacity</b>			
73151 1/2 3/4*	2-½" 1¼"	2-½" 1¼"	20
<b>2½" Deep — with Conduit KOs — 42.0 Cubic Inch Capacity</b>			
73171 1/2 3/4*	2-½" 1¾"	2-½" 1¾"	20
73171 1	2-1"	2-1"	20

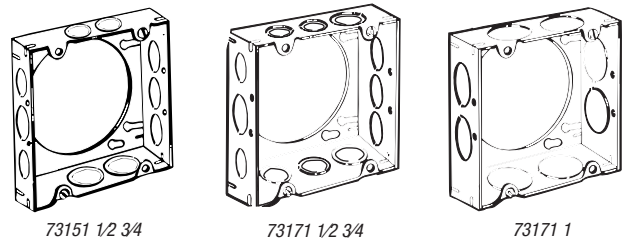

73151 1/2 3/4      73171 1/2 3/4      73171 1

### 4<sup>1</sup>/<sub>16</sub>" Square Covers

CAT. NO.	RAISED	DESCRIPTION	CU. IN. CAP.	STD. CTN.
72 C 1	—	Flat blank	—	50
72 C 6	—	Flat with ½" KO	—	25
72 C 3	⅝"	Center blanked with tapped ears on 2 <sup>29</sup> / <sub>32</sub> " centers	3.5	10
72-C-3-1/2	½"		3.0	25
72-C-3-3/4	¾"		4.3	10
72-C-3-1	1"		5.8	25

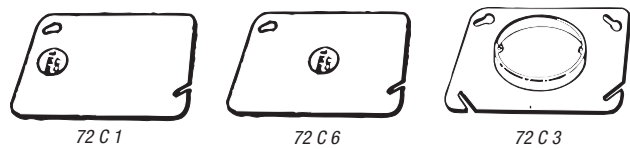

72 C 1      72 C 6      72 C 3



### 4<sup>1</sup>/<sub>16</sub>" Square Box Partitions

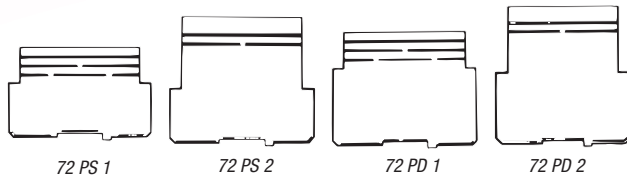

CAT. NO.	DESCRIPTION	STD. CTN.
<b>For 1<sup>1</sup>/<sub>2</sub>" Deep Box with Square Cut Tile Wall — Two-Device Covers</b>		
72 PS 1	For 1/2", 3/4" and 1" raised covers	25
72 PS 2	For 1 1/4", 1 1/2" and 2" raised covers	25
<b>For 2 1/8" Deep Box with Square Cut Tile Wall — Two-Device Covers</b>		
72 PD 1	For 1/2", 3/4" and 1" raised covers	25
72 PD 2	For 1 1/4", 1 1/2" and 2" raised covers	25

### 4<sup>1</sup>/<sub>16</sub>" Square Surface Covers

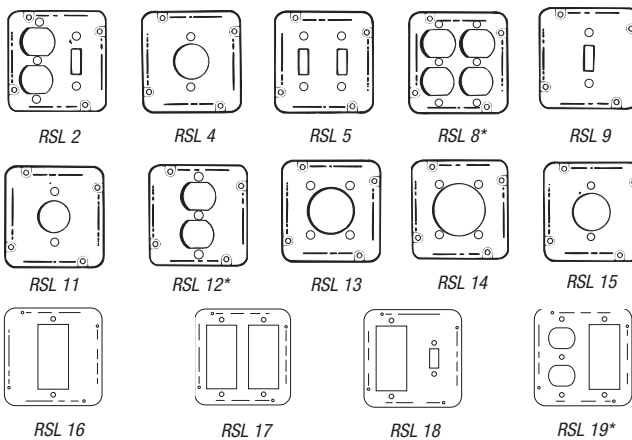

CAT. NO.	DIA. HOLE (IN.)	DESCRIPTION	STD. CTN.
<b>1/2" Deep — 7.5 Cubic Inch Capacity</b>			
RSL 2*	—	For one toggle switch and one duplex flush receptacle	10
RSL 4	1 1/32"	For one 4-wire twist-lock single receptacle	10
RSL 5	—	For two toggle switches	10
RSL 8*	—	For two duplex, flush receptacles	10
RSL 9	1 5/32"	For one toggle switch	10
RSL 11	1 55/64"	For one single, flush receptacle	10
RSL 12*	—	For one duplex, flush receptacle	10
RSL 13	2 3/32"	For one 30 to 50 amp. dryer or range receptacle	10
RSL 14	2 15/32"	—	10
RSL 15	1 3/4"	For #3330–30A 250 V twist-lock receptacle	10
RSL 16	—	For one ground fault receptacle	10
RSL 17	—	For two ground fault receptacles	10
RSL 18	—	For one ground fault receptacle and one toggle switch	10
RSL 19*	—	For one ground fault receptacle and one duplex receptacle	10

\* Now manufactured to meet new code C4 and to conform to the 1996 N.E.C. change.

### 4<sup>1</sup>/<sub>16</sub>" Square Device Covers

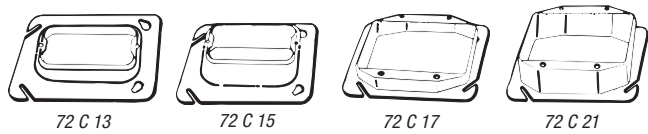

CAT. NO.	RAISED	CU. IN. CAP.	STD. CTN.
<b>For Single Device</b>			
72 C 62	1/4"	1.0	25
72 C 13	1/2"	3.0	25
72 C 14	3/4"	5.0	25
72 C 14 5/8	5/8"	4.0	25
72 C 15	1"	7.0	10
72 C 16	1 1/4"	8.3	10
<b>For Two Devices</b>			
72 C 17	1/2"	6.3	25
72 C 18	3/4"	9.0	25
72 C 18 5/8	5/8"	7.5	25
72 C 19	1"	12.0	25
72 C 21	1 1/4"	15.0	25

### 4<sup>1</sup>/<sub>16</sub>" Square Cut Tile Wall Covers

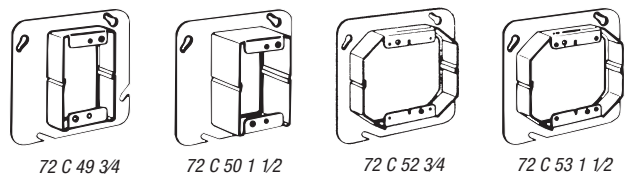

CAT. NO.	RAISED	CU. IN. CAP.	STD. CTN.
<b>For Single Device — Steel</b>			
72-C-49-1/2	1/2"	3.5	10
72 C 49 3/4	3/4"	5.3	10
72-C-49-1	1"	7.0	10
72-C-49-1-1/4	1 1/4"	7.0	10
72 C 50 1 1/2	1 1/2"	9.0	10
72 C 51 2	2"	14.5	20
<b>For Two Devices — Steel</b>			
72-C-52-1/2	1/2"	6.0	10
72 C 52 3/4	3/4"	9.0	10
72-C-52-1	1"	12.5	25
72-C-52-1-1/4	1 1/4"	15.5	25
72 C 53 1 1/2	1 1/2"	19.0	10
72 C 54 2	2"	25.5	10

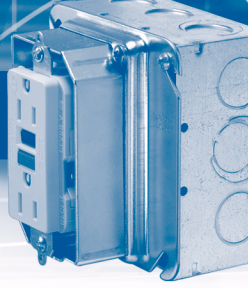

### 4" x 2 1/8" Utility Boxes



58351 1/2\*

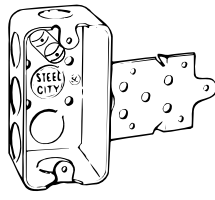

58351 B 1/4  
"B" bracket recessed 1/4"

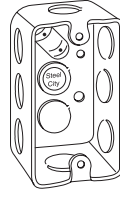

58361 1/2\*

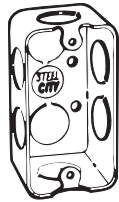

58361 3/4

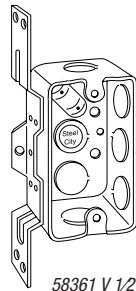

58361 V 1/2\*  
"CV" bracket recessed 1/2"

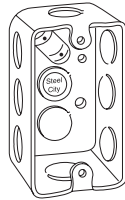

58371 1/2\*

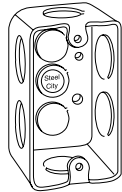

58371 3/4

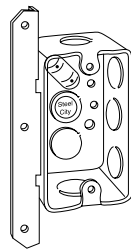

58371 T 1/2  
"T" bracket recessed 5/8"

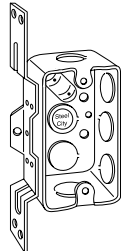

58371V1/2-25\*  
"CV" bracket recessed 1/2"

CAT. NO.	BRKTS.	KNOCKOUTS			STD. CTN.
		EA. SIDE CONDUIT	EA. END CONDUIT	BOTTOM CONDUIT	
<b>1 1/2" Deep — with Conduit KOs — 10.3 Cubic Inch Capacity</b>					
58351 1/2*	—	3-1/2"	1-1/2"	2-1/2"	50
58351 B 1/4	B	3-1/2"	1-1/2"	2-1/2"	25
<b>1 1/8" Deep — with Conduit KOs — 13.0 Cubic Inch Capacity</b>					
58361 1/2*	—	3-1/2"	1-1/2"	2-1/2"	50
58361 3/4	—	2-3/4"	1-3/4"	2-3/4"	50
58361 V 1/2*	CV	3-1/2"	1-1/2"	2-1/2"	50
<b>2 1/8" Deep — with Conduit KOs — 14.5 Cubic Inch Capacity</b>					
58371 1/2*	—	3-1/2"	1-1/2"	2-1/2"	50
58371 3/4	—	2-3/4"	1-3/4"	2-3/4"	50
58371 T 1/2*	T	3-1/2"	1-1/2"	2-1/2"	25
58371V1/2-25*	CV	3-1/2"	1-1/2"	2-1/2"	25

\* Factory provided raised ground screw location.

### 4 1/8" x 2 1/2" Utility Boxes

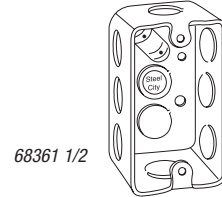

68361 1/2

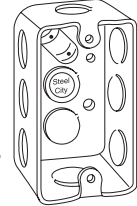

68371 1/2

CAT. NO.	KNOCKOUTS			STD. CTN.
	EA. SIDE CONDUIT	EA. END CONDUIT	BOTTOM CONDUIT	
<b>1 1/8" Deep — with Conduit KOs — 17.0 Cubic Inch Capacity</b>				
68361 1/2*	3-1/2"	1-1/2"	2-1/2"	25
<b>2 3/8" Deep — with Conduit KOs — 18.8 Cubic Inch Capacity</b>				
68371 1/2*	3-1/2"	1-1/2"	2-1/2"	50

\* Factory provided raised ground screw location.

### 4" x 2 1/8" Utility Box Covers

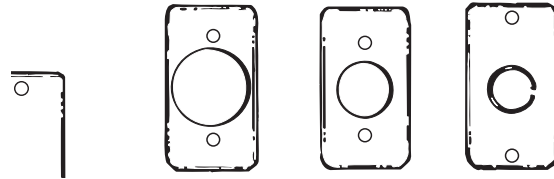

58 C 1

58 C 4

58 C 5

58 C 6

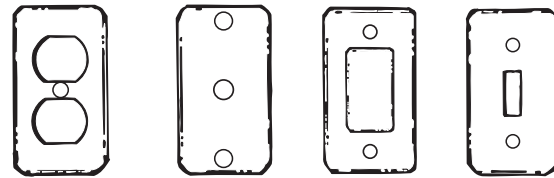

58 C 7

58 C 11

58 C 16

58 C 30

CAT. NO.	DIA. HOLE (IN.)	DESCRIPTION	STD. CTN.
<b>Raised 1/4"</b>			
58 C 1	—	Blank	100
58 C 4	1 10/32"	For 4-wire twist-lock single flush receptacle	25
58 C 5	1 13/32"	For single receptacle	25
58 C 6	—	With 1/2" KO	25
58 C 7	—	For duplex flush receptacle	100
58 C 11	—	With 15/32" bushed hole	25
58 C 16	—	For single GFCI receptacle	25
58 C 30	—	For one toggle switch	100

Includes captivated Phillips head screws.

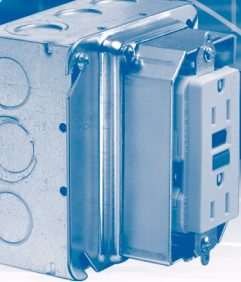

# Steel City®

## Utility / Gang Boxes and Accessories

Steel City® Metallic Boxes and Covers

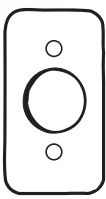

68 C 5



68 C 6

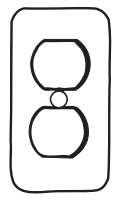

68 C 7

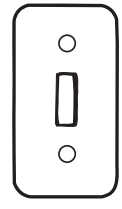

68 C 30

### 4 1/8" x 2 1/2" Utility Box Covers Raised 3/16"

68-C-1

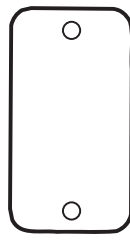

CAT. NO.	DIA. HOLE (IN.)	DESCRIPTION	STD. CTN.
68 C 1	—	Blank	25
68 C 5	1 1/2"	For single receptacle	25
68 C 6	—	With 1/2" KO	25
68 C 7	—	For duplex flush receptacle	25
68 C 30	—	For one toggle switch	25

Includes captivated Phillips head screws.

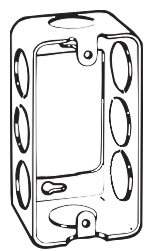

59361 1/2

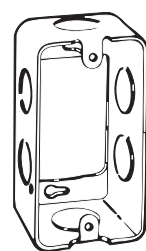

59361 3/4

### 4" x 2 1/8" Utility Box Extension Rings

CAT. NO.	KNOCKOUTS		STD. CTN.
	EA. SIDE CONDUIT	EA. END CONDUIT	
<b>1 1/8" Deep — with Conduit KOs — 13.0 Cubic Inch Capacity</b>			
59361 1/2	3-1/2"	1-1/2"	50
59361 3/4	2-3/4"	1-3/4"	25

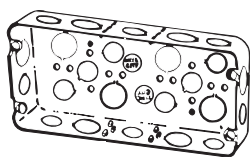

3G 1/2 3/4

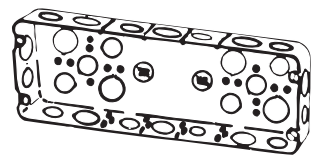

5G 1/2 3/4

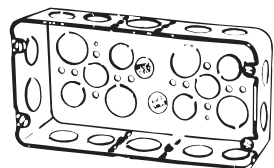

H3 BD 3/4 1

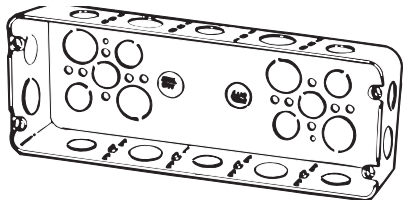

H5 BD 3/4 1

### Gang Boxes

CAT. NO.	LGTH.	KNOCKOUTS			CU. IN. CAP.	STD. CTN.
		EA. SIDE CONDUIT	EA. END CONDUIT	BOTTOM CONDUIT		
<b>4 1/2" High — 1 1/8" Deep — with Conduit KOs</b>						
2G 1/2 3/4	6 1/8"	2-1/2"	1-1/2"	3-1/2"	45.0	5
			2-3/4"	1-3/4"		
3G 1/2 3/4	8"	3-1/2"	1-1/2"	6-1/2"	58.0	5
			2-3/4"	1-3/4"		
4G 1/2 3/4	10 1/8"	3-1/2"	1-1/2"	6-1/2"	70.0	5
			3-3/4"	1-3/4"		
5G 1/2 3/4	12"	4-1/2"	1-1/2"	6-1/2"	85.0	1
			3-3/4"	1-3/4"		
6G 1/2 3/4	14 1/8"	4-1/2"	1-1/2"	6-1/2"	95.0	1
			4-3/4"	1-3/4"		

CAT. NO.	LGTH.	EA. SIDE CONDUIT	EA. END CONDUIT	BOTTOM CONDUIT	CU. IN. CAP.	STD. CTN.
H2BD 3/4 1	6 1/8"	2-3/4"	1-3/4"	3-1/2"	71.0	10
			1-1"	1-1"		
H3BD 3/4 1	8"	4-3/4"	1-3/4"	6-1/2"	90.0	10
			1-1"	1-1"		
H4BD 3/4 1	10 1/8"	2-3/4"	1-3/4"	6-1/2"	110.0	5
			2-1"	1-1"		
H5BD 3/4 1	12"	3-3/4"	1-3/4"	6-1/2"	132.0	5
			2-1"	1-1"		
H6BD 3/4 1	14 1/8"	3-3/4"	1-3/4"	6-1/2"	150.0	5
			3-1"	1-1"		



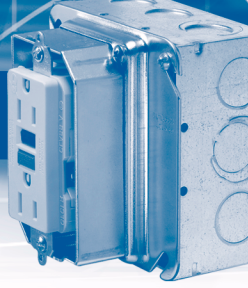

### Gang Box Partitions

CAT. NO.	DESCRIPTION	STD. CTN.
SGP	Hi-low voltage partition for 1 1/8" deep box	25
DGP	Hi-low voltage partition for 2 1/8" deep box	50

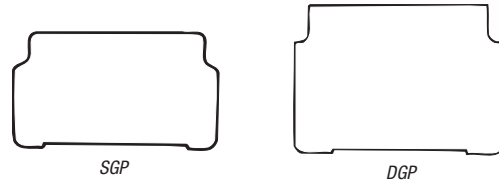

### 3 and 4 Gang Drawn-Style Device Boxes

CAT. NO.	BRACKETS	EA. SIDE CONDUIT	EA. END CONDUIT	STD. CTN.
<b>2 1/8" Deep — 3 Gang — 44.3 Cubic Inch, 4 Gang — 58.0 Cubic Inch</b>				
3G4D 1/2	—	3-1/2"	2-1/2"	20
3G4D B 1/2	B	3-1/2"	2-1/2"	20
3G4D V 1/2	CV	3-1/2"	2-1/2"	20
4G4D 1/2	—	4-1/2"	2-1/2"	20
4G4D B 1/2	B	4-1/2"	2-1/2"	20
4G4D V 1/2	CV	4-1/2"	2-1/2"	20

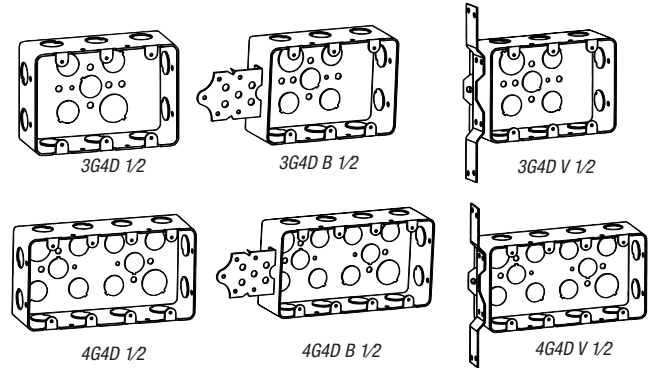

### Gang Box Covers

When covers are required to accommodate various combinations of devices, use the above catalog numbers plus the suffix "SPECIAL" and then indicate the combinations desired. When necessary, also indicate the sequence of devices.

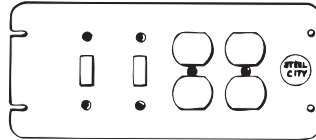

EXAMPLE: 4-GCS Special

- As illustrated (above), this is a 4-GCS Special for two toggle switches on left side and two duplex receptacles on right side.

CAT. NO.	LGTH. (IN.)	DESCRIPTION	CU. IN. CAP.	STD. CTN.
<b>4 1/8" Wide—Raised 13/16" for Plaster</b>				
2-GC	7	Holes between gangs are spaced on 1 1/8" centers; tapped holes in ears;	8.5	5
3-GC	8 1/8	spaced on 3 1/2" centers to accommodate	13.5	5
4-GC	10 1/8	all standard receptacles and switches;	18.3	5
5 GC	12 1/8	furnished with extra plugged screw holes;	23.0	5
6 GC	14 1/8	if these screw holes are used, the cover will fit the next smaller size box	28.3	5

#### 4 1/8" Wide — Flat, Blank

2-GCB	7	—	—	25
3-GCB	8 1/8	—	—	25
4-GCB	10 1/8	—	—	25
5 GCB	12 1/8	—	—	25
6 GCB	14 1/8	—	—	25

#### 4 1/8" Wide — Flat for Toggle Switches

2-GCS	7	For 2 toggle switches	—	25
3-GCS	8 1/8	For 3 toggle switches	—	25
4-GCS	10 1/8	For 4 toggle switches	—	25
5 GCS	12 1/8	For 5 toggle switches	—	25
6 GCS	14 1/8	For 6 toggle switches	—	25

4 1/8" wide — special covers — flat to accommodate combinations of devices.

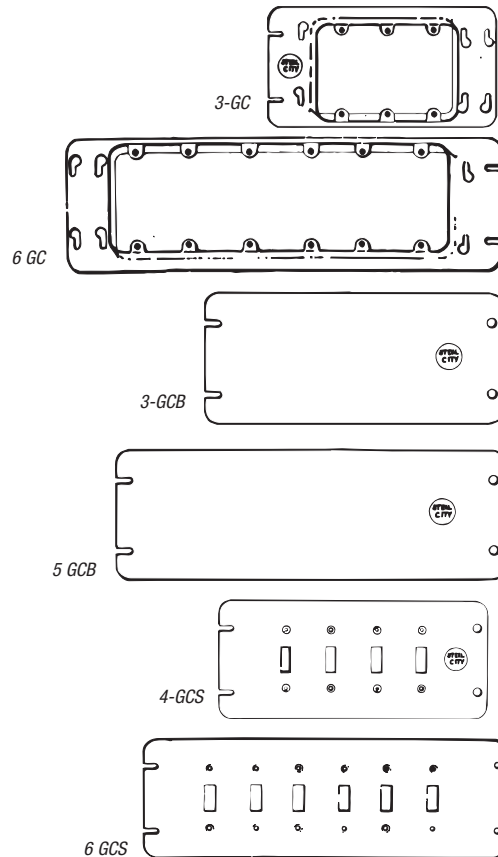

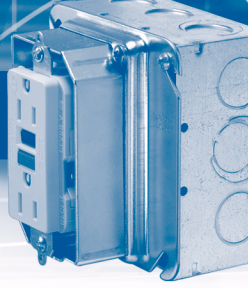

### Gang Box Partitions

CAT. NO.	DESCRIPTION	STD. CTN.
SGP	Hi-low voltage partition for 1 1/8" deep box	25
DGP	Hi-low voltage partition for 2 1/8" deep box	50

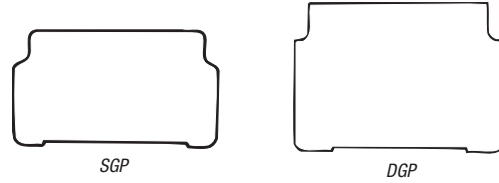

### 3 and 4 Gang Drawn-Style Device Boxes

CAT. NO.	BRACKETS	EA. SIDE CONDUIT	EA. END CONDUIT	STD. CTN.
<b>2 1/8" Deep — 3 Gang — 44.3 Cubic Inch, 4 Gang — 58.0 Cubic Inch</b>				
3G4D 1/2	—	3-1/2"	2-1/2"	20
3G4D B 1/2	B	3-1/2"	2-1/2"	20
3G4D V 1/2	CV	3-1/2"	2-1/2"	20
4G4D 1/2	—	4-1/2"	2-1/2"	20
4G4D B 1/2	B	4-1/2"	2-1/2"	20
4G4D V 1/2	CV	4-1/2"	2-1/2"	20

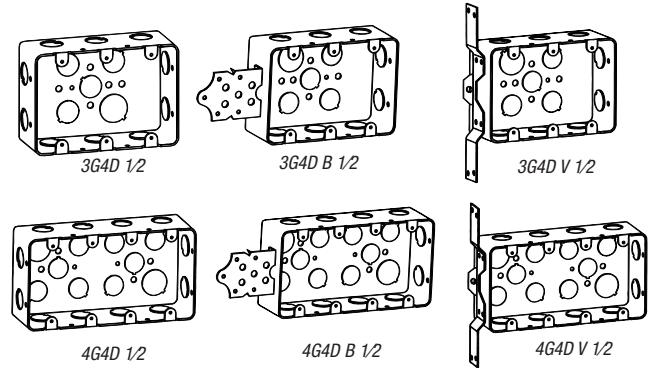

### Gang Box Covers

When covers are required to accommodate various combinations of devices, use the above catalog numbers plus the suffix "SPECIAL" and then indicate the combinations desired. When necessary, also indicate the sequence of devices.

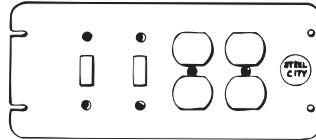

EXAMPLE: 4-GCS Special

- As illustrated (above), this is a 4-GCS Special for two toggle switches on left side and two duplex receptacles on right side.

CAT. NO.	LGTH. (IN.)	DESCRIPTION	CU. IN. CAP.	STD. CTN.
<b>4 1/8" Wide—Raised 13/16" for Plaster</b>				
2-GC	7	Holes between gangs are spaced on 1 1/8" centers; tapped holes in ears;	8.5	5
3-GC	8 1/8	spaced on 3 1/2" centers to accommodate	13.5	5
4-GC	10 1/8	all standard receptacles and switches;	18.3	5
5 GC	12 1/8	furnished with extra plugged screw holes;	23.0	5
6 GC	14 1/8	if these screw holes are used, the cover will fit the next smaller size box	28.3	5

#### 4 1/8" Wide — Flat, Blank

2-GCB	7	—	—	25
3-GCB	8 1/8	—	—	25
4-GCB	10 1/8	—	—	25
5 GCB	12 1/8	—	—	25
6 GCB	14 1/8	—	—	25

#### 4 1/8" Wide — Flat for Toggle Switches

2-GCS	7	For 2 toggle switches	—	25
3-GCS	8 1/8	For 3 toggle switches	—	25
4-GCS	10 1/8	For 4 toggle switches	—	25
5 GCS	12 1/8	For 5 toggle switches	—	25
6 GCS	14 1/8	For 6 toggle switches	—	25

4 1/8" wide — special covers — flat to accommodate combinations of devices.

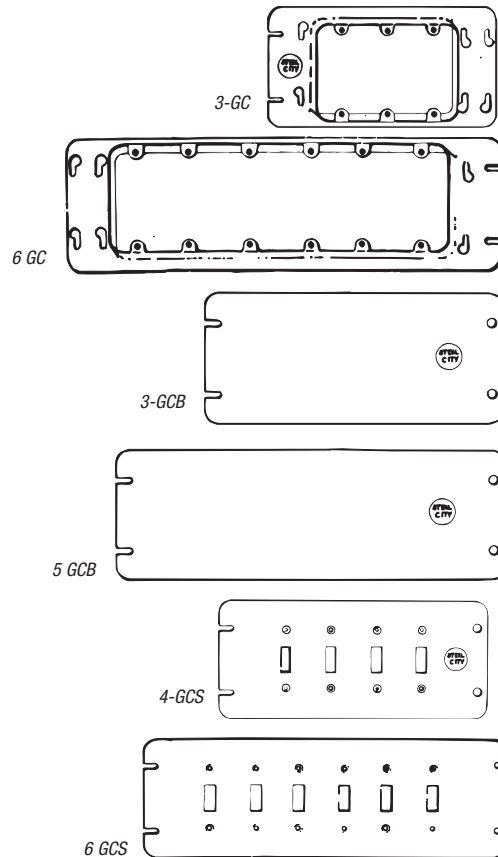

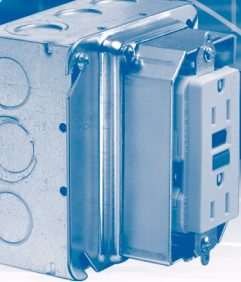

# Steel City®

## Concrete Boxes and Accessories

Steel City® Metallic Boxes and Covers

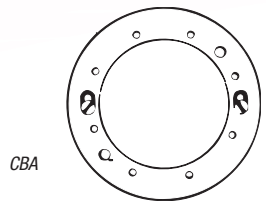

CBA

### Concrete Box Adapter

CAT. NO.	DESCRIPTION	STD. CTN.
CBA	For quick mounting and alignment of 4" octagon extension ring on concrete box or hung ceiling box	25

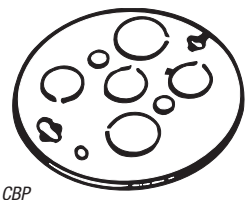

CBP

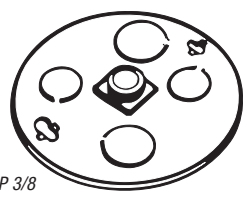

CBP 3/8

### Concrete Box Cover Plate

- Thread size: 3/8"-18 NPS

CAT. NO.	DESCRIPTION	STD. CTN.
CBP	No Stud. 3 1/2" and 2 3/4" KOs	25
CBP 3/8	With 3/8" fixture stud; 2 1/2" and 3/4" KOs	25

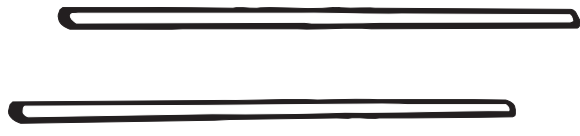

Two bars required for each box.

### Bars for Hanging Ceiling Boxes

CAT. NO.	LGTH.	STD. CTN.
HBB 18	18"	40
HBB-24	24"	40
HBB-30	30"	40

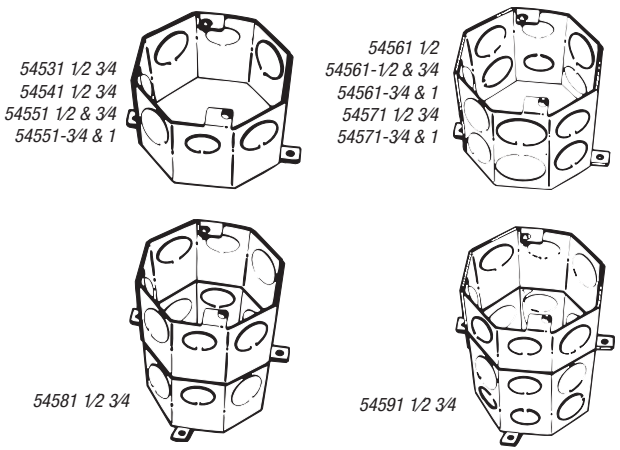

54531 1/2 3/4  
54541 1/2 3/4  
54551 1/2 & 3/4  
54551-3/4 & 1

54561 1/2  
54561-1/2 & 3/4  
54561-3/4 & 1  
54571 1/2 3/4  
54571-3/4 & 1

54581 1/2 3/4

54591 1/2 3/4

### 4" Octagon Concrete Boxes

CAT. NO.	CU. IN. CAP.	DEPTH (IN.)	KNOCKOUTS	STD. CTN.
<b>With Conduit KOs</b>				
54531 1/2 3/4	23.0	2	1/2" & 3/4" single row	25
54541 1/2 3/4	29.0	2 1/2	1/2" & 3/4" single row	25
54551 1/2 & 3/4	35.0	3	1/2" & 3/4" single row	20
54551-3/4 & 1	35.0	3	3/4" & 1" single row	20
54561 1/2	41.0	3 1/2	1/2" double row	20
54561-1/2 & 3/4	41.0	3 1/2	1/2" & 3/4" double row	20
54561-3/4 & 1	41.0	3 1/2	3/4" & 1" double row	20
54571 1/2 3/4	47.0	4	1/2" & 3/4" double row	10
54571-3/4 & 1	47.0	4	3/4" & 1" double row	10
54581 1/2 3/4	58.0	5	1/2" & 3/4" double row	10
54591 1/2 3/4	70.0	6	1/2" & 3/4" three rows	10

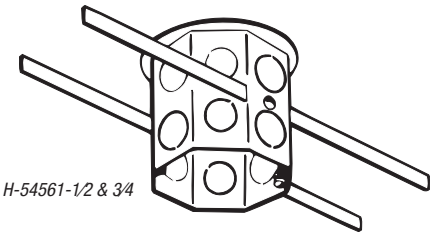

H-54561-1/2 & 3/4

### 4" Octagon Hanging Ceiling Boxes

CAT. NO.	KNOCKOUTS	STD. CTN.
<b>3 1/2" Deep — with Conduit KOs — 41.0 Cubic Inch Capacity</b>		
H-54561-1/2 & 3/4	1/2" & 3/4" double row	20
H-54561-3/4	3/4" double row	20



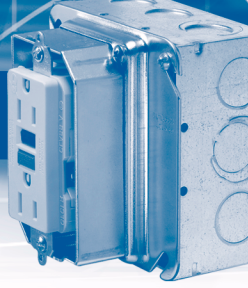

### Gangable Masonry Boxes



CAT. NO.	LENGTH	CU. IN. CAP.	ECCENTRIC KNOCKOUTS ½" & ¾"			STD. CTN.
			EA. SIDE	EA. END	BOTTOM	
<b>2 ½" Deep — 3 ¾" High — with Eccentric Conduit KOs</b>						
GW 125 G*	1 ½"	15.0	2	2	2	20
GW 225 G*	3 ¾"	31.6	2	4	4	10
GW 325 G*	5 ½"	47.4	2	6	6	5
GW 425 G	7"	64.0	2	8	8	5
GW 525 G	9 ½"	79.0	2	10	10	5
GW-625-G*	11"	94.8	2	12	12	1

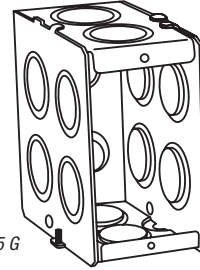

GW 135 G

CAT. NO.	LENGTH	CU. IN. CAP.	ECCENTRIC KNOCKOUTS ½" & ¾"			STD. CTN.
			EA. SIDE	EA. END	BOTTOM	
<b>3 ½" Deep — 3 ¾" High — with Eccentric Conduit KOs</b>						
GW 135 G*	1 ½"	22.0	4	2	2	20
GW 235 G*	3 ¾"	46.9	4	4	4	10
GW 335 G	5 ½"	71.0	4	6	6	10
GW 435 G*†	7"	93.5	4	8	8	5
GW-535-G†	9 ½"	111.7	4	10	10	5
GW-635-G*†	11"	134.0	4	12	12	1

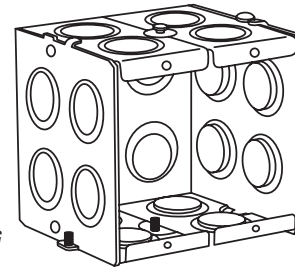

GW 235 G

\* Per N.E.C. suitable for use without a bonding jumper in circuits above or below 250 volts.

† 4, 5 and 6 gang supplied with partitions.

### 1" KO Masonry Box

CAT. NO.	LENGTH	CU. IN. CAP.	ECCENTRIC KNOCKOUTS ½" & ¾"			STD. CTN.
			EA. SIDE	EA. END	BOTTOM	
<b>Non-Gangable Single Gang</b>						
GW 135 NG-1	1"	22	2	1	2	10

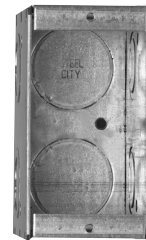

GW 135 NG-1

**NEW!**

### Thru-Wall Boxes for Concrete Block

CAT. NO.	DEPTH (IN.)	CU. IN. CAP.	KNOCKOUTS		STD. CTN.
			EA. SIDE CONDUIT	EA. END CONDUIT	
<b>2 ½" Wide x 3 ½" Long — with Conduit KOs</b>					
CBTW 4	3 ½"	24.0	2 ½"-¾" concentric	1 ½"-¾" concentric	10
CBTW 6	5 ½"	38.0	4 ½"-¾" concentric	2 ½"-¾" concentric	10
CBTW 8	7"	52.3	6 ½"-¾" concentric	3 ½"-¾" concentric	10

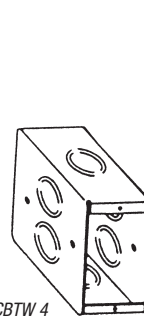

CBTW 4



CBTW 6

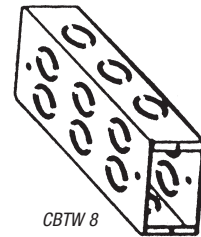

CBTW 8

### Masonry Box Partitions



CAT. NO.	DESCRIPTION	STD. CTN.
PGW-25-G	Non-metallic partition for 2 ½" deep steel tile wall boxes	25
PGW-35-G	Non-metallic partition for 3 ½" deep steel tile wall boxes	25

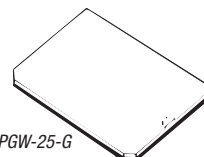

PGW-25-G

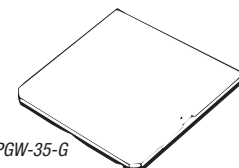

PGW-35-G

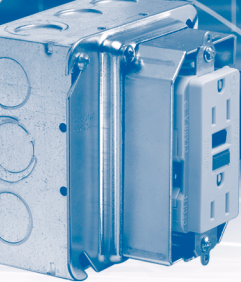

# Steel City®

## Pre-Assemblies

Steel City® Metallic Boxes and Covers

### Faster Installation for Increased Profit Margin!

#### Pre-Assemblies

Paying to assemble outlet boxes, grounding pigtails, device covers and mounting brackets on the job site can quickly become an expensive proposition. Instead, choose Steel City Pre-Assemblies and realize significant labor savings. This UL® Listed product line includes over 75 combinations of popular boxes, brackets and covers that speed installation because the time-consuming assembly work is already done for you.

Steel City Pre-Assemblies include:

- Outlet box with pre-installed grounding pigtail
- Your choice of cover options, including single- and double-device covers, raised 1/2", 5/8" or 3/4"
- Your choice of bracket options to allow mounting to steel and wood stud or floor track, including Steel City Box Support Covers, which combine a bracket and cover in one component
- All UL® Listed components

**NEW!**



### Box with Pre-Installed 10 1/2" Pigtail

- Popular 4" square boxes and switch boxes
- Pre-installed 10 1/2" insulated grounding pigtails
- Save on labor costs by eliminating multiple installation steps

### Pre-Assembled Installation VS. Standard Installation

<ol style="list-style-type: none"> <li>1 Install box in desired location — <b>DONE!</b></li> </ol>	<ol style="list-style-type: none"> <li>1 Purchase pre-stripped pigtail</li> <li>2 Install pigtail and ground screw in box</li> <li>3 Install box in desired location</li> </ol>
--	---

CAT. NUMBER	BOX TYPE INCLUDED	KNOCKOUTS	PRE-INSTALLED PIGTAIL	STD. PKG. QTY.
521511234EWP	52151234EW 4"-sq. x 1 1/2"D Welded Box	Eccentric	10 1/2"	50
521511234P	521511234 4"-sq. x 1 1/2"D Drawn Box	1/2" & 3/4"	10 1/2"	50
521711234EP	521711234E 4"-sq. x 2 1/8"D Welded Box	1/2" & 3/4" Eccentric	10 1/2"	50
52151XP	52151X 4"-sq. x 1 1/2"D Welded Box	1/2" & 3/4" Eccentric	10 1/2"	50
52151CVNP	52151CVN 4"-sq. x 1 1/2"D Welded Box	1/2" & 3/4" Eccentric	10 1/2"	25
LXWOWP	LXWOW-25 3"H x 2"W x 2 1/2"D Gangable Switch Box	1/2"	10 1/2"	25
LXVP	LXV-25 3"H x 2"W x 2 1/2"D Gangable Switch Box	1/2"	10 1/2"	25
CXWOWP	CXWOW 3"H x 2"W x 3 1/2"D Gangable Switch Box	1/2" & 3/4"	10 1/2"	25
CXWVP	CXWV 3"H x 2"W x 3 1/2"D Gangable Switch Box	1/2" & 3/4"	10 1/2"	25
CXP	CX 3"H x 2"W x 3 1/2"D Gangable Switch Box	1/2" & 3/4"	10 1/2"	25

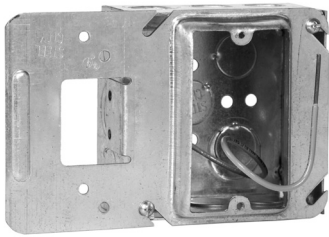
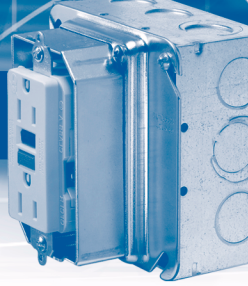

52171-CM14-5/8

### Box with Pre-Installed 10½" Pigtail and Box Support Cover

- 52CM and 52CMD Box Support Covers
- 10½" insulated Pigtail
- One and two device covers
- Raised ½", ⅝" and ¾"
- 1½" and 2⅝" box depths

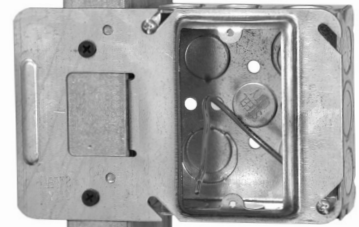

CAT. NO.	BOX TYPE INCLUDED	BOX DEPTH	PIGTAIL TYPE INCLUDED	BOX SUPPORT COVER INCLUDED	RAISED		NO. OF DEVICES	STD. CTN.
52151-CM13	521511234EW	1½"	GSC12	52CM13	½"		1	25
52151-CM14-5/8	521511234EW	1½"	GSC12	52CM14-5/8	⅝"		1	25
52151-CM14	521511234EW	1½"	GSC12	52CM14	¾"		1	25
52151-CMD17	521511234EW	1½"	GSC12	52CMD17	½"		2	25
52151-CMD18-5/8	521511234EW	1½"	GSC12	52CMD18-5/8	⅝"		2	25
52151-CMD18	521511234EW	1½"	GSC12	52CMD18	¾"		2	25
52171-CM13	521711234E	2⅝"	GSC12	52CM13	½"		1	25
52171-CM14-5/8	521711234E	2⅝"	GSC12	52CM14-5/8	⅝"		1	25
52171-CM14	521711234E	2⅝"	GSC12	52CM14	¾"		1	25
52171-CMD17	521711234E	2⅝"	GSC12	52CMD17	½"		2	25
52171-CMD18-5/8	521711234E	2⅝"	GSC12	52CMD18-5/8	⅝"		2	25
52171-CMD18	521711234E	2⅝"	GSC12	52CMD18	¾"		2	25

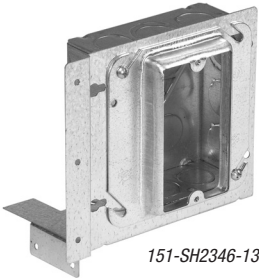

151-SH2346-13

### Box with Pre-Installed 10½" Pigtail, Raised Cover and Box-to-Stud Bracket

- SSF-SH2346 Bracket
- 10½" insulated Pigtail
- One and two device covers
- Raised ½", ⅝" and ¾"
- 1½" and 2⅝" box depths

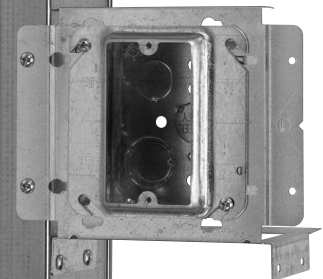

CAT. NO.	BOX TYPE INCLUDED	BOX DEPTH	PIGTAIL TYPE INCLUDED	BRACKET TYPE INCLUDED	COVER TYPE INCLUDED	RAISED		NO. OF DEVICES	STD. CTN.
151-SH2346-13	521511234EW	1½"	GSC12	SSF-SH2346	52-C-13	½"		1	10
151-SH2346-1458	521511234EW	1½"	GSC12	SSF-SH2346	52-C-14-5/8	⅝"		1	10
151-SH2346-14	521511234EW	1½"	GSC12	SSF-SH2346	52-C-14	¾"		1	10
151-SH2346-17	521511234EW	1½"	GSC12	SSF-SH2346	52-C-17-25	½"		2	10
151-SH2346-1858	521511234EW	1½"	GSC12	SSF-SH2346	52-C-18-5/8-25	⅝"		2	10
151-SH2346-18	521511234EW	1½"	GSC12	SSF-SH2346	52-C-18	¾"		2	10
171-SH2346-13	521711234E	2⅝"	GSC12	SSF-SH2346	52-C-13	½"		1	10
171-SH2346-1458	521711234E	2⅝"	GSC12	SSF-SH2346	52-C-14-5/8	⅝"		1	10
171-SH2346-14	521711234E	2⅝"	GSC12	SSF-SH2346	52-C-14	¾"		1	10
171-SH2346-17	521711234E	2⅝"	GSC12	SSF-SH2346	52-C-17-25	½"		2	10
171-SH2346-1858	521711234E	2⅝"	GSC12	SSF-SH2346	52-C-18-5/8-25	⅝"		2	10
171-SH2346-18	521711234E	2⅝"	GSC12	SSF-SH2346	52-C-18	¾"		2	10



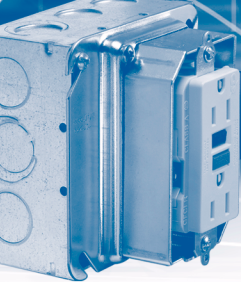

# Steel City®

## Pre-Assemblies

**NEW!**

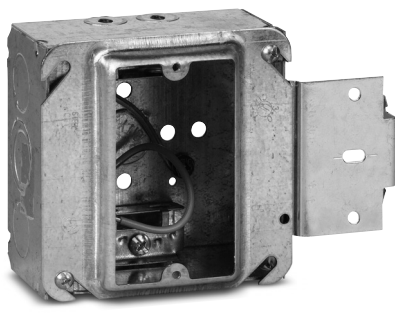

### “MS” Series Pre-Assemblies

- 4" square and 4<sup>11</sup>/<sub>16</sub>" square boxes
- 1<sup>1</sup>/<sub>2</sub>" deep or 2<sup>1</sup>/<sub>8</sub>" deep
- Pre-installed 10<sup>1</sup>/<sub>2</sub>" insulated grounding pigtail
- Available with conduit KOs or clamps for flexible/armored/MC cable
- Save on labor costs by eliminating multiple installation steps

**Pre-Assembled Installation VS. Standard Installation**

<ol style="list-style-type: none"> <li>1 Snap box — <b>DONE!</b></li> </ol>	<ol style="list-style-type: none"> <li>1 Purchase pre-stripped pigtail</li> <li>2 Install pigtail and ground screw in box</li> <li>3 Mount box support cover to box</li> <li>4 Mount assembly to stud</li> </ol>
---	--

Steel City® Metallic Boxes and Covers



CAT NO.	BOX TYPE INCLUDED	BOX DEPTH	PIGTAIL INCLUDED	BOX COVER INCLUDED	RAISED	NO. OF DEVICES	STD. CTN.
151-MS-13	52151-MS-1/2 3/4	1 <sup>1</sup> / <sub>2</sub> "	10 <sup>1</sup> / <sub>2</sub> "	52-C-13	1/2"	1	25
151-MS-14	52151-MS-1/2 3/4	1 <sup>1</sup> / <sub>2</sub> "	10 <sup>1</sup> / <sub>2</sub> "	52-C-14	3/4"	1	25
151-MS-1458	52151-MS-1/2 3/4	1 <sup>1</sup> / <sub>2</sub> "	10 <sup>1</sup> / <sub>2</sub> "	52-C-14-5/8	5/8"	1	25
171MS13	52171-MS-1/2 3/4	2 <sup>1</sup> / <sub>8</sub> "	10 <sup>1</sup> / <sub>2</sub> "	52-C-13	1/2"	1	25
171-MS-14	52171-MS-1/2 3/4	2 <sup>1</sup> / <sub>8</sub> "	10 <sup>1</sup> / <sub>2</sub> "	52-C-14	3/4"	1	25
171-MS-1458	52171-MS-1/2 3/4	2 <sup>1</sup> / <sub>8</sub> "	10 <sup>1</sup> / <sub>2</sub> "	52-C-14-5/8	5/8"	1	25
171MS18	52171-MS-1/2 3/4	2 <sup>1</sup> / <sub>8</sub> "	10 <sup>1</sup> / <sub>2</sub> "	52-C-18	3/4"	2	25
171-MS-18 5/8	52171-MS-1/2 3/4	2 <sup>1</sup> / <sub>8</sub> "	10 <sup>1</sup> / <sub>2</sub> "	52-C-18-5/8-25	5/8"	2	25
171MSX13	52171-MSX	2 <sup>1</sup> / <sub>8</sub> "	10 <sup>1</sup> / <sub>2</sub> "	52-C-13	1/2"	1	25
171-MSX-14	52171-MSX	2 <sup>1</sup> / <sub>8</sub> "	10 <sup>1</sup> / <sub>2</sub> "	52-C-14	3/4"	1	25
171-MSX-1458	52171-MSX	2 <sup>1</sup> / <sub>8</sub> "	10 <sup>1</sup> / <sub>2</sub> "	52-C-14-5/8	5/8"	1	25
171MSX18	52171-MSX	2 <sup>1</sup> / <sub>8</sub> "	10 <sup>1</sup> / <sub>2</sub> "	52-C-18	3/4"	2	25
171-MSX-18 5/8	52171-MSX	2 <sup>1</sup> / <sub>8</sub> "	10 <sup>1</sup> / <sub>2</sub> "	52-C-18-5/8-25	5/8"	2	25
72171MS14	72171-MS-1/2 3/4	2 <sup>1</sup> / <sub>8</sub> "	10 <sup>1</sup> / <sub>2</sub> "	72-C-14	3/4"	1	25
72171-MS-1458	72171-MS-1/2 3/4	2 <sup>1</sup> / <sub>8</sub> "	10 <sup>1</sup> / <sub>2</sub> "	72-C-14-5/8	5/8"	1	25
72171MS18	72171-MS-1/2 3/4	2 <sup>1</sup> / <sub>8</sub> "	10 <sup>1</sup> / <sub>2</sub> "	72-C-18	3/4"	2	25
72171-MS-18 5/8	72171-MS-1/2 3/4	2 <sup>1</sup> / <sub>8</sub> "	10 <sup>1</sup> / <sub>2</sub> "	72-C-18-5/8	5/8"	2	25
72171MSX14	72171-MS-1/2 3/4	2 <sup>1</sup> / <sub>8</sub> "	10 <sup>1</sup> / <sub>2</sub> "	72-C-14	3/4"	1	25
72171-MSX-1458	72171-MSX	2 <sup>1</sup> / <sub>8</sub> "	10 <sup>1</sup> / <sub>2</sub> "	72-C-14-5/8	5/8"	1	25
72171MSX18	72171-MS-1/2 3/4	2 <sup>1</sup> / <sub>8</sub> "	10 <sup>1</sup> / <sub>2</sub> "	72-C-18	3/4"	2	25
72171-MSX-1858	72171-MS-1/2 3/4	2 <sup>1</sup> / <sub>8</sub> "	10 <sup>1</sup> / <sub>2</sub> "	72-C-18-5/8	5/8"	2	25

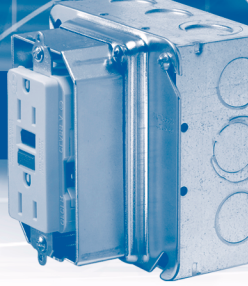

### Box with Pre-Installed 10½" Pigtail, Raised Cover and Vertical Mounting Bracket

- 12" (SSF-SV12) or 18" (SSF-SV18) vertical mounting bracket
- 10½" insulated Pigtail
- One and two device covers
- Raised ½", ⅝" and ¾"
- 1½" and 2⅝" box depths

**NEW!**

#### Pre-Assembled Installation *VS.* Standard Installation

**1** Mount assembly to floor stud — **DONE!**

- 1** Purchase pre-stripped pigtail
- 2** Install pigtail and ground screw in box
- 3** Insert box into vertical bracket
- 4** Insert device cover to vertical bracket
- 5** Mount assembly to floor stud

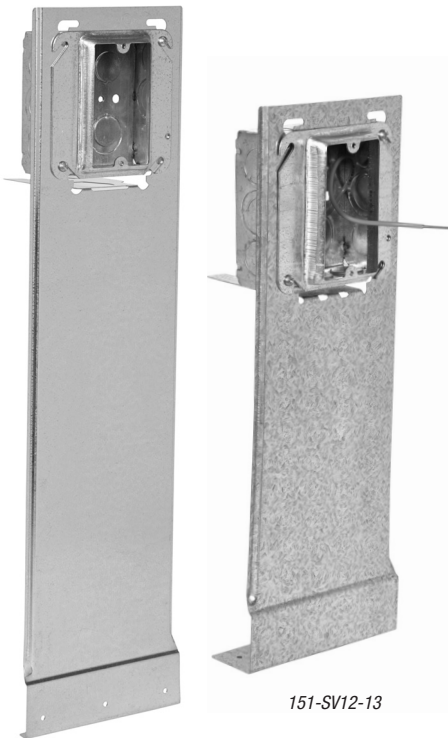

151-SV18-13

151-SV12-13



CAT. NO.	BOX TYPE INCLUDED	BOX DEPTH	PIGTAIL TYPE INCLUDED	BRACKET TYPE INCLUDED	COVER TYPE INCLUDED	RAISED	NO. OF DEVICES	STD. CTN.
151-SV12-13	521511234EW	1½"	GSC12	SSF-SV12	52-C-13	½"	1	10
151-SV12-1458	521511234EW	1½"	GSC12	SSF-SV12	52-C-14-5/8	⅝"	1	10
151-SV12-14	521511234EW	1½"	GSC12	SSF-SV12	52-C-14	¾"	1	10
151-SV12-17	521511234EW	1½"	GSC12	SSF-SV12	52-C-17-25	½"	2	10
151-SV12-1858	521511234EW	1½"	GSC12	SSF-SV12	52-C-18-5/8-25	⅝"	2	10
151-SV12-18	521511234EW	1½"	GSC12	SSF-SV12	52-C-18	¾"	2	10
171-SV12-13	521711234E	2⅝"	GSC12	SSF-SV12	52-C-13	½"	1	10
171-SV12-1458	521711234E	2⅝"	GSC12	SSF-SV12	52-C-14-5/8	⅝"	1	10
171-SV12-14	521711234E	2⅝"	GSC12	SSF-SV12	52-C-14	¾"	1	10
171-SV12-17	521711234E	2⅝"	GSC12	SSF-SV12	52-C-17-25	½"	2	10
171-SV12-1858	521711234E	2⅝"	GSC12	SSF-SV12	52-C-18-5/8-25	⅝"	2	10
171-SV12-18	521711234E	2⅝"	GSC12	SSF-SV12	52-C-18	¾"	2	10
151-SV18-13	521511234EW	1½"	GSC12	SSF-SV18	52-C-13	½"	1	10
151-SV18-1458	521511234EW	1½"	GSC12	SSF-SV18	52-C-14-5/8	⅝"	1	10
151-SV18-14	521511234EW	1½"	GSC12	SSF-SV18	52-C-14	¾"	1	10
151-SV18-17	521511234EW	1½"	GSC12	SSF-SV18	52-C-17-25	½"	2	10
151-SV18-1858	521511234EW	1½"	GSC12	SSF-SV18	52-C-18-5/8-25	⅝"	2	10
151-SV18-18	521511234EW	1½"	GSC12	SSF-SV18	52-C-18	¾"	2	10
171-SV18-13	521711234E	2⅝"	GSC12	SSF-SV18	52-C-13	½"	1	10
171-SV18-1458	521711234E	2⅝"	GSC12	SSF-SV18	52-C-14-5/8	⅝"	1	10
171-SV18-14	521711234E	2⅝"	GSC12	SSF-SV18	52-C-14	¾"	1	10
171-SV18-17	521711234E	2⅝"	GSC12	SSF-SV18	52-C-17-25	½"	2	10
171-SV18-1858	521711234E	2⅝"	GSC12	SSF-SV18	52-C-18-5/8-25	⅝"	2	10
171-SV18-18	521711234E	2⅝"	GSC12	SSF-SV18	52-C-18	¾"	2	10

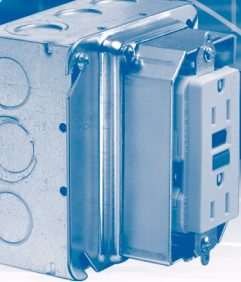

# Steel City®

## Pre-Fab Components

Steel City® Metallic Boxes and Covers

### Easily Pre-Assembled Off-Site for Faster Installation On-Site!

#### Pre-Fabricated Components

Rather than assembling box mounting brackets and device covers on-site, keep an eye on profit and use Steel City Pre-Fab Components to set up jobs off-site for a quick and easy installation on-site. They accommodate a wide variety of Steel City covers and they're readily available for fast-track projects.

- Ideal for use in hotels, casinos, hospitals, large office buildings, and any other commercial or institutional application where rough-in products can be pre-fabricated to match floor plans for quicker on-site installation
- Items readily available for fast-track projects — no special lead time required
- All products are UL® approved and meet applicable building codes

### SB016 and SB024 Stud-to-Stud Horizontal Mounting Brackets

- Constructed of 24-gauge steel
- Pre-measured on center for 16" (SB016) or 24" (SB024) stud spacing
- SB016 accepts three 4" square or two 4<sup>11</sup>/<sub>16</sub>" boxes (deep or shallow)
- SB024 accepts five 4" square or four 4<sup>11</sup>/<sub>16</sub>" boxes (deep or shallow)
- Can be mounted at any height to meet individual project requirements
- Versatile, open design enables mounting of box in any location across horizontal plane between studs
- Device cover (mud ring) mounts to front of bracket to set box in desired location
- Stamped rule on bracket with ¼", ½", and 1" markings enables fast box setting



#### Stud-to-Stud Horizontal Mounting Brackets



CAT. NO.	DESCRIPTION	STD. CTN.
SB016	16" stud-to-stud horizontal mounting bracket	25
SB024	24" stud-to-stud horizontal mounting bracket	25

### SV1218 Floor-Track 12" and 18" Vertical Mounting Bracket

- Code-standard SV1218 bracket mounts to floor track easily with screws through three pre-punched holes in bottom plate (only two screws required for most applications)
- Offers pre-measured box-mount locations at 12" and 18" from floor — fast installation with no measuring required
- Accepts 4" square or 4<sup>11</sup>/<sub>16</sub>" boxes (deep or shallow) with standard device covers (mud rings)
- Supplied with horizontal cross-support bar for stability after installation — prevents unit from falling into open space between walls when sheetrock is applied
- Support bar sits in two slotted tabs on backside of vertical bracket and mounts from stud to stud horizontally
- Support bar pre-measured for 24" stud cavities (score lines provided for 16" stud cavities) with pre-punched holes at stud locations for left or right stud installation
- Add optional SVX adapter plate to expand box capacity
- Optional SVX adapter plate installs to pre-punched and tapped holes on sides of SV1218
- Up to two SVX plates can be added with 24" stud spacing
- One SVX plate can be added with 16" stud spacing
- SVX adapter plate accepts all device covers for 4" and 4<sup>11</sup>/<sub>16</sub>" boxes





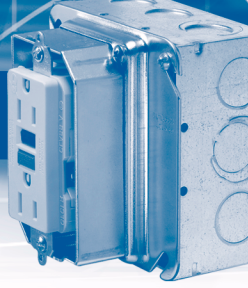

SB016



SB024

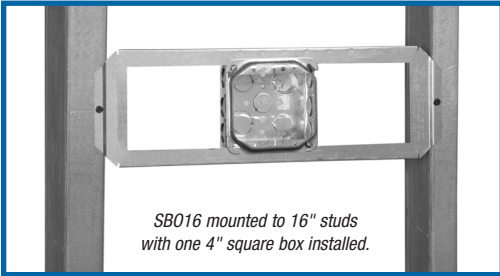

SB016 mounted to 16" studs with one 4" square box installed.

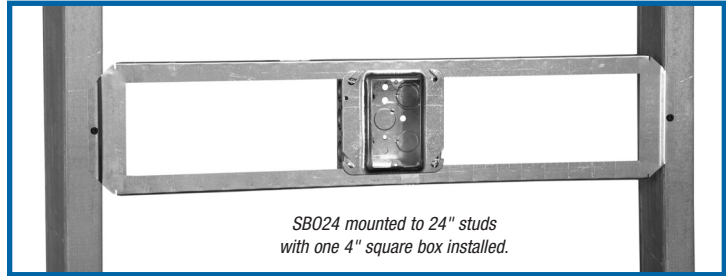

SB024 mounted to 24" studs with one 4" square box installed.

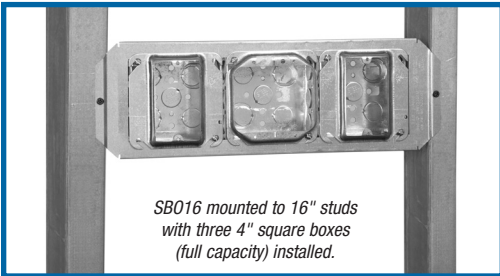

SB016 mounted to 16" studs with three 4" square boxes (full capacity) installed.

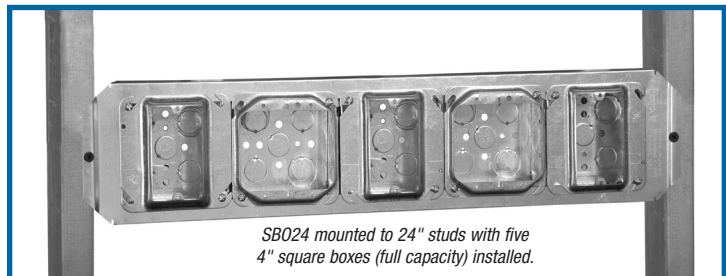

SB024 mounted to 24" studs with five 4" square boxes (full capacity) installed.

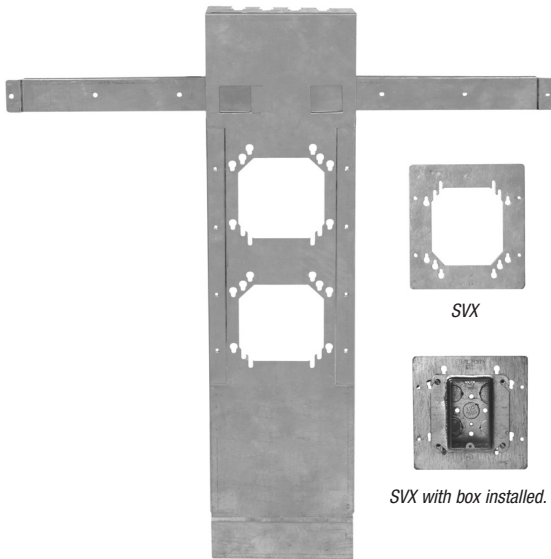

SV1218

SVX

SVX with box installed.

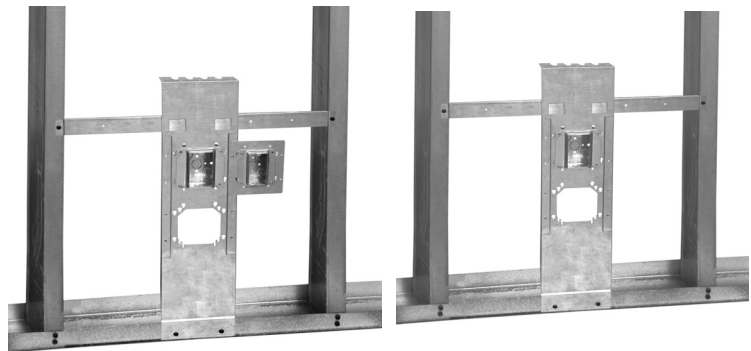

SV1218 mounted to floor track and studs with one 4" square box installed and optional SVX adapter plate with one box installed.

SV1218 mounted to floor track and studs with one 4" square box installed.

### Floor-Track 12" and 18" Vertical Mounting Bracket



CAT. NO.	DESCRIPTION	STD. CTN.
SV1218	Floor-track vertical mounting bracket with supporting horizontal cross bar	10
SVX	Adapter plate for expanded capacity for SV1218	25

### Adjustable Bar Hangers for Plaster and Drywall

Packaged complete with either...

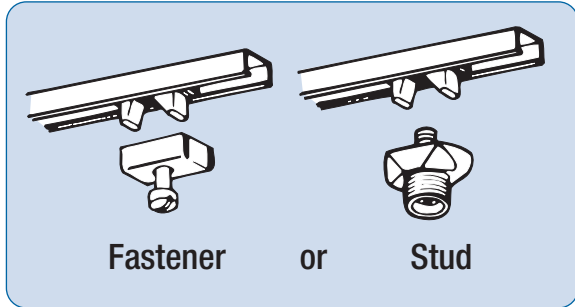

#### Ease of Installation:

Claws provide temporary support for proper positioning until permanently installed.

#### Two adjustable lengths

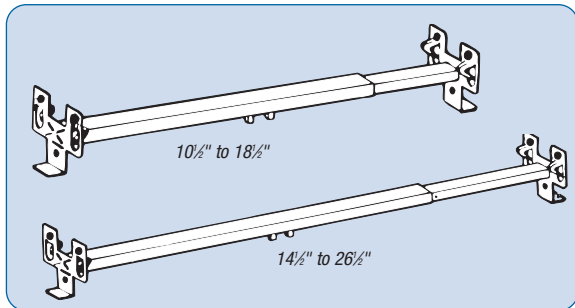

#### ½", ¾", 7⁄8" Lath and Plaster

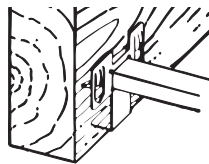
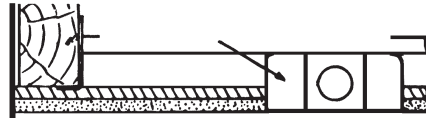

Accurate and automatic positioning on joist.

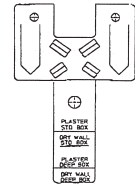

Endplate locator tab is scored and marked for lath and plaster applications with standard and deep boxes.

#### ¾", 1½", 5⁄8" Drywall Board

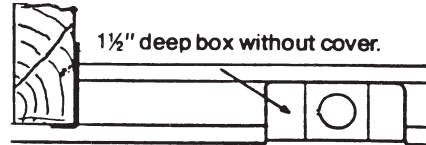

Foot straightened gauges for 1½" deep box with cover or 2½" deep box without cover. With foot broken off gauges for shallow pan box.



CAT. NO.	DEPTH OF END PLATE (IN.)	BAR LGTH. (IN.)	STUD OR FASTENER	STD. CTN.
<b>For ¾", 1½" and 5⁄8" Wall Board and Plaster — 50 lb. Max. Load Rating</b>				
6010DW-25	1¾	10½–18½	Stud	25
6010ADW-25	1¾	14½–26½	Stud	25
6011DW-25	1¾	10½–18½	Fastener	25
6011ADW-25	1¾	14½–26½	Fastener	25

\*Score marks for drywall and plaster depths

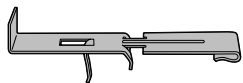

Fig. 1

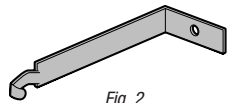

Fig. 2

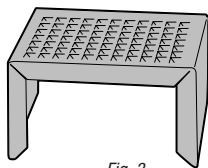
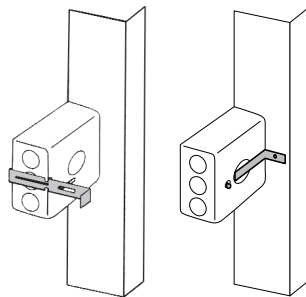
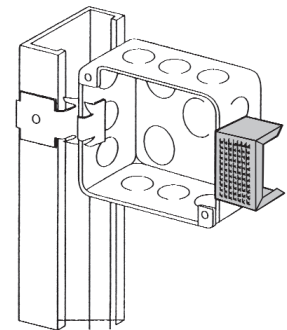

Fig. 3



### Far Side Box Support

- Provides side support for electrical boxes
- Works with most electrical boxes for 2½", 3½" and 4" metal stud depths



CAT. NO.	FIG. NO.	DESCRIPTION	STD. CTN.
SS1-TB	1	Far side box support	100
50-SC	2	Box brace for 4" square or octagonal box	100
SSF-SX	3	Electrical box support	100

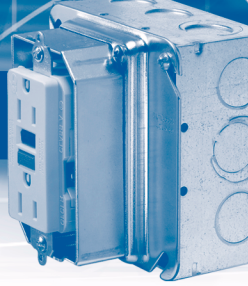

### Floor Mounted Box Supports

- Mounts on metal or wood studding
- Used as conduit rack or spacer for rigid conduit, IMC or EMT
- Ideal for schools, hospitals, industrial and commercial jobs
- Galvanized steel

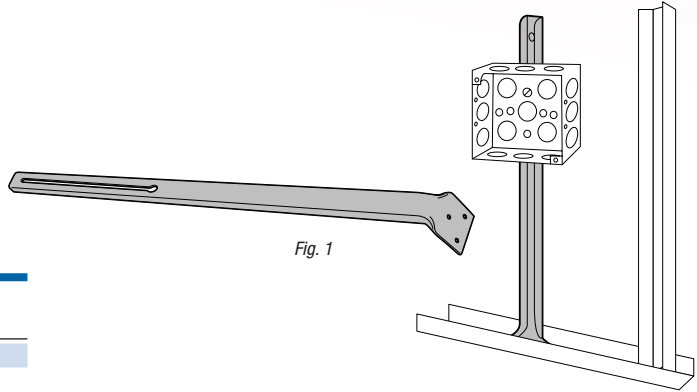

Fig. 1

CAT. NO.	FIG. NO.	DESCRIPTION	STD. CTN.
7502	1	Footed box supports, 20" height	25
7503-SC	1	Footed box supports, 30" height	50

### Old Work Box Support

- Quickly attaches box through finished drywall.
- For up to 1½" thick drywall.
- New 820D shipped in one piece break-apart design.
- Easy to install.

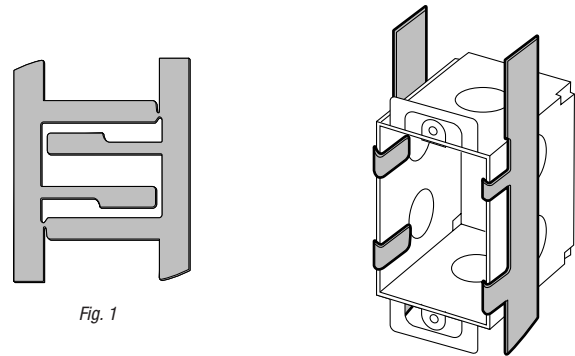

Fig. 1

CAT. NO.	FIG. NO.	DESCRIPTION	STD. CTN.
820D	1	Old work switch box steel mounting holder	100 sets

### Snap On Box Clip

- Fits most electrical boxes requiring plaster rings
- Fits most metal stud sizes
- Will not move on stud
- Wider part for more secure fastening
- No screws required
- Support leg braces box against stud
- Installs easily with a hammer

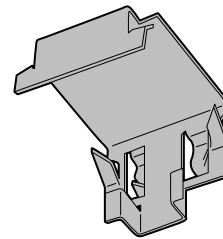
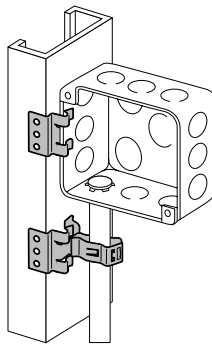

Fig. 1

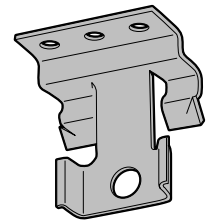

Fig. 2

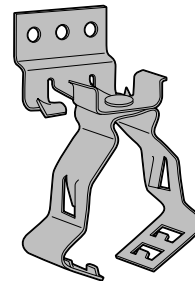

Fig. 3

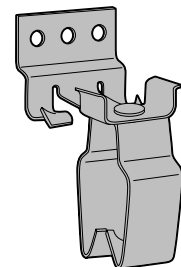

Fig. 4

CAT. NO.	FIG. NO.	DESCRIPTION	STD. CTN.
SSF-SMX	1	Snap on box support for mounting to stud	100
SSF-SK	2	Screw to stud, box support	100
SSF-SK-C1/2 3/4	3	½"-¾" finger close conduit clip	25
SSF-SK-C1	3	1" finger close conduit clip	25
SSF-SK-S1/2	4	½" snap-in conduit clip	25
SSF-SK-S3/4	4	¾" snap-in conduit clip	25
SSF-SK-S1	4	1" snap-in conduit clip	25



### Grounding Devices



GEE

#### Grounding Clip

- For grounding switch and outlet boxes using non-metallic sheathed cables with ground wire.
- Grounds #12 and #14 copper and #12 aluminum conductors.

#### Grounding Pigtail

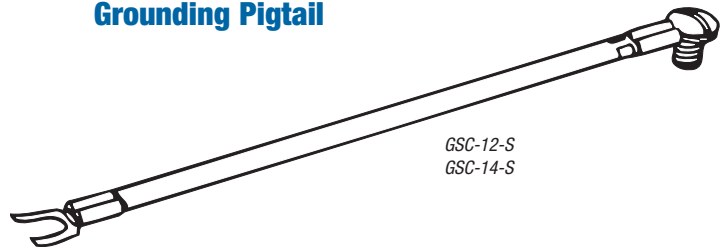

GSC-12-S  
GSC-14-S

#### Grounding Screw and Wire

- A prelooped 6" long bare or insulated copper ground wire attached to a 10-32 x 3/8" hexagon head washer face screw, colored green.

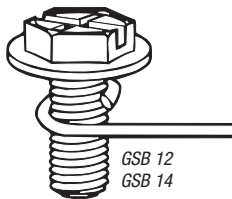

GSB 12  
GSB 14

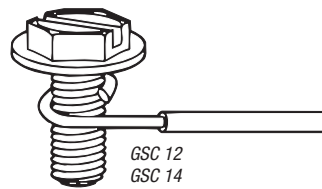

GSC 12  
GSC 14

#### Grounding Screw

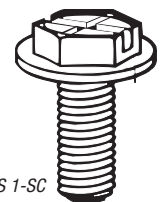

GS 1-SC

CAT. NO.	DESCRIPTION	STD. CTN.	UNIT PKG.
<b>Grounding Clip</b>			
GEE	Zinc plated, spring steel, colored green Accommodates #12 and #14 copper and #12 aluminum solid conductors in non-metallic sheathed cable. Also approved for connecting bonding jumper from receptacle to grounded metal device box. 50 per unit package.	1,000	—
<b>Grounding Screws and Pigtails</b>			
GSC 12	10-32 x 3/8" slotted hexagon head washer face ground screw with green dye finish and a six inch solid copper #12 AWG insulated wire.	1,000	100
GSC-12-S*	#12 AWG insulated eight inch stranded pigtail with a captive 10-32 x 3/8" round head screw on one end and a fork tongue terminal on the other end.	1,000	100
GSC-12-10 1/2	10-32 x 3/8" slotted hexagon head washer face ground screw with green dye finish and a 10 1/2 inch solid copper #12 AWG insulated wire.	1,000	100
GSC 14	10-32 x 3/8" slotted hexagon head washer face ground screw with green dye finish and a six inch solid copper #14 AWG insulated wire	1,000	100
GSC 14 S*	#14 AWG insulated eight inch stranded pigtail with a captive 10-32 x 3/8" round head screw on one end and a fork tongue terminal on the other end.	1,000	100
GSB 12	10-32 x 3/8" slotted hexagon head washer face ground screw with green dye finish and a six inch solid copper #12 AWG bare wire.	1,000	100
GSB 14	10-32 x 3/8" slotted hexagon head washer face ground screw with green dye finish and a six inch solid copper #14 AWG bare wire.	1,000	100
GS 1-SC	10-32 x 3/8" slotted hexagon head washer face screw with green dye finish. Provides positive ground continuity in boxes with a #10-32 tapped hole.	1,000	100

\* Eight inch stranded pigtail is also available with a captive 10-32 x 3/8" round head screw on one end and a fork tongue terminal on the other end.

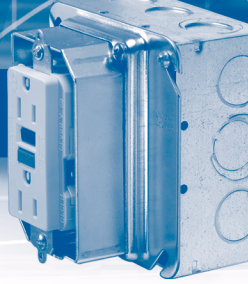

### Channel Bar

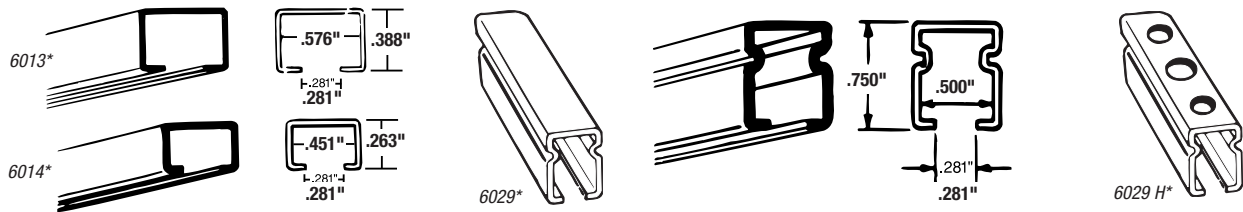

CAT. NO.	DESCRIPTION	MIN. ORDER (FT.)	STD. CTN.
<b>Mounts Fixtures, Boxes and Conduits in Suspended Ceilings</b>			
6013*	20 ga. single channel bar	100	100
6014*	18 ga. single channel bar	100	100
6029*	16 ga. (.060") ribbed	100	100
6029 H*	16 ga. (.060") ribbed — with holes for #12 sheet metal screw and 1/4" threaded rod	100	100

\*10-ft. lengths.

### Box Supports

CAT. NO.	DESCRIPTION	STD. CTN.
<b>Side Support</b>		
SS 1-TB	Side support prevents the box from falling back into the wall when installing devices; designed as standard for 3/8" metal studs; can be adapted for 1 1/8", 2 1/2", and 4", and metal studs	500

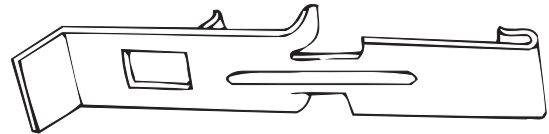

SS 1-TB

### Box and Channel Fasteners

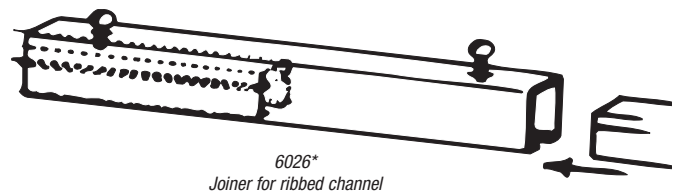
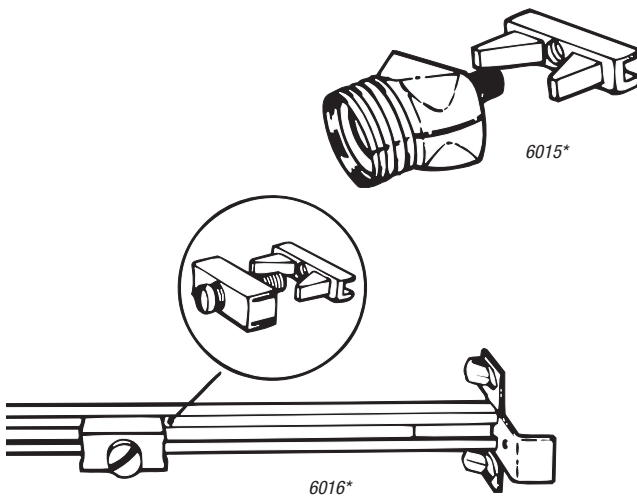

6026\*  
Joiner for ribbed channel

CAT. NO.	DESCRIPTION	MIN. ORDER (FT.)	STD. CTN.
6015*	Stud and carrier 3/8"-18 NPS threading	100	100
6016*	Fastener and carrier	100	100
6026*	Joiner for 6029 channel	100	100

\* Minimum order 100 pieces.

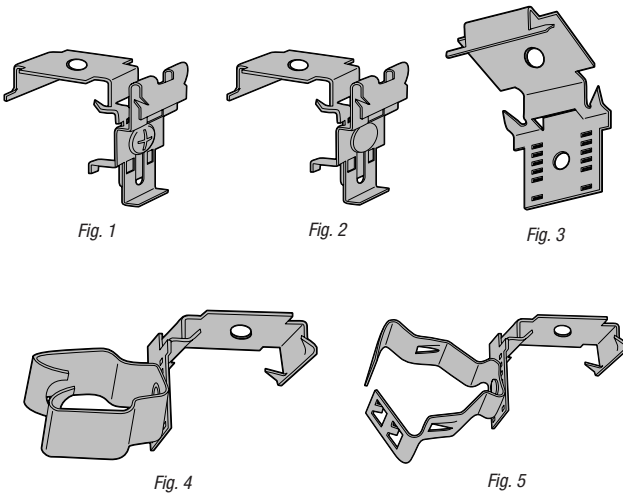
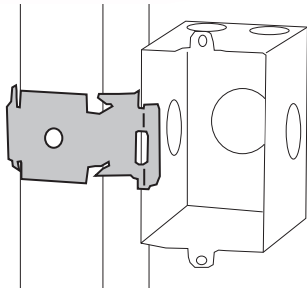

### Switch Box or Conduit to Metal Stud

- Attaches securely to most metal stud sizes
- Adjustable offset allows the box to protrude through drywall sizes: 1/4", 3/8", 1/2", 5/8" or 3/4"
- Riveted to accommodate your drywall requirements

CAT. NO.	FIG. NO.	DESCRIPTION	STD. CTN.
SSF-SFA	1	Snap on box support for mounting to stud, adjustable	25
SSF-SFO	2	Snap on box support for mounting to stud, riveted for flush to stud face	25
SSF-SF1/4	2	Snap on box support for mounting to stud, riveted for 1/4" drywall	25
SSF-SF3/8	2	Snap on box support for mounting to stud, riveted for 3/8" drywall	25
SSF-SF1/2	2	Snap on box support for mounting to stud, riveted for 1/2" drywall	25
SSF-SF5/8	2	Snap on box support for mounting to stud, riveted for 5/8" drywall	25
SSF-SF3/4	2	Snap on box support for mounting to stud, riveted for 3/4" drywall	25
SSF-SFT	3	Snap on box support for mounting to stud with 1/4"-20 thread impression	25
SSF-SF-S1/2	4	Snap on stud, push-in conduit clip, 1/2" conduit	25
SSF-SF-S3/4	4	Snap on stud, push-in conduit clip, 3/4" conduit	25
SSF-SF-S1	4	Snap on stud, push-in conduit clip, 1" conduit	25
SSF-SF-C3/8	5	Snap on stud, conduit support clip, 3/8" conduit or MC/AC cable	25
SSF-SF-C1/2 3/4	5	Snap on stud, conduit support clip, 1/2"-3/4" conduit	25
SSF-SF-C1	5	Snap on stud, conduit support clip, 1" conduit	25

SSF-SH2346  
Fig.1

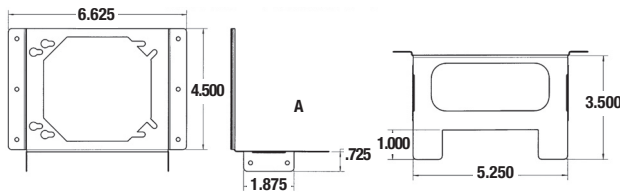

### Mounting Bracket

- Attaches 4" and 4 1/16" electrical boxes to metal stud
- Support leg can be attached to stud to eliminate movement of box in wall
- Attaches to metal or wood stud using self tapping screws and screw gun or nails
- One part mounts boxes for 1 1/2", 2 1/2", 3 1/2", 4" and 6" stud which means less inventory
- SH4, SH6, brackets available specifically for 4" and 6" studs respectively

Fig. 2

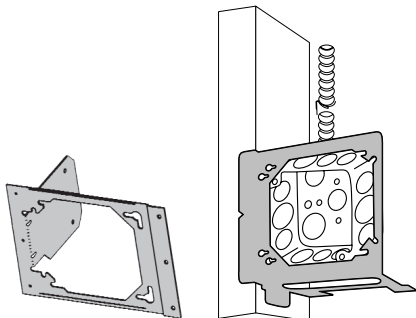

CAT. NO.	FIG. NO.	DESCRIPTION	STD. CTN.
SSF-SH2346	1	4" & 4 1/16" outlet boxes to 2 1/2", 3 1/2", 4" & 6" metal studs	100
SSF-SH4	2	4" & 4 1/16" outlet boxes to 4" metal studs	50
SSF-SH6	2	4" & 4 1/16" outlet boxes to 6" metal studs	50



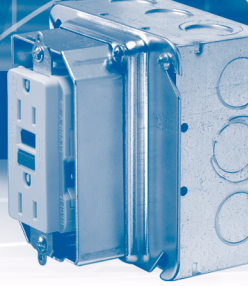

### Box Mounting Brackets for Between Studs

- Supports electrical boxes, plaster rings or low voltage devices from one bracket
- Accommodates 4" or 4<sup>1</sup>/<sub>16</sub>" boxes
- Bendable leg serves as a bracket stabilizer
- SB16F and SB24F flat versions allow mounting for any stud spacing, from 4" to 24"
- SB brackets allow box mounting in all four 90° orientations

CAT. NO.	FIG. NO.	DESCRIPTION	STD. CTN.
SSF-SB16	1	Box mounting bracket for between studs, 16" stud spacing	25
SSF-SB24	2	Box mounting bracket for between studs, 24" stud spacing	25
SSF-SB16F	3	Box mounting bracket, flat version, up to 16" stud spacing	25
SSF-SB24F	4	Box mounting bracket, flat version, up to 24" stud spacing	25

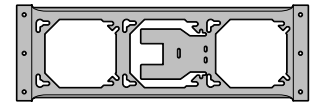
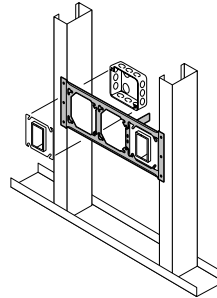

Fig. 1

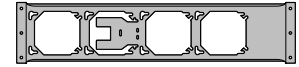

Fig. 2

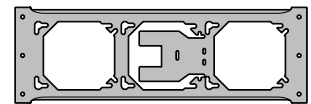

Fig. 3

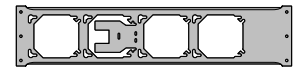

Fig. 4

### Screw Gun Box Bracket

- Self-tapping screws are aligned with the dimples so that the box is straight
- Allows mounting of multiple boxes
- Preset for metal stud 16" or 24" on center
- Depth set for 1<sup>1</sup>/<sub>2</sub>" or 2<sup>1</sup>/<sub>8</sub>" deep electrical box
- Installs easily with a screw gun
- SGP and SGA brackets have adjustetabs for 1<sup>1</sup>/<sub>2</sub>" or 2<sup>1</sup>/<sub>8</sub>" deep boxes
- SGA brackets adjustable for non-standard stud spacing

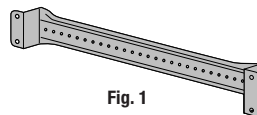
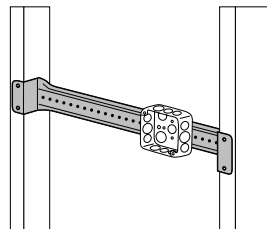

Fig. 1

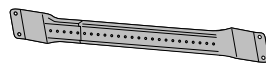

Fig. 2

CAT. NO.	FIG. NO.	DESCRIPTION	STUD SPACING	BOX DEPTH	STD. CTN.
SSF-SG16P	2	Preset box bracket	16"	1 <sup>1</sup> / <sub>2</sub> " or 2 <sup>1</sup> / <sub>8</sub> "	50
SSF-SG16A	3	Adjustable box bracket	11"-18"	1 <sup>1</sup> / <sub>2</sub> " or 2 <sup>1</sup> / <sub>8</sub> "	50
SSF-SG24P	2	Preset box bracket	24"	1 <sup>1</sup> / <sub>2</sub> " or 2 <sup>1</sup> / <sub>8</sub> "	50
SSF-SG24A	3	Adjustable box bracket	17"-26"	1 <sup>1</sup> / <sub>2</sub> " or 2 <sup>1</sup> / <sub>8</sub> "	50

### Extension Plate Bracket

- Improved bracket with bendable stabilizer leg for use on 2<sup>1</sup>/<sub>2</sub>" and 3<sup>1</sup>/<sub>2</sub>" metal studs
- Mounts outlet boxes 12" or 18" offset from either a metal stud track or a stud
- When mounted, drywall ring is brought to within 1/8" of drywall every time and will not bulge or break out drywall
- Mounts 4" or 4<sup>1</sup>/<sub>16</sub>" outlet boxes, 1<sup>1</sup>/<sub>2</sub>" or 2<sup>1</sup>/<sub>8</sub>" deep
- The SSF-S6X extender works with SSF-SV12, SSF-SV18, SSF-SB16 and SSF-SB24 to extend stabilizer leg when using 6" stud
- SV18 provides compliance with Americans with disabilities act (ADA) requirements

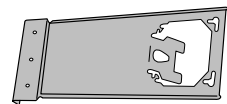
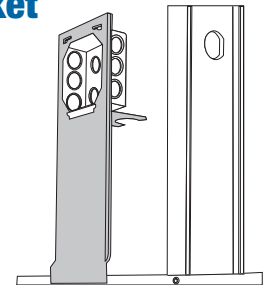
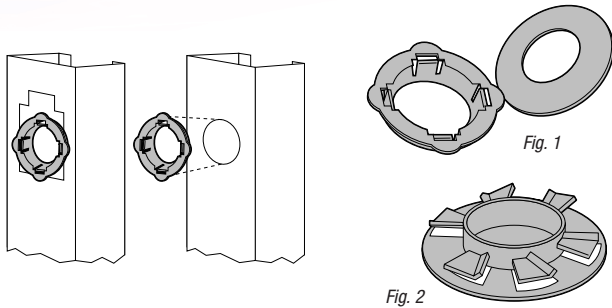

Fig. 1



Fig. 2

CAT. NO.	FIG. NO.	DESCRIPTION	STD. CTN.
SSF-SV12	1	Extension plate bracket, 12" height	50
SSF-SV18	1	Extension plate bracket, 18" height	50
SSF-S6X	2	Extender for 6" metal studs	100



### Easy Snap Grommet

- Fits any size or shape metal stud hole
- Provides complete 360° protection for cable

CAT. NO.	FIG. NO.	DESCRIPTION	STD. CTN.
1300	1	Plastic bushing for metal stud 1" trade size opening (1 <sup>1</sup> / <sub>2</sub> " )	100
1216-EN	2	Twisted universal bushing for metal stud	50

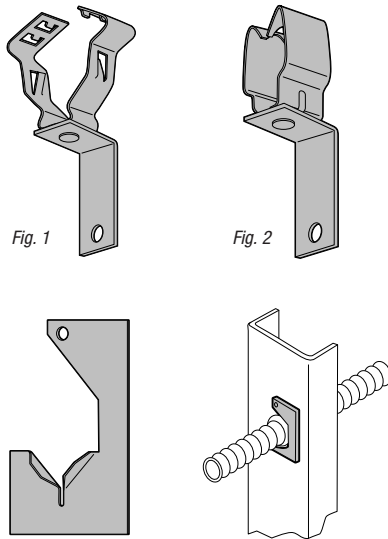

### Through Stud Cable Conduit Support

- A quick means of support for horizontal runs of conduits or MC/AC through metal stud
- Installs easily with a screw gun
- SSF-SPI allows ENT conduit and MC/AC cable to be easily pulled through metal stud

CAT. NO.	FIG. NO.	DESCRIPTION	STD. CTN.
SSF-SAB-C1/2 3/4	1	1/2" or 3/4" finger close conduit clip	25
SSF-SAB-C3/8	1	Finger close conduit clip 14-2 thru 12-3 MC/AC cable and 3/8" conduits	25
SSF-SAB-S1/2	2	Snap-in conduit clip — 1/2" conduit	25
SSF-SAB-S3/4	2	Snap-in conduit clip — 3/4" conduit	25
SSF-SP1	3	Supports up to 1" conduit	100

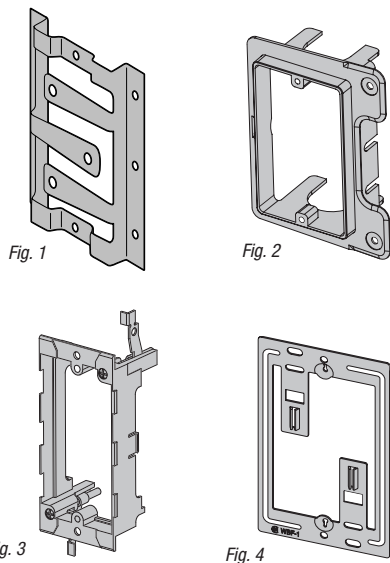

### Low Voltage Mounting Brackets — Screw on Support

- Eliminates the need for an electrical box when installing low voltage Class 2 wiring
- For old work or new work

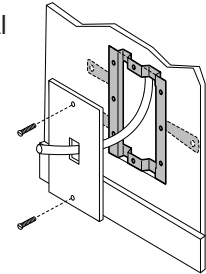

CAT. NO.	FIG. NO.	DESCRIPTION	STD. CTN.
SSF-SLV	1	Old work or new work low voltage bracket	100
VN1	2	Non-metallic single gang new work low voltage bracket	50
VN2	—	Non-metallic two gang new work low voltage bracket	50
VW1	3	Non-metallic single gang old work low voltage bracket	50
VW2	—	Non-metallic two gang old work low voltage bracket	50
WBF-1	4	Low voltage mounting bracket with screws	100

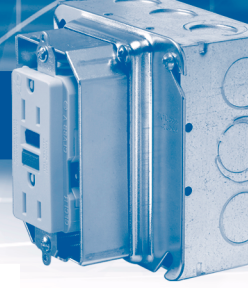

### Device Leveler and Retainer

- Use for oversized drywall openings
- Prevents broken cover plates
- Stops device from being pushed back in wall
- Makes floating device rigid

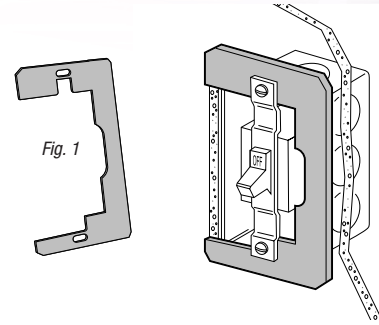

CAT. NO.	FIG. NO.	DESCRIPTION	STD. CTN.
SSF-SR	1	Single gang device leveler and retainer	100

### Protector Plates

- Protects cable(s) from damage when installing drywall or paneling
- No nails or screws required
- Fits all stud sizes
- Both products meet requirements for NEC 300-4½
- ST66 legs are crimped with pliers to stud to provide secure fit

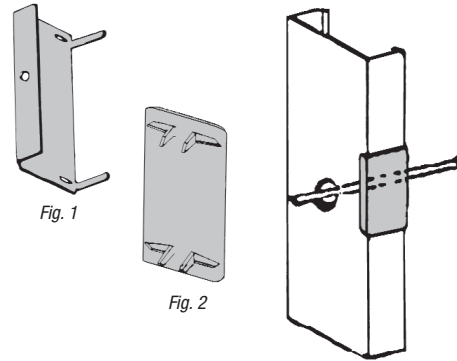

CAT. NO.	FIG. NO.	DESCRIPTION	STD. CTN.
SSF-ST66	1	Protector plate for metal stud	100
66EP-SC	2	Protector plate for wood stud	100

### Cable Support

- Supports up to 4 runs of MC and AC cable and up to 6 runs of nonmetallic sheathed cable
- Installs with nails or staple or sheet metal screws
- Complies with NEC 300-4d for all wood and metal studs
- Made with high strength plastic

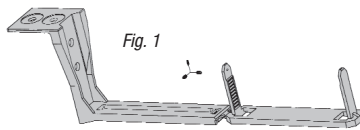

CABLE TYPE	CABLE SIZE	MAX. QTY./FASTENER
Non-metallic	14-2, 12-2, 10-2, 14-3	6
Sheathed cable	12-3 and 10-3 w/ground	4
Non-metallic	8-2 and 6-2 w/ground	4
Metallic clad	14-2, 12-2, 10-2, 14-3	4
(MC) cable and 10-4 w/ground	12-3, 10-3, 14-4, 12-4	4
Armored cable (AC)	14-4, 12-2, 10-2, 8-2	4
	14-3, 12-3, 10-3, 14-4	
	12-4 and 10-4 w/ground	
Flexible conduit (BX)	½", ¾"	4

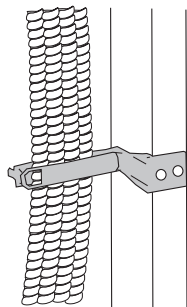

CAT. NO.	FIG. NO.	DESCRIPTION	STD. CTN.
SSF-SC6	1	Non-metallic sheathed MC/AC cable to stud clip	100

### Screw On Conduit Support

- Supports ½" and ¾" EMT conduit and MC/AC cable
- Works with wood or metal stud
- Preset bend provides alignment with knockouts for 1½" deep boxes or 2⅞" deep boxes

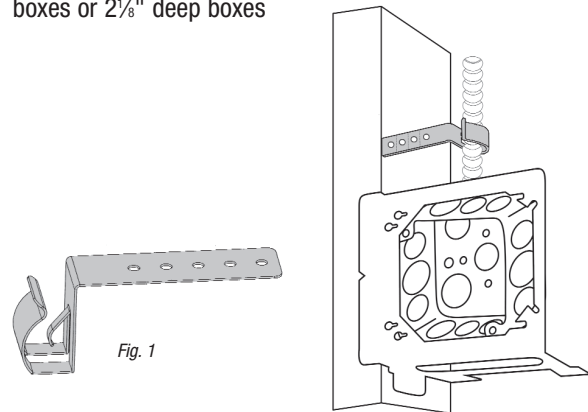

CAT. NO.	FIG. NO.	DESCRIPTION	STD. CTN.
SSF-SS1/2 3/4	1	½" and ¾" EMT conduit and MC/AC to metal or wood stud. For 1½" deep box.	100
SSF-SS1/2 3/4D	1	½" and ¾" EMT conduit, and MC/AC to metal or wood stud. For 2⅞" deep box.	100