

Maxcap[®] Double Layer Capacitors

Product Information & Application Data



Catalogue 11-B-1-3 09/07

Copyright Kanthal AB.

May be reproduced only with proper acknowledgement of the source.

This information, which may be subjected to change, is offered solely for your consideration and should not be taken as a warranty or representation for which we assume legal responsibility. It is not to be understood as permission or recommendation to utilise a patented invention without a licence and the user should determine whether relevant patents exist.

KANTHAL[®], GLOBAL[®] & MAXCAP[®] DLC are registered trademarks of Kanthal Group companies and other subsidiaries.

Kanthal Global
495 Commerce Drive
Ste 7
Amherst, NY 14228-2311
Toll Free: 877-GLOBAL-2 (877-456-2272)

Phone: 716-691-4010
Fax: 716-691-7850
e-mail: sales.global@kanthal.com
Internet: www.global.com

Form M-2004A - 09/07

Table of Contents

1. Product Overview	4
2. Product Summary-Selection Guide	6–7
3. Radial Leaded Products Dimensions/Electrical	
LP Series..	8
LC Series.	9
LK Series.....	10
LT Series.	11
LF Series	12
LV Series	13
LX Series.....	14
LJ Series.	15
Radial Leaded Specifications.....	16
4. Surface Mount Products	
LM Series, Dimensions/Electrical	17
Solder Reflow Recommendations.....	18
Land Pattern.....	18
LM Series Surface Mount Specifications	19
5. Electrical Characteristic Measurement Methods	20–22
6. Backup Time	
Minimum Backup Time Versus Initial Current for CMOS RAM.....	23
Voltage Versus Backup Time for Constant Resistance Loads	24–27
7. Charging Characteristics	28
8. Self Discharge Curves	29
9. Long Term Charging Curves	30
10. Electrical Characteristics Versus Temperature	31
11. Application Circuit Information	32
12. Application Notes	
Service Life	33
Polarity...	33
Cleaning Solutions	33
13. Use Beyond Rated Voltages	34–36
14. Operating Principle	37
15. Construction	38

Maxcap® Double Layer Capacitors Product Overview

**High Energy Density
Capacitors for Memory
Backup and Data
Transmission Power**

**New Surface Mount
Product Series**

**One Farad in a
0.65" x 0.75" Package**

**Up to 5.6 Farads in a
5.5 Volt Package**

**Up to 5.0 Farads in an
11.0 Volt Package**



Photo shows the 1.0 farad capacitor from each of the nine Maxcap DLC Series.

Maxcap® double layer capacitors are a new electric energy storage device with extremely high volumetric efficiency (over five farads/in³), virtually unlimited service life, fast charge/discharge capability and very low leakage current.

Pioneered by Sohio/Carborundum, the Maxcap DLC Product Line was purchased by Cesiwid in 1993. We changed our name to Kanthal Global in 1998.

A Maxcap DLC the size of a thimble will support microamp data retention currents of CMOS RAMs for up to several weeks, Microprocessors, small motors and activators having current requirements from one to several hundred milliamps can be supported from several seconds to minutes.

Conventional energy storage devices such as batteries and aluminum electrolytic capacitors often must be replaced during the life of a product.

Maxcap DLCs never need replacing because, unlike batteries, they do not undergo life-limiting, irreversible, chemical reactions, and, unlike aluminum electrolytic capacitors, they do not experience dry-up problems.

The high capacitance of Maxcap DLCs results from an electric double layer formed at the interface of high surface area activated carbon and a stable electrolyte. Unit cells are formed by separating two carbon/electrolyte wafers with an ionically conductive porous separator and sandwiching them between two electrically conductive, ionically impermeable membranes. The unit cells are stacked in series to achieve the desired capacitor voltage.

CAUTION: Due to their relatively high internal resistance, Maxcap DLCs should not be subjected to large ripple currents.

Key Features

Very high capacity in small size

Up to 100 times that of conventional capacitors. Circuit board space and equipment size can be reduced.

Useful voltage ratings

3.5 and 5.5 volt – Ideal for CMOS operating voltage range. 11 volt – LV Series, backup for relays, actuators, small motors.

Full range of sizes

From 0.01 to 5.6 farads @ 5.5 volts;
0.47, 1.0 and 5.0 farads @ 11 volts.

Surface Mount with LM Series

Low profile

with LP, LJ and LK Series

Ultra long life

Unlike batteries, Maxcap DLCs have no parasitic chemical reactions. They can be fully charged and discharged indefinitely. There is no “memory” effect.

Applications

Typical Maxcap DLC Backup Power Applications

Type of Load	Appliance or Equipment
CMOS; RAMS and microprocessors, Timers for Integrated Cicuits	Home appliances such as TVs, microwave ovens, dishwashers, and refrigerators; utility meters, personal computers, energy management controls, thermostats, point of sale terminals, process controllers, routers.
Relays, Solenoids	Starters, igniters, actuators
Small Motors, Alarms	Disc drives, coin metering devices, security systems, toys.
Data Transmission	Vehicle tracking systems, utility meters.

Product Summary – Selection Guide

Select from Nine Standard Product Series

The Maxcap DLC “Standard Products” offer a wide range of product geometries and electrical characteristics from which to choose. The major design considerations in selecting a Maxcap DLC for a given application include the load characteristic, the

allowable voltage drop, required backup time, and available board space.

To help you select the best Maxcap Double Layer Capacitor for your application, the table below summarizes the key features of each product series.

Maxcap DLC Standard Products Summary of Key Features and Electrical Characteristics



Series	LF (5.5 Volt)	LP (5.5 Volt)	LC (5.5 Volt)	LK (5.5 Volt)
Key Features	Very low ESR	Low height, low ESR	Reduced diameter, high energy density, low leakage current	Reduced height, high energy density, low leakage current
Typical Backup Application	For short time, high current (up to amps)	Days to weeks (microamps) For short time (milliamps)	Several weeks (microamps)	Several weeks (microamps)
Capacitance Range	0.047–1.5F	0.022–2.2F	0.022–1.0F	0.022–1.0F
ESR Range Maximum	0.6–14Ω	7–60Ω	35–220Ω	20–200Ω
ESR Range Typical	0.2–7Ω	5–80Ω	2–120Ω	1–20Ω
Typical* Long Charge Leakage Current	1–25µa	1–25µa	0.1–6µa	0.1–4µa
Operating Temperature	-25 to +70°C	-25 to +70°C	-25 to +70°C	-25 to +70°C

Ordering Information – Model Numbering System

LP	055	104	A
Maxcap DLC Product Series	Maximum working voltage 055 = 5.5VDC	Capacitance in μF . First two digits are sufficient figures, third digit is number of zeros to follow, e.g., 104 = 100,000	Capacitance tolerance +80% -20%

Epoxy End Seal Option: An epoxy end seal can be specified by adding “E” to the part number, e.g., LP055104AE. Capacitors with epoxy end seals are non-standard products



LT (5.5 Volt)	LV (11 Volt)	LX (5.5 Volt)	LJ (5.5 Volt)	LM (5.5 or 3.5 Volt)
Expanded temperature range, low leakage current	Increased voltage capability, low ESR	Our highest energy density product, low self discharge rate	Expanded temperature range, low ESR	Surface mount design, low self discharge
Several weeks (microamps)	For short time, high current, high voltage (up to milliamps)	Several weeks (microamps)	Several weeks (microamps) For short time (milliamps)	Several weeks (microamps)
0.022–1.0F	0.47, 1.0 & 5.0F	0.01–4.7F	0.1–5.6F	0.047–1.0F
60–220 Ω	4–7 Ω	35–300 Ω	0.6–16 Ω	7–50 Ω
5–120 Ω	0.8–5 Ω	0.5–60 Ω	0.2–10 Ω	3–18 Ω
0.1–4 μA	1–4 μA	0.7–15 μA	0.5–10 μA	0.5–10 μA
-40 to +85°C	-25 to +70°C	-25 to +70°C	-40°C to +85°C.	-25 to +70°C

*Charging current after 72 hours with 1000 Ω resistor in series with capacitor at 25°C, see pages 30 & 31.

Radial Leaded Products

Maxcap LP Series

Key Features

- **Low profile, low ESR**
- **One farad in 1.1" × 0.6" package**
- **Operating temperature**
-25°C to +70°C
- **Storage temperature**
-40°C to +85°C

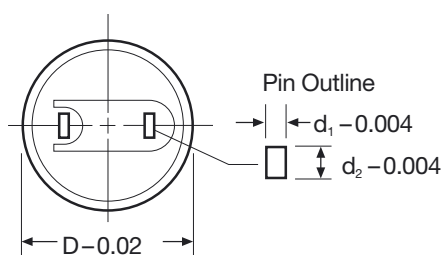
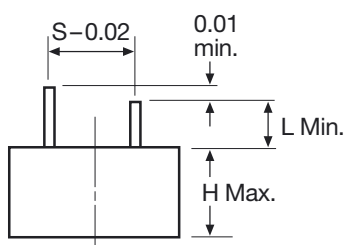
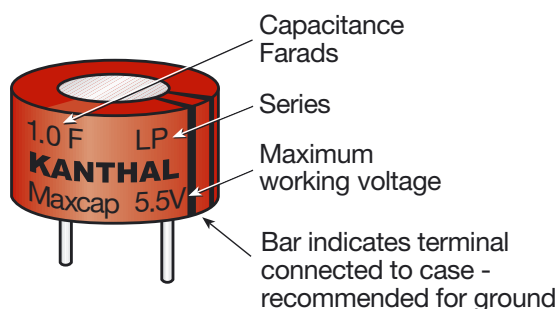

Maxcap DLC Standard Products

Electrical Characteristics

Part No.	Capacitance Farads	Maximum Working Voltage Volts, D.C.	Surge Voltage Volts, D.C.	Maximum ESR Ohms@ 1kHz	Typical ESR Ohms@ 1kHz	Maximum* Charging Current after 30 Minutes Milliamps	Weight Grams, Typical
LP055223A	0.022	5.5	6.3	60	10-20	0.033	1.6
LP055473A	0.047	5.5	6.3	40	7-14	0.071	2.6
LP055104A	0.1	5.5	6.3	25	4-10	0.15	4.1
LP055224A	0.22	5.5	6.3	25	5-10	0.33	5.3
LP055474A	0.47	5.5	6.3	13	2-5	0.71	10
LP055105A	1.0	5.5	6.3	7	1-3	1.50	18

Dimensions - Inches (mm)

Part No.	Capacitance Farads	Diameter D	Maximum Height H Max.	Pin Spacing S	Pin Outline d ₁ × d ₂	Pin Length L Min.
LP055223A	0.022	0.45 (11.5)	0.34 (8.5)	0.2 (5.1)	0.016×0.048 (0.4×1.2)	0.106 (2.7)
LP055473A	0.047	0.50 (12.5)	0.34 (8.5)	0.2 (5.1)	0.016×0.048 (0.4×1.2)	0.087 (2.2)
LP055104A	0.1	0.63 (16.0)	0.34 (8.5)	0.2 (5.1)	0.016×0.048 (0.4×1.2)	0.106 (2.7)
LP055224A	0.22	0.63 (16.0)	0.51 (13.0)	0.2 (5.1)	0.016×0.048 (0.4×1.2)	0.106 (2.7)
LP055474A	0.47	0.83 (21.0)	0.51 (13.0)	0.3 (7.6)	0.024×0.048 (0.6×1.2)	0.118 (3.0)
LP055105A	1.0	1.12 (28.5)	0.55 (14.0)	0.4 (10.2)	0.024×0.055 (0.6×1.2)	0.240 (6.1)

* For indication of long term charging current (typical leakage current), see pages 30 & 31.

Maxcap LC Series

Key Features

- **Small diameter**
- **Very high energy density**
One farad in 0.85" × 0.63"
Up to 2.2 farads in single package
- **Low self discharge rate**
- **Operating temperature** -25°C to +70°C
- **Storage temperature** -40°C to +85°C

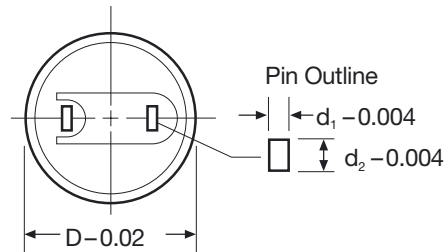
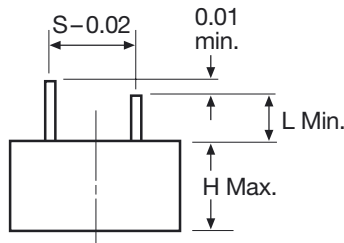
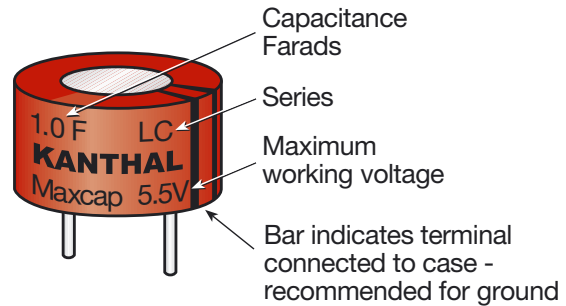

Maxcap DLC Standard Products

Electrical Characteristics

Part No.	Capacitance Farads	Maximum Working Voltage Volts, D.C.	Surge Voltage Volts, D.C.	Maximum ESR Ohms@ 1kHz	Typical ESR Ohms@ 1kHz	Maximum* Charging Current after 30 Minutes Milliamps	Weight Grams, Typical
LC055223A	0.022	5.5	6.3	220	40-80	0.033	1.6
LC055473A	0.047	5.5	6.3	220	40-80	0.071	1.7
LC055104A	0.10	5.5	6.3	100	20-40	0.15	2.4
LC055224A	0.22	5.5	6.3	120	20-50	0.33	4.3
LC055474A	0.47	5.5	6.3	65	10-25	0.71	6.0
LC055105A	1.0	5.5	6.3	35	5-15	1.5	11.0
LC055145A	1.4	5.5	6.3	45	5-20	2.1	12.1
LC055225A	2.2	5.5	6.3	35	5-15	3.3	23.1

Dimensions - Inches (mm)

Part No.	Capacitance Farads	Diameter D	Maximum Height H Max.	Pin Spacing S	Pin Outline d ₁ × d ₂	Pin Length L Min.
LC055223A	0.022	0.45 (11.5)	0.34 (8.5)	0.2 (5.1)	0.016 × 0.047 (0.4 × 1.2)	0.106 (2.7)
LC055473A	0.047	0.45 (11.5)	0.34 (8.5)	0.2 (5.1)	0.016 × 0.047 (0.4 × 1.2)	0.106 (2.7)
LC055104A	0.1	0.51 (13.0)	0.34 (8.5)	0.2 (5.1)	0.016 × 0.047 (0.4 × 1.2)	0.087 (2.2)
LC055224A	0.22	0.57 (14.5)	0.59 (15.0)	0.2 (5.1)	0.016 × 0.047 (0.4 × 1.2)	0.095 (2.4)
LC055474A	0.47	0.65 (16.5)	0.59 (15.0)	0.2 (5.1)	0.016 × 0.047 (0.4 × 1.2)	0.106 (2.7)
LC055105A	1.0	0.85 (21.5)	0.63 (16.0)	0.3 (7.6)	0.024 × 0.047 (0.6 × 1.2)	0.118 (3.0)
LC055145A	1.4	0.85 (21.5)	0.75 (19.0)	0.3 (7.6)	0.024 × 0.047 (0.6 × 1.2)	0.118 (3.0)
LC055225A	2.2	1.12 (28.5)	0.87 (22.1)	0.4 (10.2)	0.024 × 0.055 (0.6 × 1.4)	0.240 (6.1)

* For indication of long term charging current (typical leakage current), see pages 30 & 31.

Maxcap LK Series

Key Features

- **Low profile**
- **Very high energy density**
One farad in 1.12" × 0.44" package
- **Low self discharge rate**
- **Operating temperature**
-25°C to +70°C
- **Storage temperature**
-40°C to +85°C

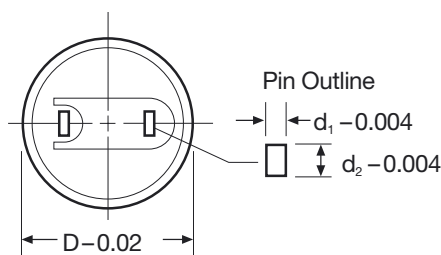
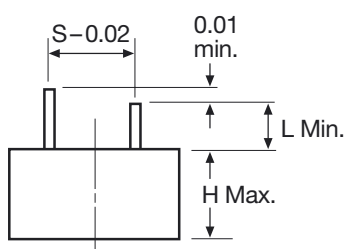
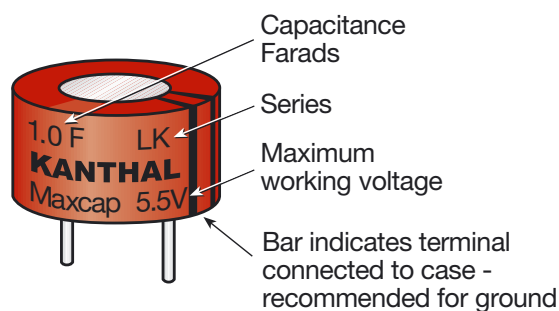

Maxcap DLC Standard Products

Electrical Characteristics

Part No.	Capacitance Farads	Maximum Working Voltage Volts, D.C.	Surge Voltage Volts, D.C.	Maximum ESR Ohms@ 1kHz	Typical ESR Ohms@ 1kHz	Maximum* Charging Current after 30 Minutes Milliamps	Weight Grams, Typical
LK055223A	0.022	5.5	6.3	200	80-120	0.033	1.5
LK055473A	0.047	5.5	6.3	100	20-40	0.071	2.1
LK055104A	0.1	5.5	6.3	50	10-25	0.15	3.3
LK055224A	0.22	5.5	6.3	60	10-25	0.33	3.7
LK055474A	0.47	5.5	6.3	35	5-15	0.71	7.1
LK055105A	1.0	5.5	6.3	20	2-7	1.50	13.7

Dimensions - Inches (mm)

Part No.	Capacitance Farads	Diameter D	Maximum Height H Max.	Pin Spacing S	Pin Outline d ₁ × d ₂	Pin Length L Min.
LK055223A	0.022	0.45 (11.5)	0.28 (7.0)	0.2 (5.1)	0.016×0.047 (0.4×1.2)	0.106 (2.7)
LK055473A	0.047	0.51 (13.0)	0.28 (7.0)	0.2 (5.1)	0.016×0.047 (0.4×1.2)	0.087 (2.2)
LK055104A	0.1	0.65 (16.5)	0.30 (7.5)	0.2 (5.1)	0.016×0.047 (0.4×1.2)	0.106 (2.7)
LK055224A	0.22	0.65 (16.5)	0.38 (9.5)	0.2 (5.1)	0.016×0.047 (0.4×1.2)	0.106 (2.7)
LK055474A	0.47	0.85 (21.5)	0.40 (10.0)	0.3 (7.6)	0.024×0.047 (0.6×1.2)	0.118 (3.0)
LK055105A	1.0	1.12 (28.5)	0.44 (11.0)	0.4 (10.2)	0.024×0.055 (0.6×1.4)	0.240 (6.1)

* For indication of long term charging current (typical leakage current), see pages 30 & 31.

Maxcap LT Series

Key Features

- **Expanded temperature range**
 Operating -40°C to $+85^{\circ}\text{C}$
 Storage -40°C to $+85^{\circ}\text{C}$
- **High energy density**
 One farad in $0.85'' \times 0.87''$ package

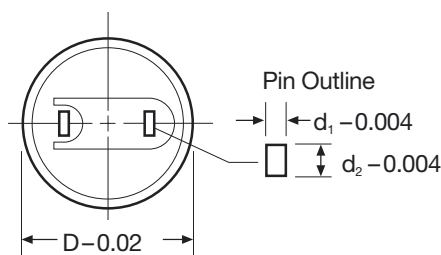
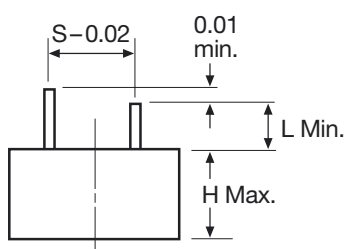
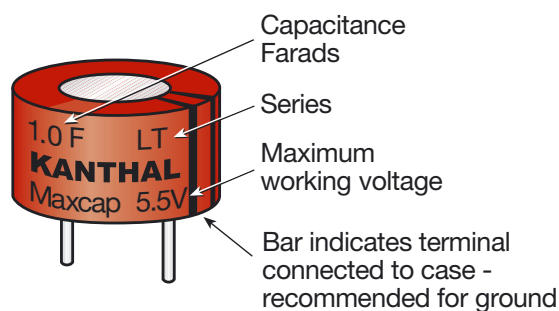

Maxcap DLC Standard Products

Electrical Characteristics

Part No.	Capacitance Farads	Maximum Working Voltage Volts, D.C.	Surge Voltage Volts, D.C.	Maximum ESR Ohms@ 1kHz	Typical ESR Ohms@ 1kHz	Maximum* Charging Current after 30 Minutes Milliamps	Weight Grams, Typical
LT055223A	0.022	5.5	6.3	220	80-120	0.033	2.3
LT055473A	0.047	5.5	6.3	110	20-50	0.071	3.9
LT055104A	0.1	5.5	6.3	150	20-50	0.15	4.3
LT055224A	0.22	5.5	6.3	180	25-60	0.33	5.3
LT055474A	0.47	5.5	6.3	100	10-25	0.71	7.5
LT055105A	1.0	5.5	6.3	60	5-15	1.50	13.3

Dimensions - Inches (mm)

Part No.	Capacitance Farads	Diameter D	Maximum Height H Max.	Pin Spacing S	Pin Outline $d_1 \times d_2$	Pin Length L Min.
LT055223A	0.022	0.45 (11.5)	0.55 (14.0)	0.2 (5.1)	0.016×0.047 (0.4×1.2)	0.106 (2.7)
LT055473A	0.047	0.57 (14.5)	0.55 (14.0)	0.2 (5.1)	0.016×0.047 (0.4×1.2)	0.095 (2.4)
LT055104A	0.1	0.57 (14.5)	0.61 (15.5)	0.2 (5.1)	0.016×0.047 (0.4×1.2)	0.095 (2.4)
LT055224A	0.22	0.57 (14.5)	0.83 (21.0)	0.2 (5.1)	0.016×0.047 (0.4×1.2)	0.095 (2.4)
LT055474A	0.47	0.65 (16.5)	0.85 (21.5)	0.2 (5.1)	0.016×0.047 (0.4×1.2)	0.106 (2.7)
LT055105A	1.0	0.85 (21.5)	0.87 (22.0)	0.3 (7.6)	0.016×0.047 (0.4×1.2)	0.118 (3.0)

* For indication of long term charging current (typical leakage current), see pages 30 & 31.

Maxcap LF Series

Key Features

- **Very low ESR**
As low as 0.3, typical
- **High energy density**
One farad in 1.44" × 0.73" package
Up to 1.5 farads in single package
- **Operating temperature**
-25°C to +70°C
- **Storage temperature**
-40°C to +85°C

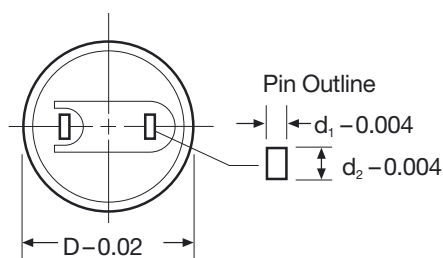
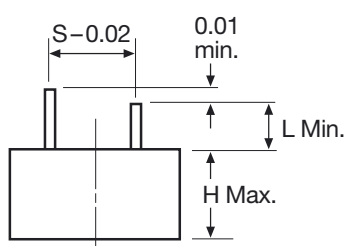
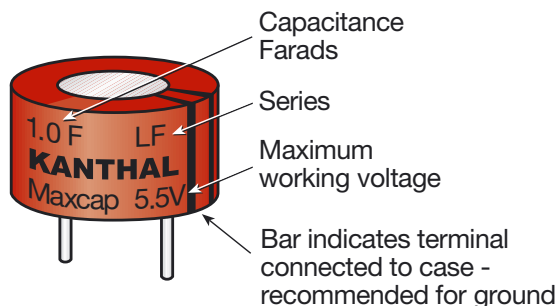

Maxcap DLC Standard Products

Electrical Characteristics

Part No.	Capacitance Farads	Maximum Working Voltage Volts, D.C.	Surge Voltage Volts, D.C.	Maximum ESR Ohms@ 1 kHz	Typical ESR Ohms@ 1 kHz	Maximum* Charging Current after 30 Minutes Milliamps	Weight Grams, Typical
LF055473A	0.047	5.5	6.3	14	4-7	0.071	3.8
LF055104A	0.1	5.5	6.3	6.50	2-4	0.15	4.8
LF055224A	0.22	5.5	6.3	3.5	1-3	0.33	9.7
LF055474A	0.47	5.5	6.3	1.8	0.5-1.0	0.71	16
LF055105A	1.0	5.5	6.3	1.0	0.3-0.6	1.50	38
LF055155A	1.5	5.5	6.3	0.6	0.2-0.4	2.3	72

Dimensions - Inches (mm)

Part No.	Capacitance Farads	Diameter D	Maximum Height H Max.	Pin Spacing S	Pin Outline d ₁ × d ₂	Pin Length L Min.
LF055473A	0.047	0.57 (14.5)	0.55 (14.0)	0.2 (5.1)	0.016 × 0.047 (0.4 × 1.2)	0.087 (2.2)
LF055104A	0.1	0.65 (16.5)	0.55 (14.0)	0.2 (5.1)	0.016 × 0.047 (0.4 × 1.2)	0.106 (2.7)
LF055224A	0.22	0.85 (21.5)	0.61 (15.5)	0.3 (7.6)	0.024 × 0.047 (0.6 × 1.2)	0.118 (3.0)
LF055474A	0.47	1.12 (28.5)	0.65 (16.5)	0.4 (10.2)	0.024 × 0.055 (0.6 × 1.4)	0.240 (6.1)
LF055105A	1.0	1.44 (36.5)	0.73 (18.5)	0.59 (15.0)	0.024 × 0.067 (0.6 × 1.4)	0.240 (6.1)
LF055155A	1.5	1.75 (44.5)	0.73 (18.5)	0.79 (20.0)	0.039 × 0.055 (1.0 × 1.40)	0.240 (6.1)

* For indication of long term charging current (typical leakage current), see pages 30 & 31.

Maxcap LV Series

Key Features

- **11 volts rating**
Up to 5 farads in single package
- **Low ESR**
- **Operating temperature**
-25°C to +70°C
- **Storage Temperature**
-40°C to -85°C

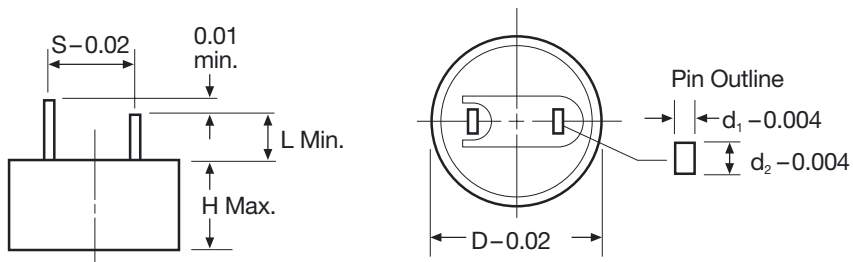
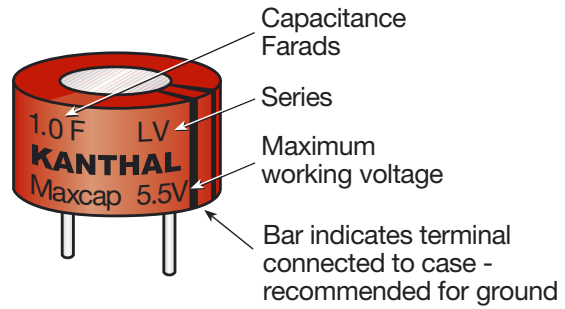

Maxcap DLC Standard Products

Electrical Characteristics

Part No.	Capacitance Farads	Maximum Working Voltage Volts, D.C.	Surge Voltage Volts, D.C.	Maximum ESR Ohms@ 1kHz	Typical ESR Ohms@ 1kHz	Maximum* Charging Current after 30 Minutes Milliamps	Weight Grams, Typical
LV110474A	0.047	11.0	12.6	7	2-5	1.41	23
LV110105A	1.0	11.0	12.6	7	1-3	3.0	33
LV110505A	5.0	11.0	12.6	4.0	0.8-2	18.0	160

Dimensions - Inches (mm)

Part No.	Capacitance Farads	Diameter D	Maximum Height H Max.	Pin Spacing S	Pin Outline d ₁ × d ₂	Pin Length L Min.
LV110474A	0.47	1.12 (28.5)	1.00 (25.5)	0.4 (10.2)	0.024 × 0.055 (0.6 × 1.4)	0.240 (6.1)
LV110105A	1.0	1.12 (28.5)	1.24 (31.5)	0.4 (10.2)	0.024 × 0.055 (0.5 × 1.4)	0.240 (6.1)
LV110505A	5.0	1.77 (44.8)	2.36 (60)	0.8 (20.0)	0.040 × 0.055 (1.0 × 1.4)	0.37 (9.5)

* For indication of long term charging current (typical leakage current), see pages 30 & 31.

Maxcap LX Series

Key Features

- **Our Highest Energy Density Product**
One farad in 0.65" x 0.75" package
Up to 4.7 farads in a single package
- **Small Diameter**
- **Low self discharge rate**
- **Operating temperature**
-25°C to +70°C
- **Storage temperature**
-40°C to +85°C

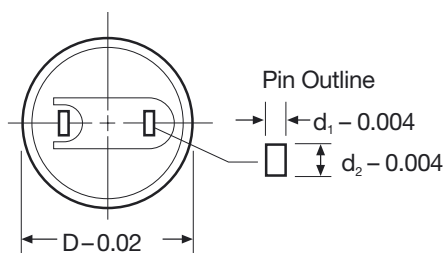
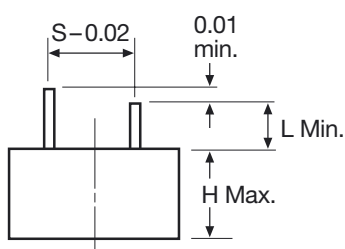
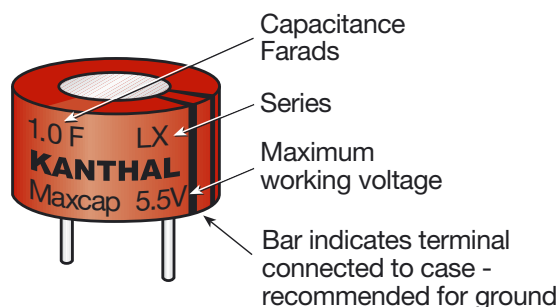

Maxcap DLC Standard Products

Electrical Characteristics

Part No.	Capacitance Farads	Maximum Working Voltage Volts, D.C.	Surge Voltage Volts, D.C.	Maximum ESR Ohms@ 1kHz	Typical ESR Ohms@ 1kHz	Maximum* Charging Current after 30 Minutes Milliamps	Weight Grams, Typical
LX055103A	0.01	5.5	6.3	300	20-60	0.015	0.9
LX055223A	0.022	5.5	6.3	200	10-50	0.033	1.0
LX055473A	0.047	5.5	6.3	200	10-50	0.071	1.0
LX055104A	0.1	5.5	6.3	100	5-40	0.15	1.3
LX055224A	0.22	5.5	6.3	100	4-30	0.33	2.5
LX055474A	0.47	5.5	6.3	120	10-50	0.71	5.1
LX055105A	1	5.5	6.3	65	3-20	1.5	7.0
LX055225A	2.2	5.5	6.3	35	1-10	3.3	12.1
LX055475A	4.7	5.5	6.3	35	0.5-8	7.1	27.3

Dimensions - Inches (mm)

Part No.	Capacitance Farads	Diameter D	Maximum Height H Max.	Pin Spacing S	Pin Outline d ₁ × d ₂	Pin Length L Min.
LX055103A	0.01	0.43 (11.0)	0.215 (5.5)	0.2 (5.1)	0.016 × 0.047 (0.4 × 1.2)	0.106 (2.7)
LX055223A	0.022	0.43 (11.0)	0.215 (5.5)	0.2 (5.1)	0.016 × 0.047 (0.4 × 1.2)	0.106 (2.7)
LX055473A	0.047	0.43 (11.0)	0.215 (5.5)	0.2 (5.1)	0.016 × 0.047 (0.4 × 1.2)	0.106 (2.7)
LX055104A	0.1	0.43 (11.0)	0.26 (6.5)	0.2 (5.1)	0.016 × 0.047 (0.4 × 1.2)	0.106 (2.7)
LX055224A	0.22	0.51 (13.0)	0.36 (9.0)	0.2 (5.1)	0.016 × 0.047 (0.4 × 1.2)	0.087 (2.2)
LX055474A	0.47	0.57 (14.5)	0.71 (18.0)	0.2 (5.1)	0.016 × 0.047 (0.4 × 1.2)	0.095 (2.4)
LX055105A	1	0.65 (16.5)	0.75 (19.0)	0.2 (5.1)	0.016 × 0.047 (0.4 × 1.2)	0.106 (2.7)
LX055225A	2.2	0.85 (21.5)	0.75 (19.0)	0.3 (7.6)	0.024 × 0.047 (0.6 × 1.2)	0.118 (3.0)
LX055475A	4.7	1.12 (28.5)	0.87 (22.0)	0.4 (10.2)	0.024 × 0.047 (0.6 × 1.2)	0.240 (6.1)

* For indication of long term charging current (typical leakage current), see pages 30 & 31.

Maxcap LJ Series

Key Features

- **Expanded temperature range**
Operating temperature -40°C to +85°C
Storage temperature -40°C to +85°C
- **Very high energy density with low ESR**
One farad in 0.85" D × 0.51" H package
Up to 5.6 farads in a single package
- **Low profile**
- **Low self discharge rate**

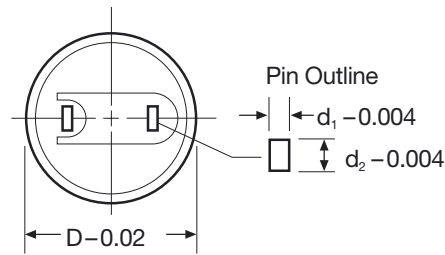
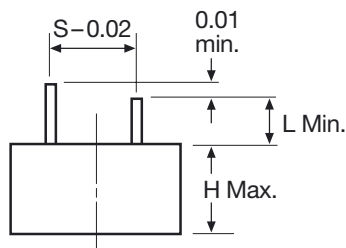
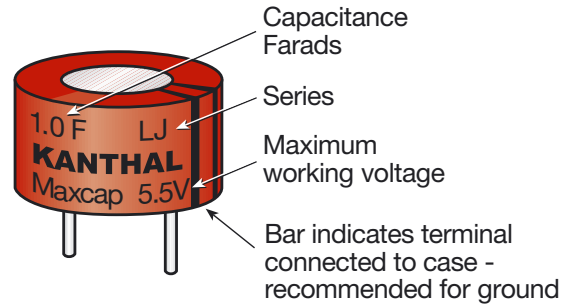

Maxcap DLC Standard Products

Electrical Characteristics

Part No.	Capacitance Farads	Maximum Working Voltage Volts, D.C.	Surge Voltage Volts, D.C.	Maximum ESR Ohms@ 1kHz	Typical ESR Ohms@ 1kHz	Maximum* Charging Current after 30 Minutes Milliamps	Weight Grams, Typical
LJ055104A	0.1	5.5	6.3	16	5-10	0.15	1.6
LJ055224A	0.22	5.5	6.3	10	4-8	0.33	4.1
LJ055474A	0.47	5.5	6.3	6.5	2-5	0.71	5.3
LJ055105A	1.0	5.5	6.3	3.5	1-3	1.5	10.0
LJ055225A	2.2	5.5	6.3	1.8	0.5-1	3.3	18.0
LJ055335A	3.3	5.5	6.3	1.0	0.3-0.7	5.0	38.0
LJ055565A	5.6	5.5	6.3	0.6	0.2-0.4	8.4	72.0

Dimensions - Inches (mm)

Part No.	Capacitance Farads	Diameter D	Maximum Height H Max.	Pin Spacing S	Pin Outline d ₁ × d ₂	Pin Length L Min.
LJ055104A	0.1	0.453 (11.5)	0.335 (8.5)	0.2 (5.1)	0.016 × 0.047 (0.4 × 1.2)	0.106 (2.7)
LJ055224A	0.22	0.57 (14.5)	0.47 (12.0)	0.2 (5.1)	0.016 × 0.047 (0.4 × 1.2)	0.087 (2.2)
LJ055474A	0.47	0.65 (16.5)	0.512 (13.0)	0.2 (5.1)	0.016 × 0.047 (0.4 × 1.2)	0.106 (2.7)
LJ055105A	1.0	0.85 (21.5)	0.512 (13.0)	0.3 (7.6)	0.024 × 0.047 (0.6 × 1.2)	0.118 (3.0)
LJ055225A	2.2	1.12 (28.5)	0.55 (14.0)	0.4 (10.2)	0.024 × 0.055 (0.6 × 1.4)	0.240 (6.1)
LJ055335A	3.3	1.44 (36.5)	0.59 (15.0)	0.6 (15.0)	0.024 × 0.067 (0.6 × 1.7)	0.240 (6.1)
LJ055565A	5.6	1.75 (44.5)	0.67 (17.0)	0.8 (20.0)	0.039 × 0.055 (1.0 × 1.4)	0.240 (6.1)

* For indication of long term charging current (typical leakage current), see pages 30 & 31.

Radial Leaded Products Specifications

Maxcap Double Layer Capacitor Specifications

Item	Test	Specifications	Capacitance	ESR
1. Capacitance	See test method, page 20.	*		
2. Capacitance Tolerance	-	+80%, -20%		
3. DC Maximum Working Voltage	-	5.5 VDC & 11.0 VDC		
4. Surge Voltage	Capacitors cycled from 0 → rated surge voltage → 0 volts 1000 times at max. operating temperature	6.3 VDC & 12.6 VDC	≥ 90%**	≤ 120%**
5. Equivalent Series Resistance (ESR)	See test method, page 22.	*		
6. Maximum Charging Current	See test method, page 22.	*		
7. Operating Temperature	See items 11, 12, and 13 below.	LC, LF, LK, LP, LV, LX Series: -25°C to +70°C LJ & LT Series: -40°C to +85°C		
8. Storage Temperature	See item 14 below	-40°C to +85°C		
9. Lead Strength	Pull test, 1 kg for 60 seconds	No breaks		
10. Solderability	Soldering temperature 230°C ± 5°C for 5 ± 0.5 seconds	Shall cover more than 75% of lead surface		
11. Thermal Stability	LC, LF, LK, LP, LV, LX Series: Capacitors cycled from +25°C (1) → -25°C (2) → +25°C (3) → +70°C (4) → +25°C (5)	Step 1 (+25°C)	*	*
		Step 2 (-25°C)	≥ 50%***	≤ +300%***
		Step 3 (+25°C)	+20%***	*
		Step 4 (+70°C)	≤ +150%***	*
		Step 5 (+25°C)	+20%***	*
	LJ & LT Series: Capacitors cycled from +25°C (1) → -40°C (2) → +25°C (3) → +85°C (4) → +25°C	Step 1 (+25°C)	*	*
		Step 2 (-40°C)	≥ 50%***	≤ +800%***
		Step 3 (+25°C)	+20%***	*
		Step 4 (+85°C)	≤ +150%***	*
		Step 5 (+25°C)	+20%***	*
12. Thermal Shock	Capacitors cycled 5 times with 30 minute exposure at each temperature with no voltage applied: LC, LF, LK, LP, LV, LX Series: +25°C → -40°C → +25°C → +70°C → +25°C LJ & LT Series: +25°C → 40°C → +25°C → +85°C → +25°C		*	*
			*	*
			*	*
			*	*
13. Life	Capacitors at rated temperature and voltage for 1000 hours: LC, LF, LK, LP, LV, LX Series: Test temperature 70°C		≥ 70%***	≥ +200%**
	LJ & LT Series: Test temperature 85°C		≥ 70%***	≥ +200%**
14. Storage Life	Capacitors at -40°C and +85°C for 500 hours each with no voltage applied		≥ 70%***	≥ +200%**
15. Humidity	Capacitors at 90 to 95% relative humidity at 40°C for 500 hours with no voltage applied		*	*
16. Resistance to Soldering Heat	Soldering temperature at 260°C ± 10°C for 10 ± 1 seconds		*	*
17. Vibration	Frequency 10–55 cycles/sec., 1.5 mm amplitude, 3 directions 2 hours each (total 6 hours)		*	*

*See "Standard Product" tables **% of values in "Standard Product" tables ***% of initial measured value
Note: Typical fa .

Surface Mount Products

Maxcap LM Series

Key Features

- **Surface Mount Design**
- **One Farad in 0.85" × 0.85" × 0.41" package**
- **Low self discharge rate**
- **5.5 volt or 3.5 volt operation**
- **Operating temperature**
-25°C to +70°C

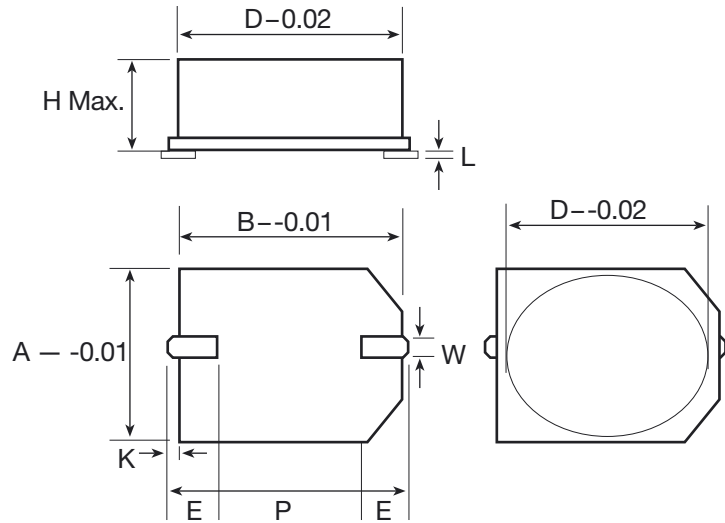

Maxcap DLC Standard Products

Electrical Characteristics

Part No.	Capacitance Farads	Maximum Working Voltage Volts, D.C.	Surge Voltage Volts, D.C.	Maximum ESR Ohms@ 1kHz	Typical ESR Ohms@ 1kHz	Maximum* Charging Current after 30 Minutes Milliamps	Weight Grams, Typical
LM055473A	0.047	5.5	6.3	50	10-18	0.071	1.0
LM055104A	0.1	5.5	6.3	25	8-16	0.15	1.0
LM055224A	0.22	5.5	6.3	25	6-14	0.33	1.0
LM055474A	0.47	5.5	6.3	13	3-8	0.71	3.9
LM055105A	1.0	5.5	6.3	7	3-6	1.50	6.8
LM035104A	0.1	3.5	4.0	50	10-25	0.090	1.0
LM035224A	0.22	3.5	4.0	25	6-14	0.20	1.0
LM035474A	0.47	3.5	4.0	25	6-14	0.42	1.0

Dimensions - Inches (mm)

Part No.	Capacitance Farads	Diameter D	Height H Max.	A	B	E	W	P	K	L Min.
LM055473A	0.047	0.41 (10.5)	0.22 (5.5)	0.43 (10.8)	0.43 (10.8)	0.14 (3.6)	0.047 (1.2)	0.2 (5.0)	0.028 (0.7)	0.008 (0.2)
LM055104A	0.1	0.41 (10.5)	0.22 (5.5)	0.43 (10.8)	0.43 (10.8)	0.14 (3.6)	0.047 (1.2)	0.2 (5.0)	0.028 (0.7)	0.008 (0.2)
LM055224A	0.22	0.41 (10.5)	0.34 (8.5)	0.43 (10.8)	0.43 (10.8)	0.14 (3.6)	0.047 (1.2)	0.2 (5.0)	0.028 (0.7)	0.008 (0.2)
LM055474A	0.47	0.63 (16.0)	0.37 (9.5)	0.64 (16.3)	0.64 (16.3)	0.27 (6.8)	0.047 (1.2)	0.2 (5.0)	0.047 (1.2)	0.015 (0.38)
LM055105A	1.0	0.83 (21.0)	0.41 (10.5)	0.85 (21.6)	0.85 (21.6)	0.28 (7.0)	0.055 (1.4)	0.39 (10.0)	0.047 (1.2)	0.015 (0.38)
LM035104A	0.1	0.41 (10.5)	0.22 (5.5)	0.43 (10.8)	0.43 (10.8)	0.14 (3.6)	0.047 (1.2)	0.2 (5.0)	0.028 (0.7)	0.008 (0.2)
LM035224A	0.22	0.41 (10.5)	0.22 (5.5)	0.43 (10.8)	0.43 (10.8)	0.14 (3.6)	0.047 (1.2)	0.2 (5.0)	0.028 (0.7)	0.008 (0.2)
LM035474A	0.47	0.41 (10.5)	0.34 (8.5)	0.43 (10.8)	0.43 (10.8)	0.14 (3.6)	0.047 (1.2)	0.2 (5.0)	0.028 (0.7)	0.008 (0.2)

* For indication of long term charging current (typical leakage current), see pages 30 & 31.

LM Series Solder Reflow Recommendations

The LM Series capacitor is designed for use in Infrared or Vapor Phase Convection solder reflow processes. The chart at right indicates typical time-temperature conditions for these processes.

Recognizing that a wide range of time and temperature conditions is possible depending on each manufacturer's circumstances, it is recommended that manufacturers adhere to the following general process guideline:

MaxCap DLC peak temperature at the top surface of the capacitor should be limited to 235°C for less than 10 seconds.

Adherence to this guideline should enable successful processing and allow for normal variation in time and temperature for most customer processes.

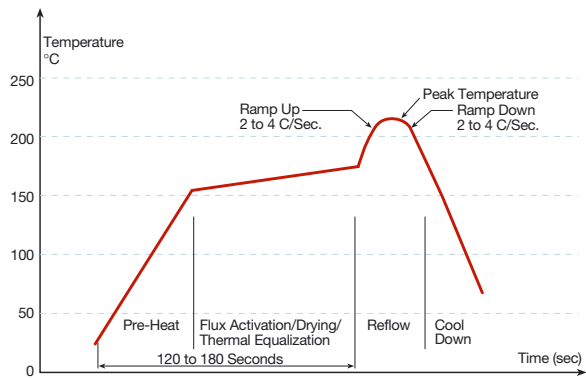

Typical Solder Reflow Time - Temperature Profile

Please consult the factory with questions regarding your specific process conditions.

Maxcap LM Series Recommended Land Pattern

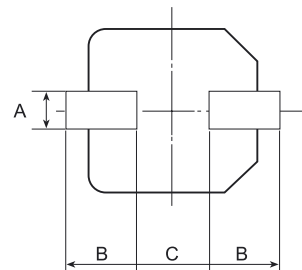

Dimensions - Inches (mm)

Part No.	A	B	C
LM055474A	0.10 (2.5)	0.18 (4.6)	0.2 (5.0)
LM055104A	0.10 (2.5)	0.18 (4.6)	0.2 (5.0)
LM055224A	0.10 (2.5)	0.18 (4.6)	0.2 (5.0)
LM055474A	0.10 (2.5)	0.39 (10.0)	0.2 (5.0)
LM055105A	0.14 (3.5)	0.41 (10.5)	0.4 (10.0)
LM035104A	0.10 (2.5)	0.18 (4.6)	0.2 (5.0)
LM035224A	0.10 (2.5)	0.18 (4.6)	0.2 (5.0)
LM035474A	0.10 (2.5)	0.18 (4.6)	0.2 (5.0)

Surface Mount Specifications

Electrical Measurements

Item	Test	Specifications	Capacitance	ESR
1. Capacitance	Discharge Test Method	*		
2. Capacitance Tolerance	–	+80%, -20%		
3. DC Maximum Working Voltage	–	5.5 VDC & 3.5 VDC		
4. Surge Voltage	Capacitors cycled from 0 → rated surge voltage through charge resistor → 0 volts 1000 times at max. operating temperature	6.3 VDC & 4.0 VDC (3.5 V products)	≥ 90%**	≤ 120%**
5. Equivalent Series Resistance (ESR)	See test method, page 22	*		
6. Maximum Charging Current	See test method, page 22.	*		
7. Operating Temperature	See items 8, 9, and 10 below.	-25°C to +70°C		
8. Thermal Stability	Capacitors cycled from +25°C (1) → -25°C (2) → +25°C (3) → +70°C (4) → +25°C (5)	Step 1 (+25°C) Step 2 (-25°C) Step 3 (+25°C) Step 4 (+70°C) Step 5 (+25°C)		
9. Thermal Shock	Capacitors cycled 5 times with 30 minute exposure at each temperature with no voltage applied: +25°C → -40°C → +25°C → +70°C → +25°C		*	*
10. Life	Capacitors at rated temperature and voltage for 1000 hours: Test temperature 70°C		≥ 70%***	≥ +200%**
11. Humidity	Capacitors at 90 to 95% relative humidity at 40°C for 500 hours with no voltage applied		*	*
12. Resistance to Soldering Heat	Temperature at 260°C ± 10°C for 10 ± 1 seconds*		*	*
13. Vibration	Frequency 10–55 cycles/sec., 1.5 mm amplitude, 3 directions 2 hours each (total 6 hours)		*	*

* See "Standard Product" tables ** % of values in "Standard Product" tables *** % of initial measured value

Electrical Characteristic Measurement Methods

I. Capacitance Charge Method:

Capacitance in farads can be calculated by using the formula and charging test circuit in Figure 1:

- a. Test temperature – Capacitors to be at $+25^{\circ} \pm 5^{\circ}\text{C}$.
- b. Initial capacitor voltage to be less than 0.05V.
- c. V_c = Volt meter (DC).
- d. $E_0 = 5.0 + 0.1V$ for LC, LF, LK, LP, LT, LX, LJ Series; LV Series: $10.0 + 0.1V$ for 11 V Rating. $12.0 + 0.1V$ for 12 V Rating.
- e. T = Charging time constant, that is, the time period in seconds from 0 to reach $0.632 \times E_0$ volts.
- f. R_c = Charging resistor selected from the table below:

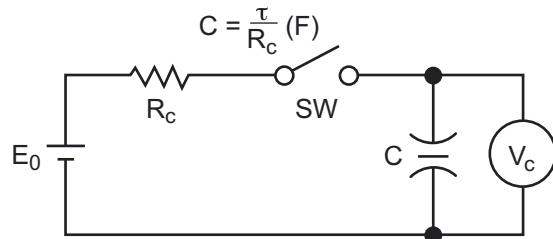

Figure 1. Capacitance – Charge Method

	LP SERIES	LC SERIES	LK SERIES	LT SERIES	LF SERIES	LV SERIES	LX SERIES	LJ SERIES
0.01 F	—	—	—	—	—	—	5 k Ω	—
0.022 F	1 k Ω	2 k Ω	2 k Ω	2 k Ω	1 k Ω	—	2 k Ω	—
0.047 F	1 k Ω	2 k Ω	1 k Ω	1 k Ω	1 k Ω	—	2 k Ω	—
0.1 F	510 Ω	510 Ω	1 k Ω	1 k Ω	510 Ω	—	1 k Ω	510 Ω
0.22 F	200 Ω	510 Ω	510 Ω	510 Ω	200 Ω	—	1 k Ω	200 Ω
0.47 F	100 Ω	200 Ω	200 Ω	200 Ω	100 Ω	100 Ω	1 k Ω	100 Ω
1.0 F	100 Ω	100 Ω	100 Ω	100 Ω	100 Ω	100 Ω	510 Ω	100 Ω
1.4 F	—	200 Ω	—	—	—	—	—	—
1.5 F	—	—	—	—	51 Ω	—	—	—
2.2 F	—	100 Ω	—	—	—	—	200 Ω	51 Ω
3.3 F	—	—	—	—	—	—	—	51 Ω
4.7 F	—	—	—	—	—	—	100 Ω	—
5.0 F	—	—	—	—	—	100 Ω	—	—
5.6 F	—	—	—	—	—	—	—	20 Ω

2. Discharge Method LM Series – 5.5V & 3.5V Products

Capacitance in farads is calculated by using the formula and discharging test circuit in Figure 2:

- a. Test temperature – Capacitors to be at $+25^{\circ} \pm 5^{\circ}\text{C}$.
- b. V_c = Volt meter (DC).
- c. $E_0 = 5.5\text{V}$ or 3.5V ; I = Current (amps);
 T = Time (seconds)
- d. A_L = Constant Current Load Device
- e. Initial capacitor voltage to be less than 0.05V .
- f. Begin charging capacitor to rated voltage (5.5V OR 3.5V). When the capacitor terminal voltage reaches the rated voltage, continue charging for another 30 minutes. 1.0F capacitors should be charged for 60 minutes.
- g. Discharge the capacitor with A_L (Constant Current Load Device) at a load of 1.0ma per 1.0 Farad. For example, a 0.47F capacitor will be discharged at a current of 0.47ma .
- h. Measure the time for the terminal voltage to fall from 3.0V to 2.5V for the 5.5V rated products and from 1.8V to 1.5V for the 3.5V rated products.
- i. Calculate capacitance in farads using the equation in Figure 3.

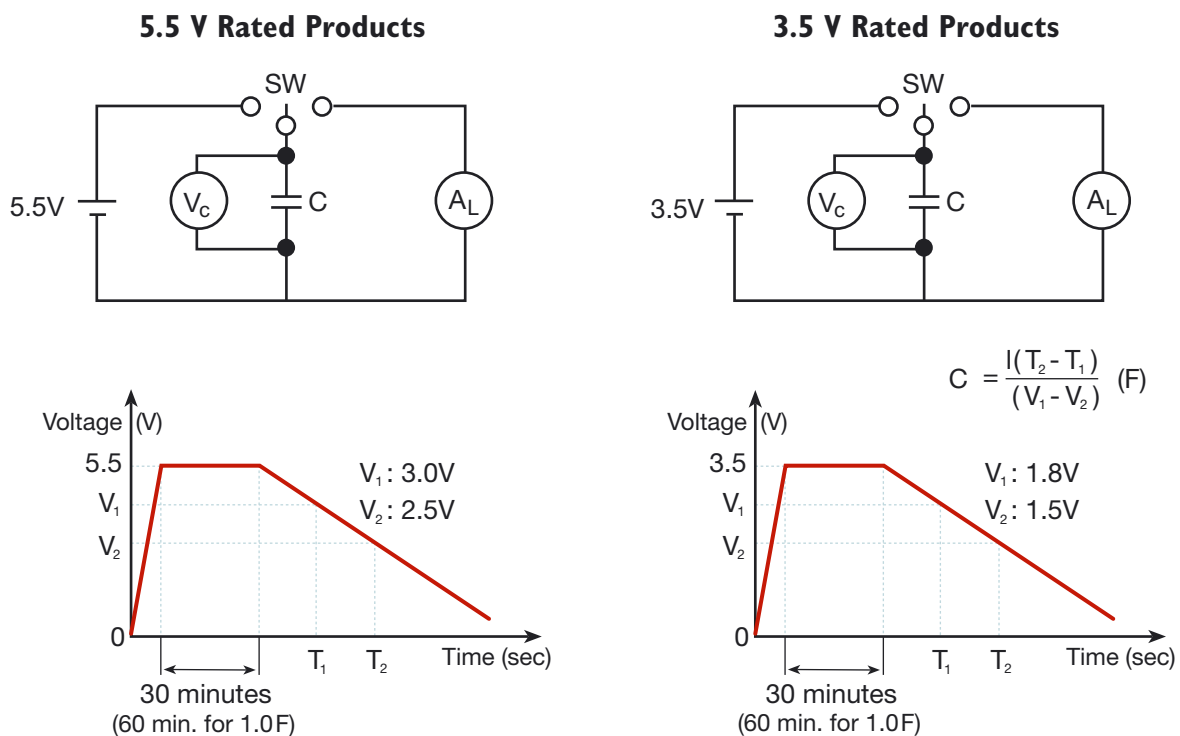

Figure 2. — Discharge Method – LM Series (Surface Mount)

3. Equivalent Series Resistance (ESR)

ESR in ohms can be measured using the test circuit in Figure 3:

- Test temperature and tolerance – Capacitor to be at $+25^{\circ}\text{C} \pm 5^{\circ}\text{C}$.
- Test frequency – $1,000 \pm 100$ Hz.
- The magnitude of the AC voltage to be limited to 0.5 volt rms maximum.
- A = Ampere meter (AC).
- V_c = Volt meter (AC)

Note: Volt meter impedance to be significantly higher than that of the capacitor.

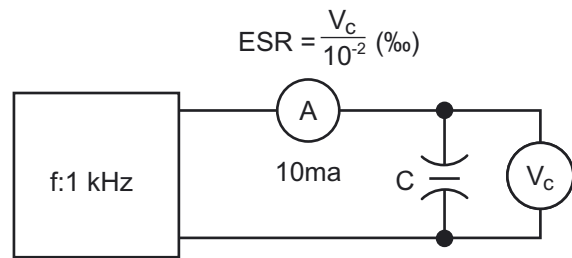

Figure 3. Equivalent Series Resistance (ESR)

4. DC Leakage Current (Charging Current – 30 Minute)

DC leakage current or charging current is measured using the test circuit and procedure in Figure 4:

- Test temperature and tolerance – Capacitors to be at $+25^{\circ}\text{C} \pm 5^{\circ}\text{C}$.
- Initial capacitor voltage to be less than 0.05V.
- V_c – Volt meter (DC).
- E_0 = Same voltage as used in capacitance measurement method.
- VR = Voltage drop by resistance R_c after 30 minutes on charge.
- R_c = Charging resistors selected from the table below:

0.01 – 0.047F	1000Ω
0.1 – 0.47F	100Ω
1.0 – 5.6F	10Ω

LV Series

0.47 & 1.0F	100Ω
5.0F	10Ω

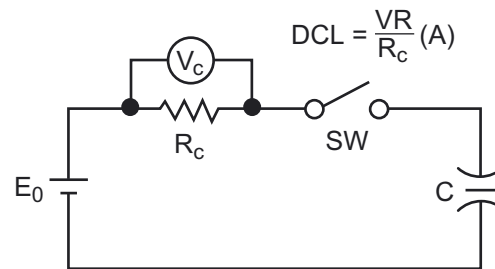

Figure 4. DC Leakage Current (Charging Current – 30 Minute)

Backup Time

Minimum Backup Time Capability

The following curves indicate the discharge times for Maxcap DLCs through constant resistance loads after charging for 24 hours at 5.0 volts.

Figures 5 and 6 show minimum backup time for a voltage range of from 5 to 2 volts, the typical data retention range for CMOS RAMs.

The actual backup time will be longer than indicated because the current draw of CMOS RAMs over the data retention voltage is somewhat less than that of constant resistance loads even though the initial current is the same.

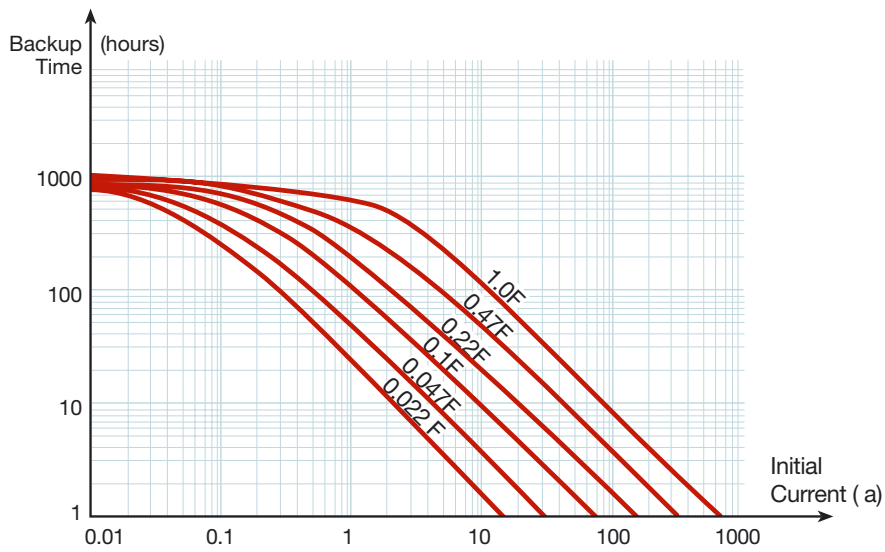

Figure 5. Minimum Backup Time Versus Initial Current for CMOS RAM Applications Using Maxcap DLC LP and LF Series from 5 to 2 Volts at 25°C

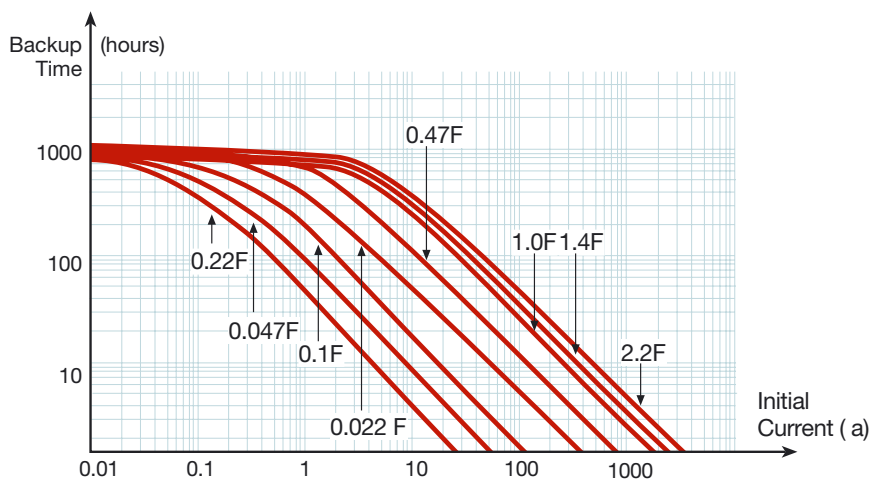

Figure 6. Minimum Backup Time Versus Initial Current for CMOS RAM Applications Using Maxcap DLC LC, LK, LX, LJ and LT Series from 5 to 2 Volts at 25°C

Note: Figure 5 and 6 curves are based on discharge times of Maxcap DLCs through constant resistance loads. Initial current is the load current at 5.0 volts.

Maxcap DLC Backup Times at 25°C for Constant Resistance Loads

Figures 7 through 40 show voltage versus backup time for a number of constant resistance loads for LC, LK, LT and LV Series capacitors after charging for 24 hours at 5.0 or 10 volts.

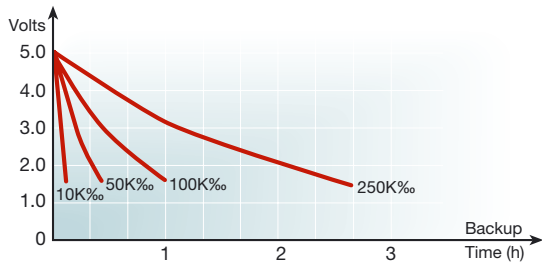

Figure 7. 0.022F – LC, LK, LT, LX Series

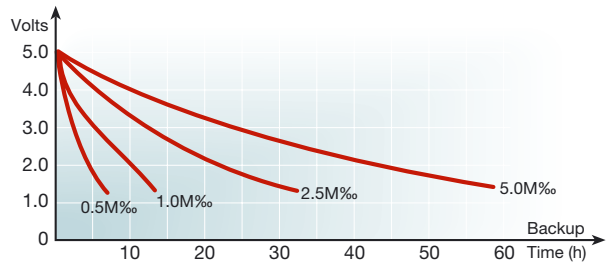

Figure 8. 0.022F – LC, LK, LT, LX Series

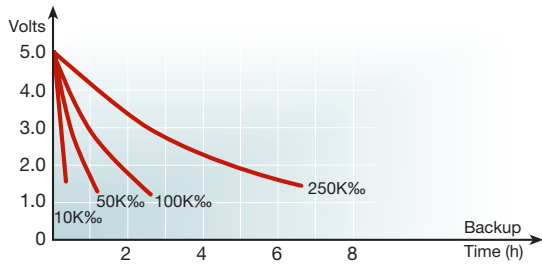

Figure 9. 0.047F – LC, LK, LT, LX, LJ, LM Series

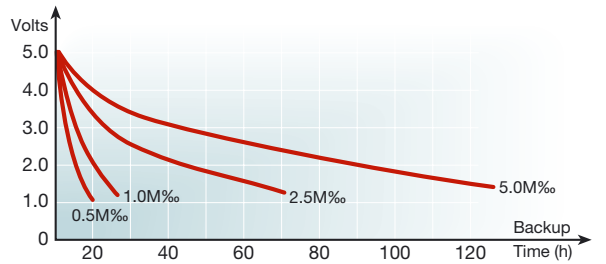

Figure 10. 0.047F – LC, LK, LT, LX, LJ, LM Series

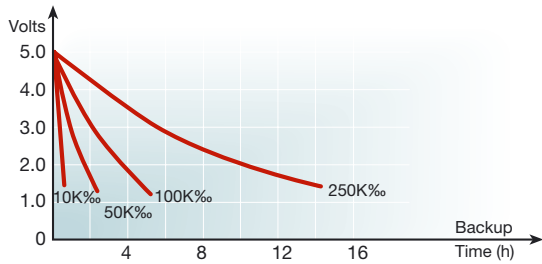

Figure 11. 0.1F – LC, LK, LT, LX, LJ, LM Series

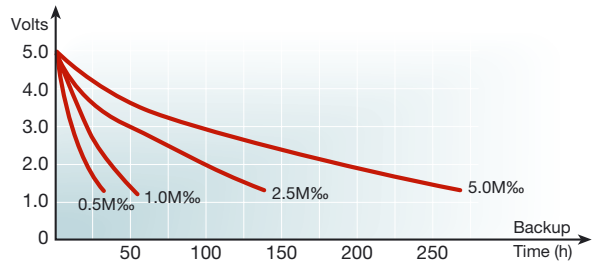

Figure 12. 0.1F – LC, LK, LT, LX, LJ, LM Series

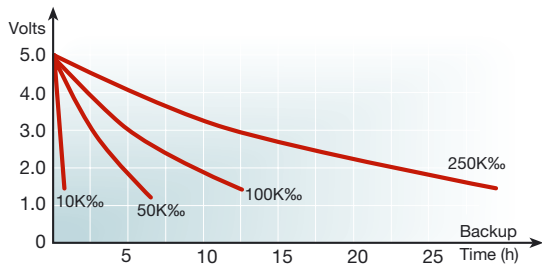

Figure 13. 0.22F – LC, LK, LT, LX, LJ, LM Series

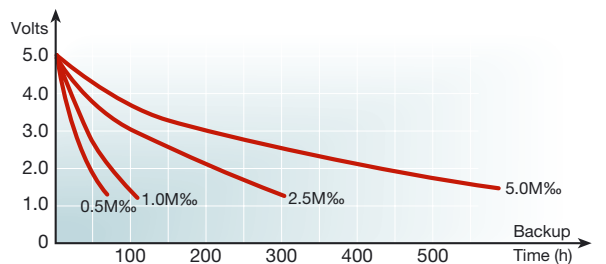

Figure 14. 0.22F – LC, LK, LT, LX, LJ, LM Series

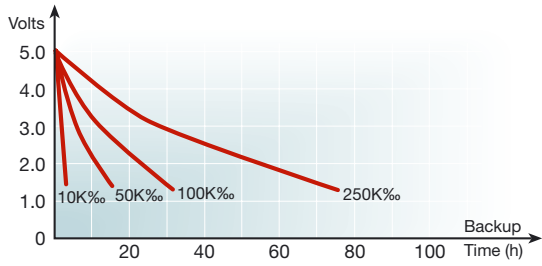

Figure 15. 0.47F – LC, LK, LT, LX, LJ, LM Series

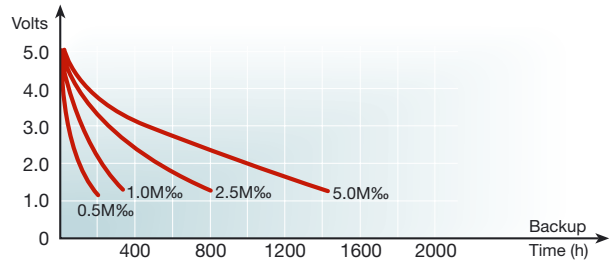

Figure 16. 0.47F – LC, LK, LT, LX, LJ, LM Series

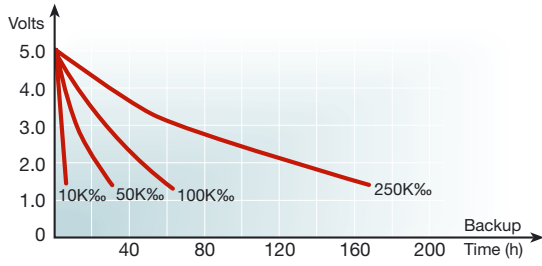

Figure 17. 1.0F – LC, LK, LT, LX, LJ, LM Series

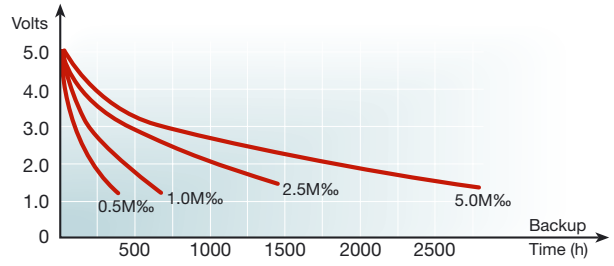

Figure 18. 1.0F – LC, LK, LT, LX, LJ, LM Series

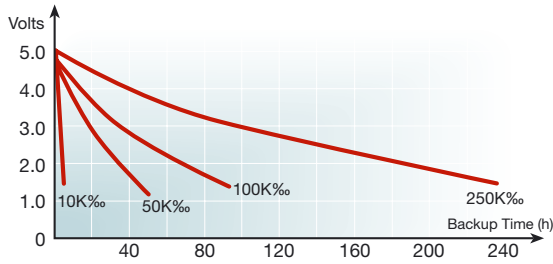

Figure 19. 1.4F – LC Series Only

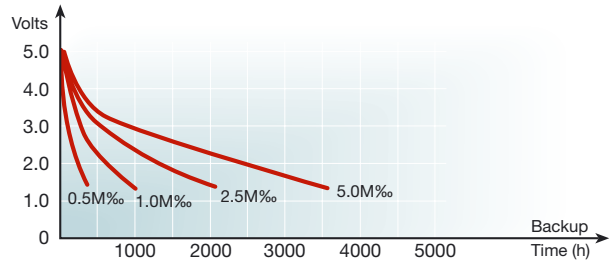

Figure 20. 1.4F – LC Series Only

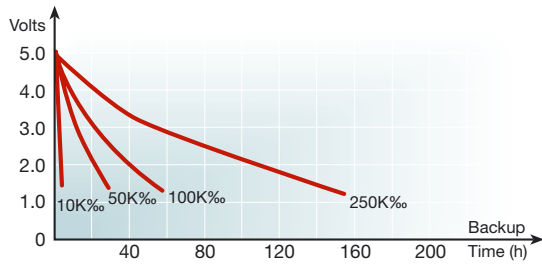

Figure 21. 2.2F – LC, LX, LJ Series

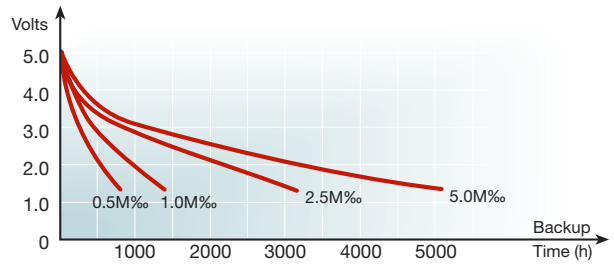

Figure 22. 2.2F – LC, LX, LJ Series

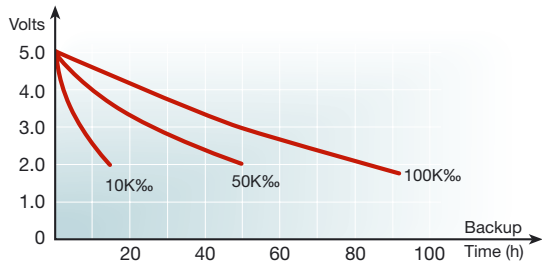

Figure 23. 3.3F - LJ Series

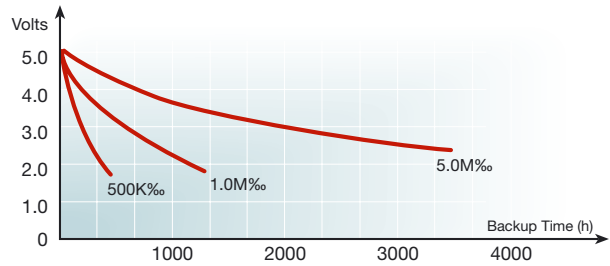

Figure 24. 3.3F - LJ Series

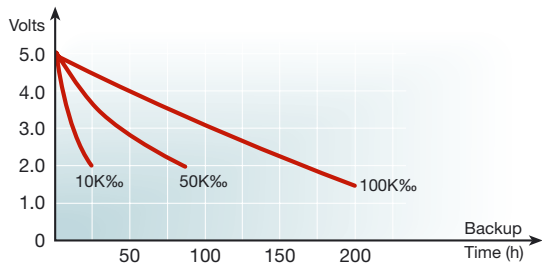

Figure 25. 4.7F - LX & LJ Series

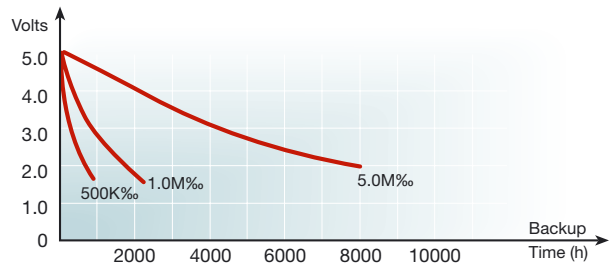

Figure 26. 4.7F - LX & LJ Series

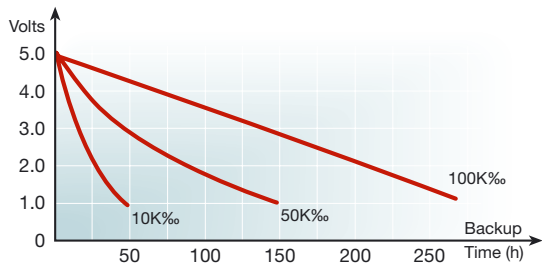

Figure 27. 5.6F - LJ Series

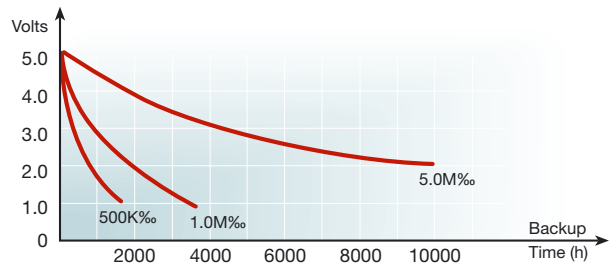

Figure 28. 5.6F - LJ Series

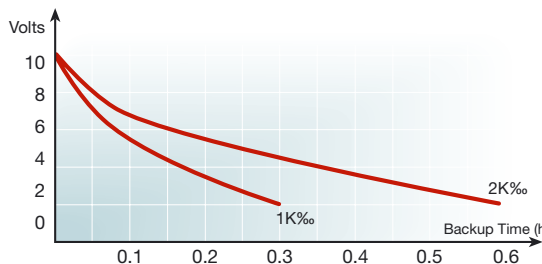

Figure 29. 0.47F - LV Series

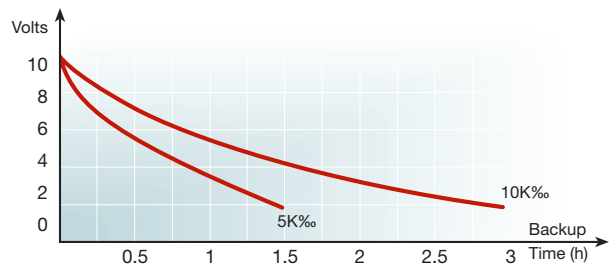

Figure 30. 0.47F - LV Series

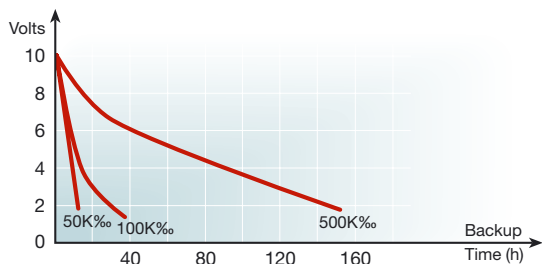

Figure 31. 0.47F - LV Series

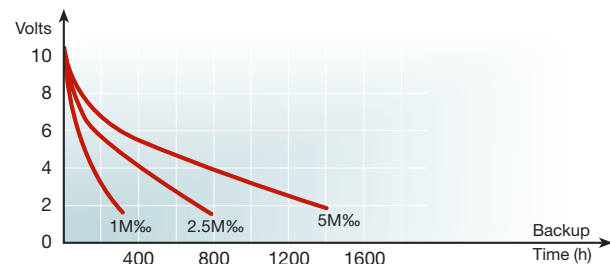

Figure 32. 0.47F - LV Series

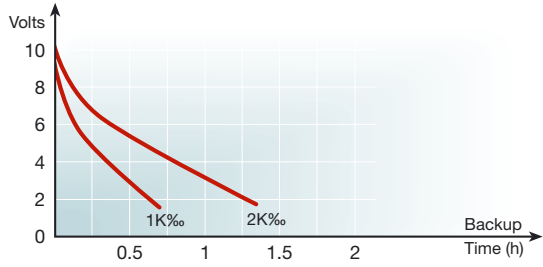

Figure 33. 1.0F-LV Series

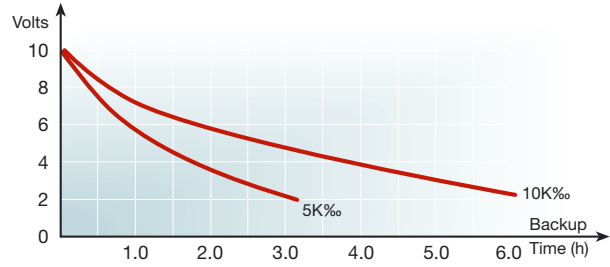

Figure 34. 1.0F-LV Series

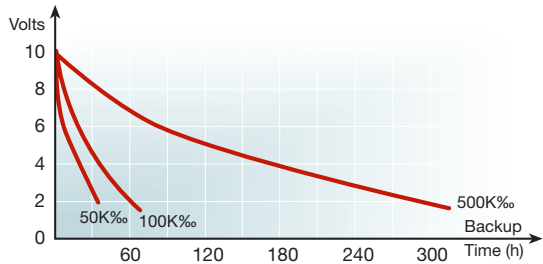

Figure 35. 1.0F-LV Series

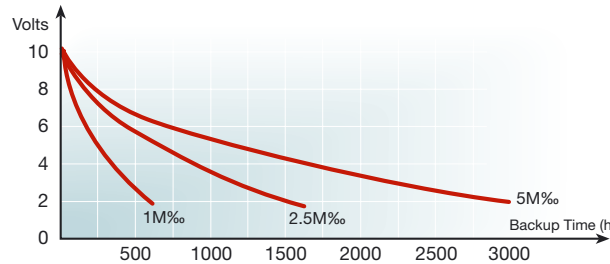

Figure 36. 1.0F-LV Series

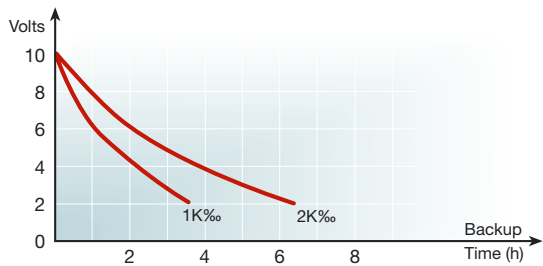

Figure 37. 5.0F-LV Series

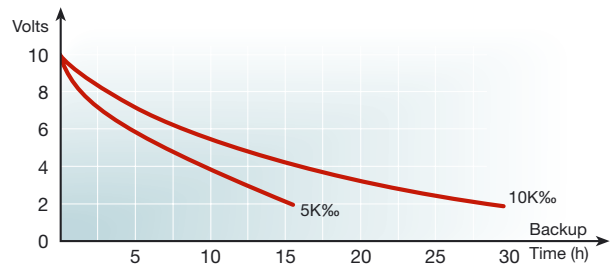

Figure 38. 5.0F-LV Series

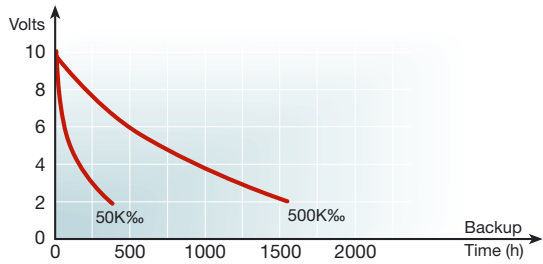

Figure 39. 5.0F-LV Series

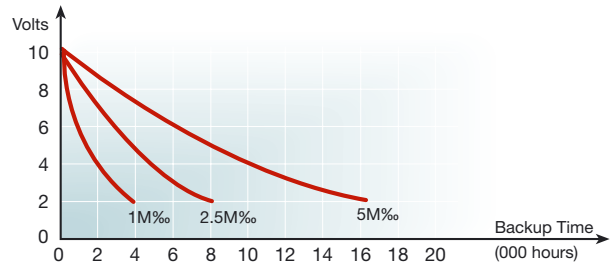

Figure 40. 5.0F-LV Series

Charging Characteristics

Maxcap DLCs can be charged to their working voltage in a matter of seconds. Typical charge time versus voltage and current curves are given in Figure 41.

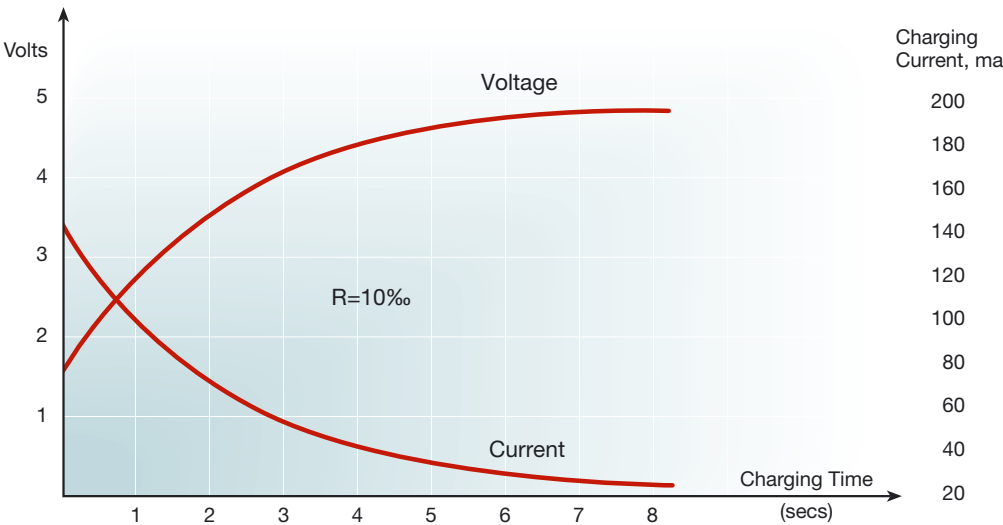
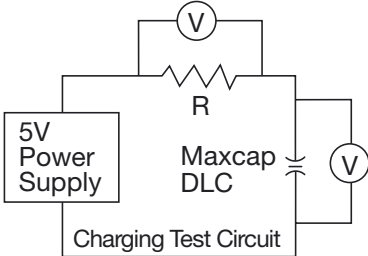

Figure 41. Charging Curves for Maxcap DLC LP055104A

Self Discharge Curves

Figure 42 shows self discharge curves (open circuit) for LC, LK and LT Series capacitors after charging for 24 hours at 5.0 volts.

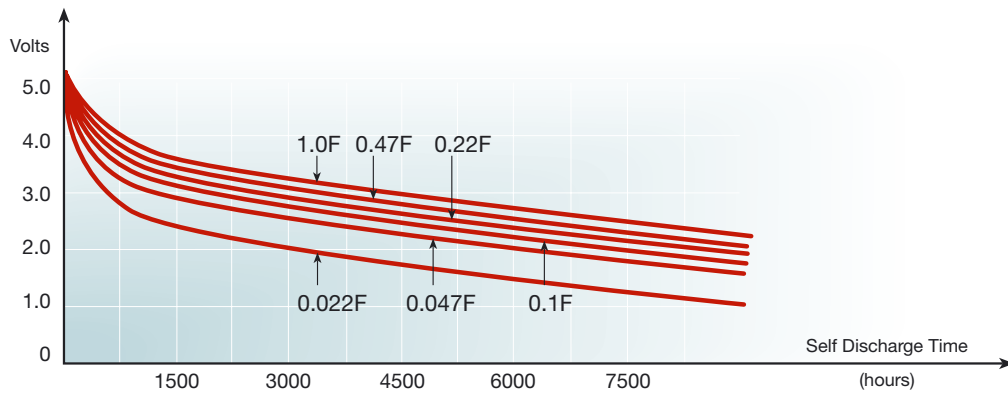

Figure 42 Self discharge curves for LC, LK & LT Series

Long Term Charging Curves

Figure 44 through 52 show typical long term charging curves for each of the Maxcap DLC Capacitor Series using the circuit shown in Figure 43.

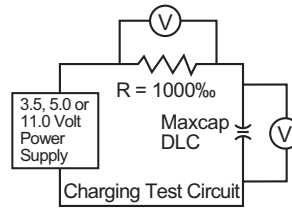

Figure 43.

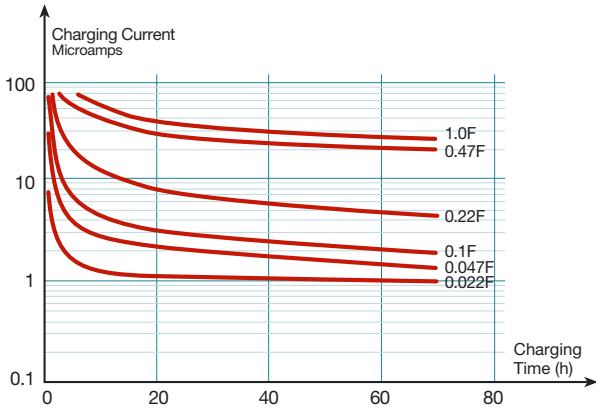

Figure 44. LP Series – 5 Volt Charge

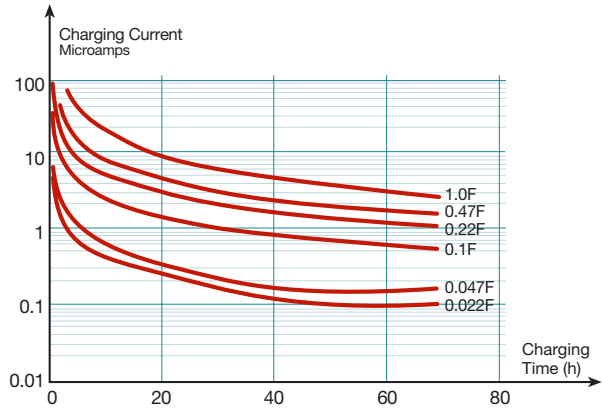

Figure 47. LK Series – 5 Volt Charge

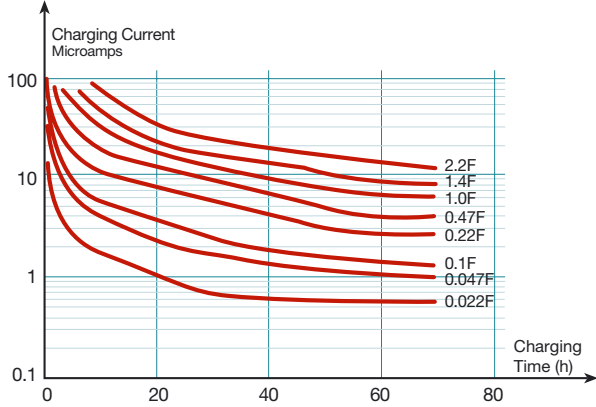

Figure 45. LC Series – 5 Volt Charge

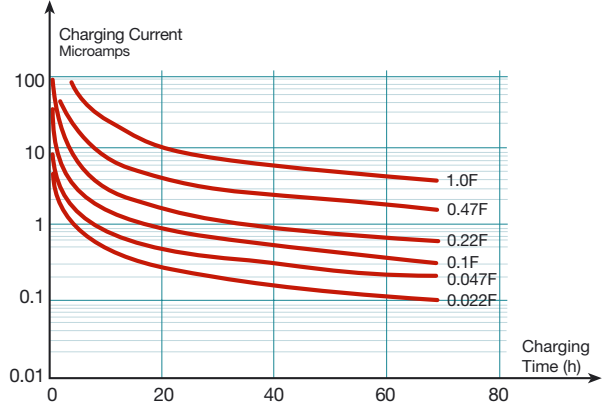

Figure 48. LT Series – 5 Volt Charge

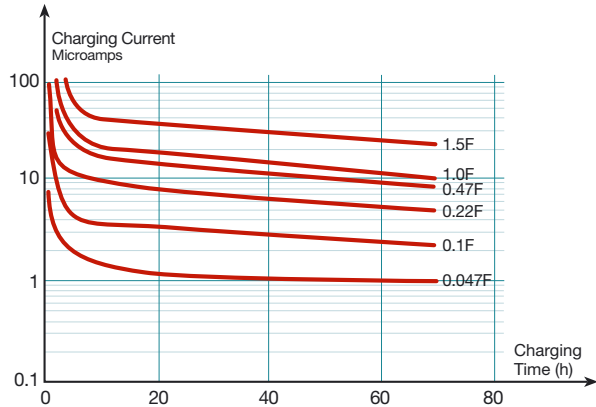

Figure 46. LF Series – 5 Volt Charge

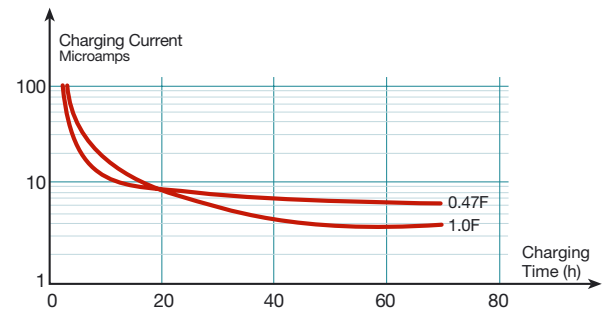

Figure 49. LV Series – 10 Volt Charge

Electrical Characteristics Versus Temperature

Figures 53 and 54 show typical changes in capacitance and ESR over the temperature range from -55 to +85°C. Note that the rated operating temperature

for LP, LV, LC, LK, LX and LF Series capacitors is -25 to +70°C; LT & LJ- Series, -40 to +85°C.

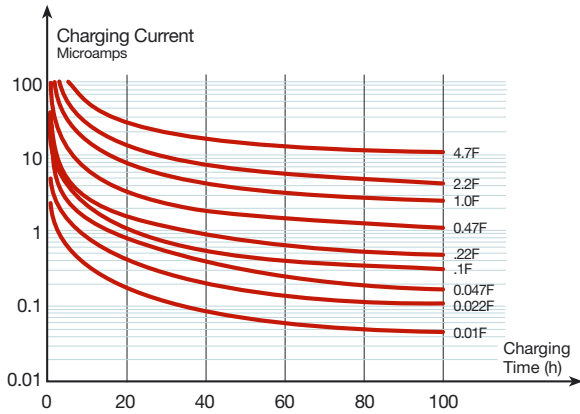

Figure 50. LX Series - 5 Volt Charge

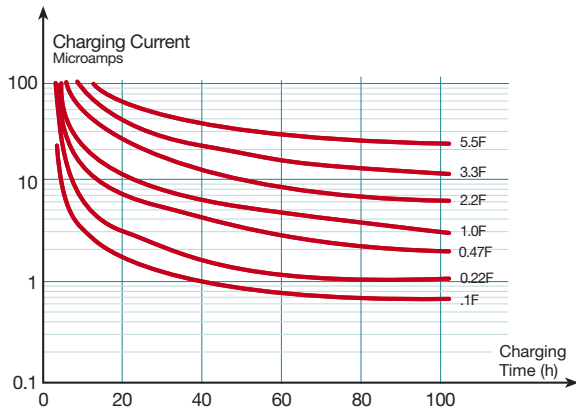

Figure 51. LJ Series - 5 Volt Charge

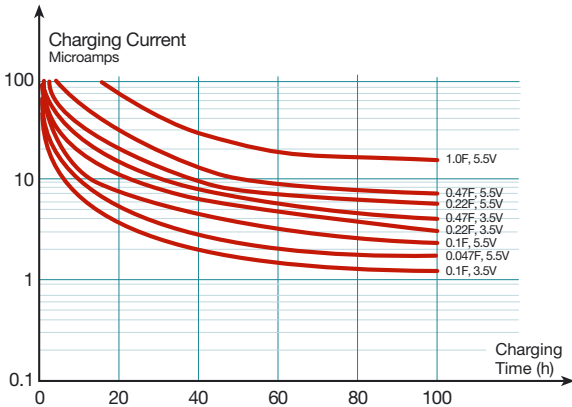

Figure 52. LM Series - 5 and 3.5 Volt Charge

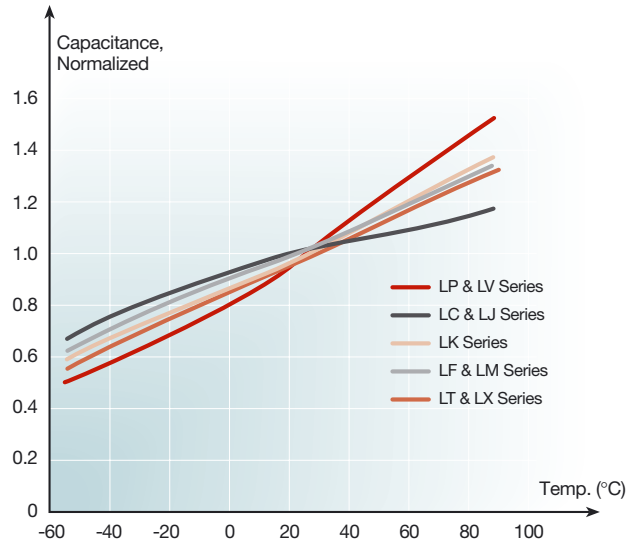

Figure 53. Capacitance Versus Temperature - 1.0F Capacitors

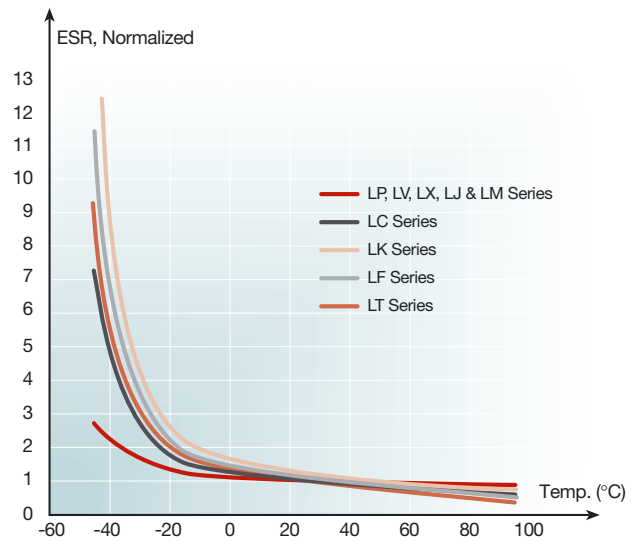

Figure 54. ESR Versus Temperature - 1.0F Capacitors

Application Circuit Information

Maxcap DLCs are ideal for providing backup current for CMOS RAM and clock chip applications. The wide data retention voltage range of CMOS RAMs, typically 5 to 2 volts, is well matched to the voltage decay discharge characteristic of a double layer capacitor.

Maxcap DLCs are also well suited for providing short term primary and backup power for activators, alarms and small motors. Several useful circuits for memory and other backup power applications are discussed below.

Basic Backup Circuit

The Maxcap DLC is usually much simpler to install and requires fewer components for interface than a battery. Figure 55 shows a typical arrangement of components for general backup power applications. The blocking diode prevents wasteful discharge of the double layer capacitor into the power supply. A low reverse leakage Schottky diode can be used here to maximize backup time if the load current drain is in the microamp range.

Alternate Backup Circuit

When it is necessary to maintain voltage at the power supply output level immediately after initializing a system, a charging resistor and additional diode may be required as shown in Figure 56.

Memory Backup Circuit

An interface circuit that is more specific to CMOS device backup is shown in Figure 57. The diode prevents the DLC from discharging into the low resistance of the power supply. Resistor R_s limits the maximum charging current into the capacitor and may not be required, depending on the system supply and the ESR of the capacitor. Resistor R_p is pull up for the chip select (usually an active low input for most static RAMs) that keeps the chip in the deselected or standby state while power is absent.

Voltage Clamping Arrangement

In some cases the designer will not have the flexibility to adjust the output voltage of the power supply to compensate for the voltage drop across the blocking diode. This drop can typically be 0.4 to 0.7 volts, depending on the type of diode used. Figure

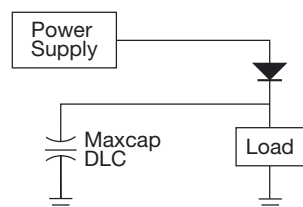

Figure 55. Basic Backup Circuit

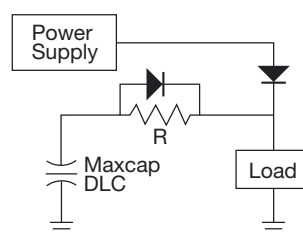

Figure 56. Alternate Backup Circuit

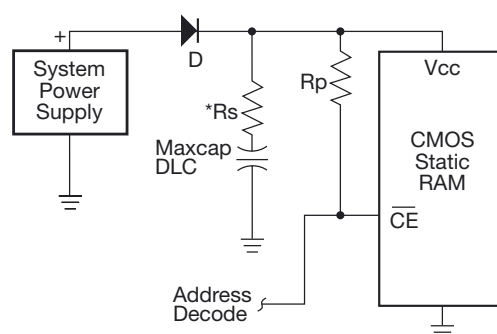

Figure 57. Memory Backup Circuit

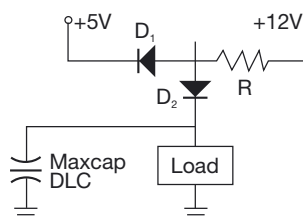

Figure 58. Voltage Clamping Arrangement

58 shows a voltage clamping arrangement that can be used to adjust a 5 volt supply to provide a 5.5 volt charging voltage to compensate for the diode drop. To implement such a circuit a voltage source greater than 5 volts must also be available. In the circuit shown, 12 volts is available.

Application Notes

Service Life

Maxcap DLC service life is dependent on time of use at temperature. At room temperature (20 to 25°C) performance is essentially unchanged over a ten-year period. Useful life decreases as use temperature increases. This is due to gradual water vapor migration from the capacitor through the conductive and insulating rubber package materials that contain and seal the carbon-electrolyte unit cell stack. Moisture loss results in reduced capacitance and increased equivalent series resistance. The basic failure mode of the capacitor is OPEN. This occurs over many decades at room temperature as moisture leaves the package to the atmosphere.

Moisture loss is accelerated with increasing ambient temperature. Our life specification states that the capacitance will be at least 70% of the initial measured value after 1000 hours at maximum rated temperature and voltage. Consult Kanthal Globar with questions about service life that may not be covered in the published specifications.

Polarity

Maxcap Double Layer Capacitors are “burned-in” during the manufacturing process with a standard polarity. The polarity is marked in two ways: 1) the double black line down the side of capacitor indicates the negative terminal, and 2) the longer lead, which is connected to the case, is the negative terminal.

Due to the burn-in process, the capacitor may actually have some residual potential (charge) when it arrives at the customer location. Care should be taken when handling the capacitor as residual charge may have an adverse effect on adjacent components.

Maxcap DLCs cannot be damaged if charged in a reverse polarity direction at rated voltage. If installed by accident with the polarity reversed, after a period of time at maximum rated voltage, the capacitor will actually take a “set” to the new polarity. After 3 to 7 days at the new polarity, the capacitor characteristics (capacitance, ESR and leakage current) will be the same as though the capacitor were installed correctly.

In conclusion, it is best if the capacitor is installed in accordance with the indicated polarity, but in the long term there will not be any adverse effects on the capacitor if it is installed in the reverse direction. Although the Maxcap DLC will not suffer long term from reverse polarity installation, the possible effects of reverse polarity installation on equipment should be considered.

Cleaning Solutions

Standard Maxcap DLC products should not be completely immersed in PC Board cleaning or washing solutions as these solutions can enter the capacitor container at the crimp line or near the lead egress area. Heavy spray of cleaning solutions can also lead to contamination, especially if liquid is trapped between the board and capacitor and liquid is “wicked” up into the can. A light spray of water or non-aggressive cleaning solution is usually not a problem. Ultrasonic cleaning should be avoided.

An epoxy end-seal option is available as a special product to prevent washing solutions from entering the capacitor package. Refer to the “Ordering Information” section on page 5 to see how to specify this option.

Use Beyond Rated Voltages

Some systems may require backup power voltages in excess of the 5.5 and 11.0 volt maximum voltage rating of standard Maxcap double layer capacitors. Maxcap DLCs can be used in these applications by connecting devices in series to obtain the desired system backup voltage. Using the following guidelines will assure maximum performance and unlimited cycle life from Maxcap capacitors.

The main precaution to observe when using series-connected Maxcap DLCs is to make certain that the voltage across any individual device in the series string does not exceed the maximum voltage rating for extended periods of time. This can be accomplished by making sure the operating applied voltage does not exceed the sum of the individual Maxcap DLC maximum voltage ratings. Optimum operation can be achieved if the system applied voltage is distributed equally among all devices during charging and discharging of the capacitors.

The first step toward achieving a balanced condition is to use devices that are all of the same series and rated capacitance. In applications where only two devices are used and the duty cycle is relatively short, this alone may provide adequate balancing. However, in strings of more than two or under long on-charge times, there is increased risk of exceeding the capacitor rated voltage if no other measurements are taken. During very long charge times, small variations in the device capacitance and leakage current will be magnified and may result in relatively large imbalances. By examining the factors that cause unequal voltage distribution, the design engineer can implement effective means to minimize these effects.

The distribution of voltage across individual elements of a series string of DLCs is determined by the electrical characteristics of each device. The relevant properties are capacitance, leakage current and, to some extent, equivalent series resistance. The following example illustrates how these characteristics affect the charging of series-connected Maxcap DLCs. The following example shows what happens when the series connected Maxcap DLCs in Figure 59 are charged.

At the instant voltage is applied the voltage across C_1 is 4.5 volts, and across C_2 is 5.5 volts in proportion to their ESR. This condition lasts only briefly. Since

the capacitors are in series, each accumulates charge at the same rate. From the definition of capacitance, $C = Q/V$, the voltage across C_1 will increase faster by virtue of its lower capacitance at equal charge. At some point in the charge process, as the ultimate value of leakage current is approached, the higher steady-state leakage current of C_1 will cause its voltage to level off first. C_2 's voltage will continue to increase, however, because of its lower leakage current. Eventually, C_1 and C_2 will reach the same steady-state leakage current. As shown in Figure 60, C_2 's voltage will exceed that of C_1 at the same steady-state leakage current. The value of leakage

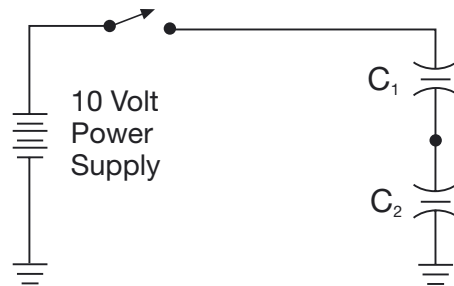

Figure 59. Series Connected Maxcap DLCs.

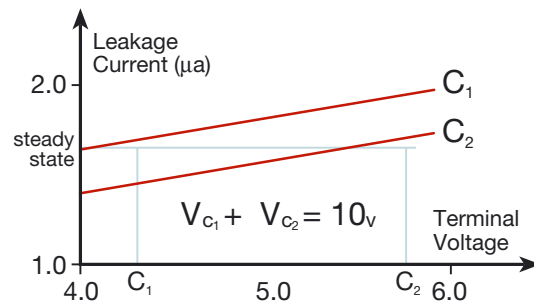

Figure 60. Series Connected Maxcap DLC Leakage Current Versus Voltage.

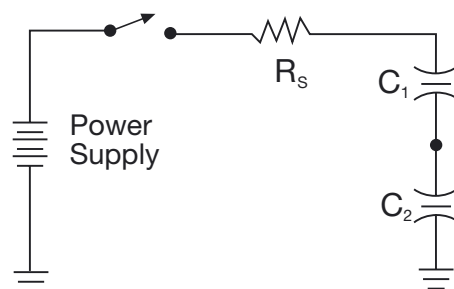

Figure 61. Series Resistor to Limit Charge Current.

current will be that current at which the sum of the capacitor voltages equals the applied ten volts.

This example illustrates that significant voltage differences can occur during the charging process. Several easy methods can be used to assure equalized charging.

To correct the situation occurring at the instant charging begins, a small resistance can be added in series with the capacitors to limit the initial value of inrush current, as shown in Figure 61. In many cases this resistor may be desirable anyway to limit the power supply current. The value of this resistor can be quite high, its upper limit being determined by the charging time required.

Of greater concern is the imbalance resulting from the difference in leakage current and capacitance as these effects are of longer duration and tend to build up over time. One corrective method is to simply add shunt resistors of equal value across each device to provide a voltage divider that forces equalization of voltage throughout the string. This reliable and inexpensive approach is shown in Figure 62. Figure 59 shows the series connection of two model LP055473A (0.047F) 5.5 volt capacitors having the following individual device properties:

Device	ESR (ohms)	Capacitance (F)	Leakage Current at 5 Volts (μ A)
C1	7.0	0.052	1.8
C2	8.6	0.068	1.4

The only drawback to this solution is that the voltage divider resistors consume energy during the discharge portion of the cycle and thus can shorten the backup time available. As a practical matter, the resistors' value can usually be chosen such that their current draw is low relative to the load current. The resistors will then have no discernable effect on backup time.

The maximum value for these resistors is constrained by the leakage current range of the particular DLC. It has been found that setting the divider current to a value about equal to the device leakage current is the practical limit that will maintain the balancing action. In the example described in Figure 59, a practical upper limit for balancing resistors on R_1 and R_2 would be about 2.5 megohms. The table below shows maximum recommended resistor size ($R_{max.}$) for a range of LP series Maxcap DLCs.

	Capacitance (F)	R_{max} Model (Megohms)
LP055223A	0.022	5
LP055473A	0.047	2.5
LP055104A	0.1	2.0
LP055224A	0.22	1.0
LP055474A	0.47	0.3
LP055105A	1.0	0.2

As an example of the impact on Figure 59 backup time, the approximate backup time for a resistive load of two micro-amps decreases to about 50 percent of the time available without the resistors, with the probable lifetime greatly extended. If longer backup time is required, this situation can be achieved by using the next larger size Maxcap DLC.

A lower value divider resistor will provide faster equalization, at the expense of recovery time and total dissipation. The lower limit should be determined by power dissipation and backup time limitations, and by charging time requirement.

Another method of providing overvoltage protection to the series of capacitors is to shunt each device with a zener diode of five to six volts, as in Figure 63. As the rising capacitor voltage exceeds the zener

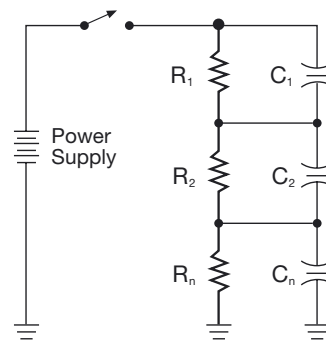

Figure 62. Voltage Divider Using Shunt Resistors for Charge Balancing.

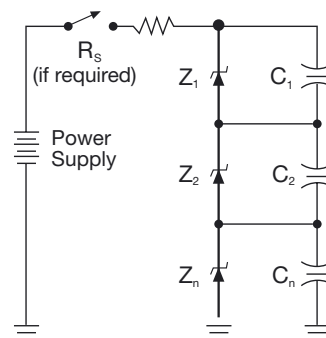

Figure 63. Voltage Divider Using Shunt Zener Diodes for Overvoltage Protection.

breakdown voltage, the diode begins to conduct and shunt charging current around the individual capacitor that is charging fastest. Additional charging current is thus directed to the capacitors that remain at a lower voltage, allowing them time to charge faster.

Unlike the method employing shunting resistors, this method has the advantage of not resulting in reduced backup time. The zener shunt method can be employed in cases where the resistor method would incur an intolerable backup time penalty but space limitations preclude an increase in Maxcap DLC size.

A precaution that should be observed is to make sure that the sum of the zener breakdown voltages in the string exceeds the total applied voltage. If it does not, a series resistor should be used to limit the zener current.

By using these sample techniques, Maxcap double layer capacitors can provide the benefits of high energy density and unlimited cycle life to applications for backup voltages beyond five volts.

Operating Principal

The Maxcap DLC capitalizes on the electric double layer principle first described by Helmholtz.* This model shows an array of charged particles and oriented dipoles that form at the interface of any two phases (solid/solid, solid/liquid, etc.) The interface exhibits a capacitive effect such that the application of an electric field results in an accumulation of electrostatic charges in a double layer.

The Maxcap DLC uses an electrode consisting of activated carbon into which an ionically conductive liquid electrolyte is absorbed. As shown in Figure 64, the electric double layer is created at the interface of the carbon and electrolyte.

In a classical plate capacitor, the capacitance (amount of charge that can be stored) is a function of plate area. The Maxcap DLC plate area corresponds to the area of the capacitive electric double layer. The extremely high surface area of the activated carbon electrode material, up to 1000 m²/gram, makes the area of the double layer very large. This causes Maxcap DLCs to reach a commensurately high volumetric efficiency.

**H.L. von Helmholtz, Wied. Ann., 7,33 (1879)*

Double Layer – Formed with Two Phases in Contact Capacitance – Arises when Potential is Applied

Electric Double Layer

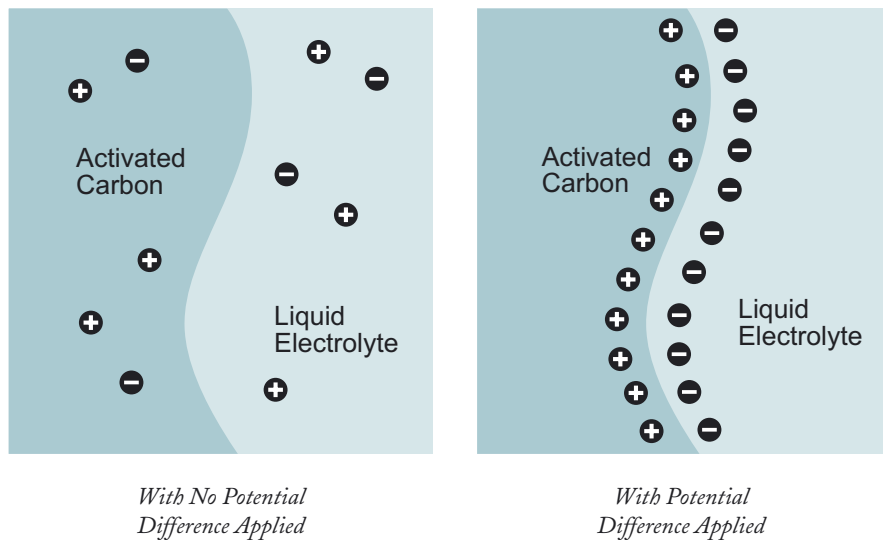

Figure 64. Electric Double Layer Principle

Construction

The construction of Maxcap double layer capacitor is shown in Figure 65. Two identical electrolyte-moistened carbon electrodes face each other across an ionically conductive, porous separator. Electroconductive rubber endcaps provide the seal and electrical contact. The entire arrangement comprises one unit cell. Figure 67 illustrates the action of charges stored within a single unit cell.

The aqueous electrolyte used in the Maxcap DLC begins to break down at about 1.2 volts, the breakdown potential of water; therefore, capacitors with useful voltage ratings are constructed of a series-connected stack of unit cells inserted into a metal can. Six unit cells are stacked to build a Maxcap DLC rated at 5.5 volts. Twelve unit cells are stacked for a DLC rated in 11.0 volts. When

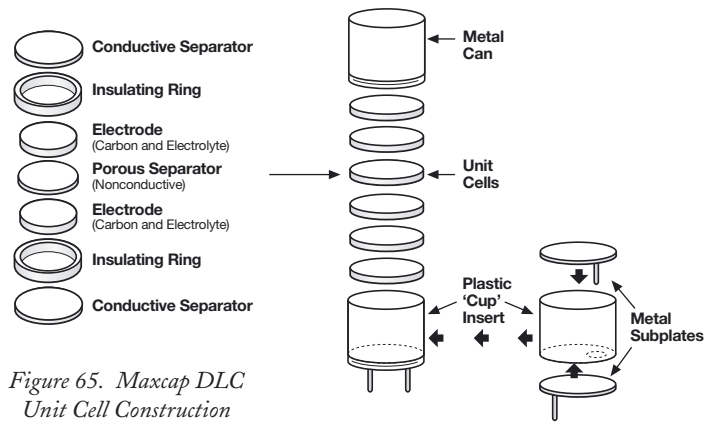

Figure 65. Maxcap DLC Unit Cell Construction

Figure 66. Maxcap Double Layer Capacitor Assembly

charged to the rated voltage, each cell has a potential close to 0.9 volts. The difference between the breakdown and working voltages is a safety margin. The arrangement of a six-cell capacitor is shown in Figure 66.

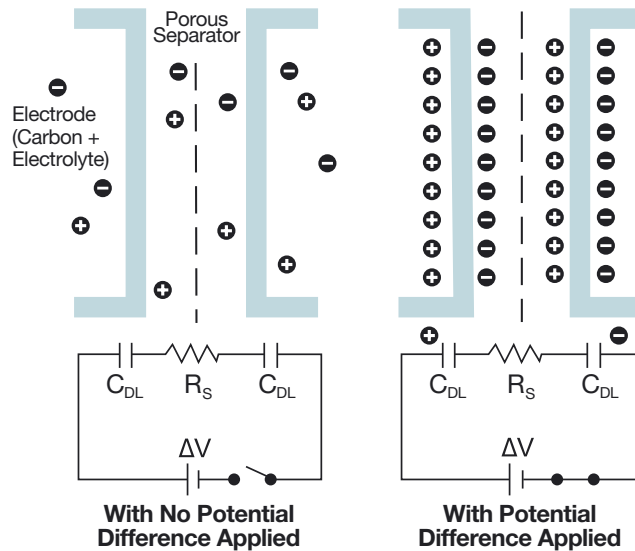

Figure 67. Maxcap DLC Unit Cell Operation





Sandvik Materials Technology

KANTHAL GLOBAR 495 COMMERCE DRIVE STE 7 AMHERST, NY 14228-2311
Tel: 716-691-4010 Fax: 716-691-7850 sales.globar@kanthal.com www.globar.com www.kanthal.com

11-B-1-3 09/07 www.idebild.com