

Rocker Switch



Single Pole

TR Series

Features

- Lighted & non-lighted versions available
- Maintained and momentary action
- 16 A switching in 1 mm wide packaging
- RoHS compliant
- Minimum 10,000 operations mechanical life

Standard Parts¹

North America and Europe			Europe Only	
TRG22F2BBRLN	TRG22F2FBBNN	TRG22F2BBGEN	TRG22F2BBGLN	TRG22F2BBREN

¹The part number configuration matrix below provides details to the part numbers above. For configurable part numbers that are not listed above, contact the factory or your distributor.

Part Number Breakdown

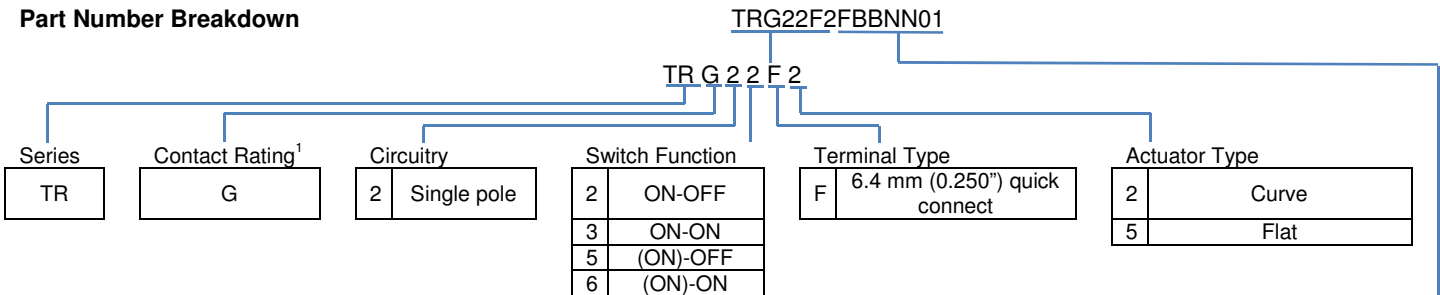

¹See Electrical Specifications section

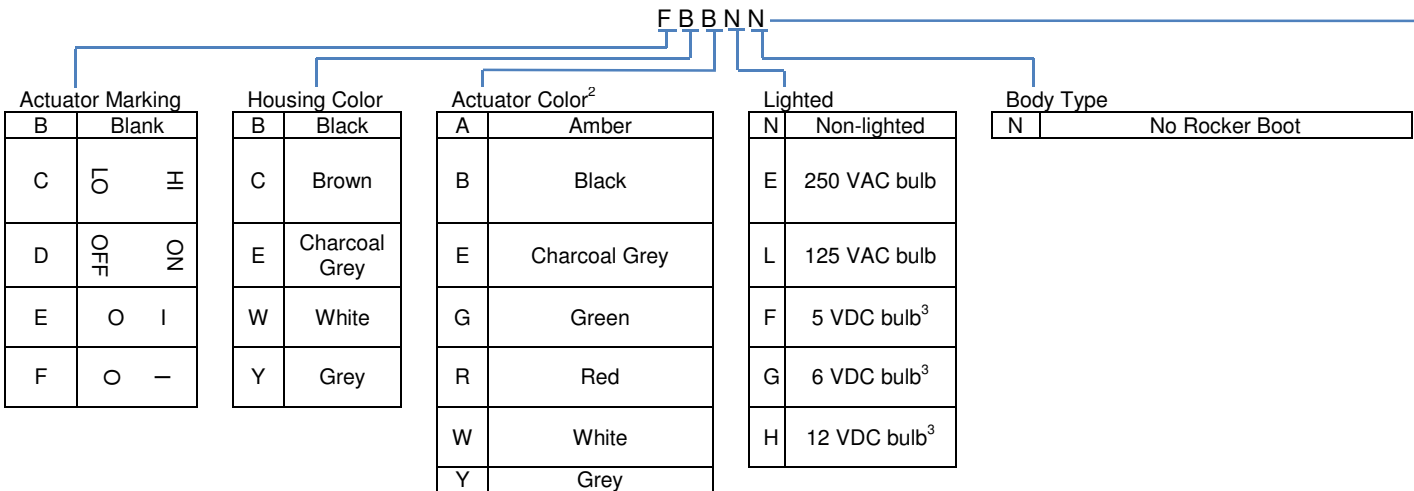

²Charcoal Grey, White, Grey not available for illuminated actuator

³Switches have no agency DC ratings



Electrical Specifications

Inrush Rating – 2 Position				48 A
Inrush Rating – 3 Position				24 A
Dielectric Strength				1000 VAC for 1 minute
Insulation Resistance				100 MΩ min at 500 VDC
Initial Contact Resistance				0.020 Ω max
Switch Function	EN61058-1 Rating	UL General Purpose Rating	UL HP Rating	
All	16 (4) A 250 VAC ~T85/55	16 A 125 VAC / 16 A 250 VAC	¼ HP 125 VAC / ¾ HP 250 VAC	
Electrical Life at Rated Load Minimum Operations	VDE	UL		
	10,000	6,000		
UL File No: E23301				

Material and Environmental Specifications

Actuator, non-lighted				Nylon 66 94V-2
Actuator, lighted				Polycarbonate
Base				Nylon 66 94V-2
Spring				Steel Wire
Contacts				Silver Alloy
Movable Arm				Silver-Plated Copper Alloy
Terminals				Silver-Plated Copper Alloy
Operating Temperature Range				-20 °C to +85 °C (-4 °F to +185 °F)

Circuitry and Switch Functions

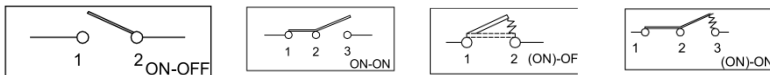

Dimensions mm (inches)

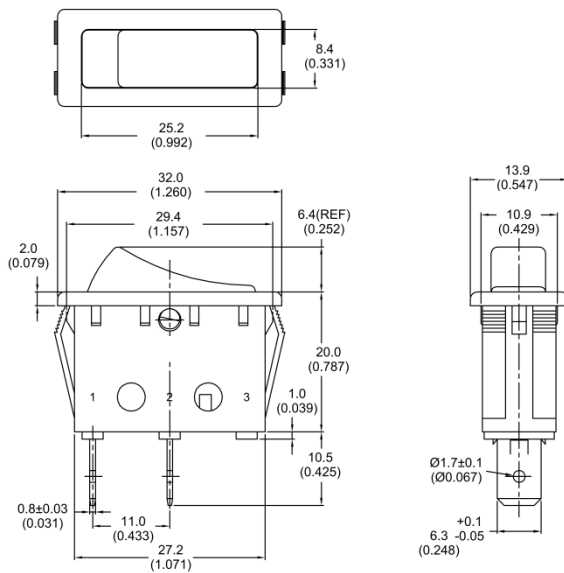

NOTE: TOLERANCES UNLESS OTHERWISE SPECIFIED: ± 0.3 (0.012)

Recommended Panel Cut-Out Dimensions		
Panel thickness	X Dimension	Y Dimension
0.75 to 1.25 (0.030 to 0.049)	30.23 (1.19)	11.00 (0.433)
1.25 to 2.00 (0.049 to 0.079)	30.48 (1.20)	11.00 (0.433)
2.00 to 3.00 (0.079 to 0.118)	30.73 (1.21)	11.00 (0.433)

