

Interface relays and optocouplers

Product group picture

5

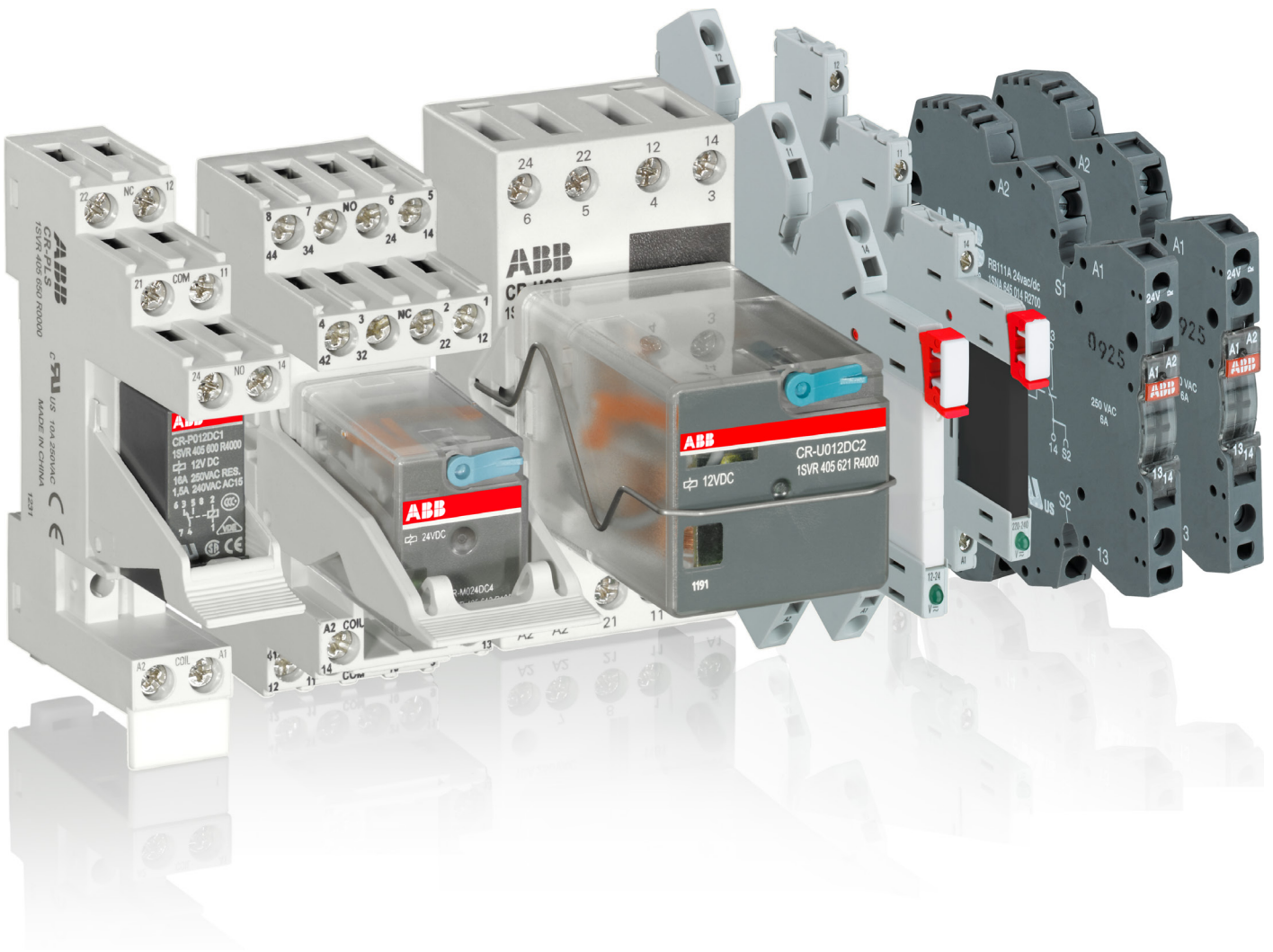

Interface relays and optocouplers

Table of contents

Interface Relays and Optocouplers

Benefits and advantages	5/3
Pluggable interface relays and optocouplers	5/6
Table of contents	5/6
Socket types	5/7
Ordering details - CR-S range	5/8
Relay assemblies	5/9
Optocoupler assemblies	5/9
Ordering details - CR-P range	5/10
Ordering details - CR-M range	5/11
Ordering details - CR-P/M function modules	5/14
Ordering details - CR-U range	5/15
Ordering details - CR-U function modules	5/16
Technical data - CR-P, CR-M, CR-U	5/17
Technical data, load limit curves - CR-P, CR-M, CR-U	5/19
Technical data - CR-P optocouplers	5/20
Technical data - Sockets for CR-P and CR-M	5/21
Technical data - Sockets for CR-U	5/22
Load limit curves - CR-P, CR-M and CR-U	5/23
Technical data - CR-S interface relays	5/24
Technical data - CR-S optocouplers	5/25
Technical data - CR-S sockets	5/26
Connection diagrams	5/27
Dimensional drawings	5/28
Boxed interface relays and optocouplers R600 range	5/32
Table of contents	5/32
Overview	5/33
Benefits and advantages	5/34
Boxed interface relays R600 range	5/35
Selection	5/35
Ordering details	5/37
Connection diagrams	5/39
Technical data	5/40
Load limit curves, Dimensional drawings	5/43
Boxed optocouplers R600 range	5/45
Selection	5/45
Ordering details	5/46
Connection diagrams	5/47
Technical data	5/48
Technical data, Dimensional drawings	5/50

Interface relays and optocouplers

Benefits and advantages

Slim relays and optocouplers CR-S

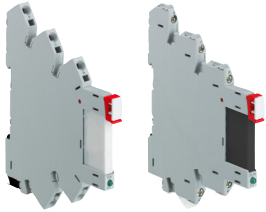

- Standard slim relays (5 mm), optocouplers (5 mm), sockets (6.2 mm) and accessories
- Combination of 9 different rated control supply voltages possible:
 - DC versions: 5 V, 12 V, 24 V
 - AC/DC versions: 12 V, 24 V, 48 V, 60 V, 110 V, 230 V
- Output relay: 1 c/o (SPDT) contact (6 A), standard and gold-plated
- Output optocoupler: Transistor 100 mA - 48 V DC, MOS-FET 2 A - 24 V DC, Triac 2 A - 240 V AC
- Cadmium-free contact material
- All sockets with LED
- Screw and spring connection terminals
- Jumper bar (red, black, blue), marker and separator available as accessories

Pluggable PCB relays and optocouplers CR-P



- 9 different coil voltages
 - DC versions: 12 V, 24 V, 48 V, 110 V
 - AC versions: 24 V, 48 V, 110 V, 120 V, 230 V
- Output contacts:
 - Output relay: 1 c/o contact (16 A)
 - 2 c/o contact (8 A), standard and gold-plated
 - Output optocoupler: MOS-FET 5 A - 35 V DC, Triac 3 A - 275 V AC
- Logical or standard sockets
- Cadmium-free contact material
- Width of socket: 15.8 mm
- Pluggable function modules
 - Reverse polarity protection/Free wheeling diode
 - LED indication
 - RC elements
 - Overvoltage protection

Pluggable miniature relays CR-M



- 12 different coil voltages
 - DC versions: 12 V, 24 V, 48 V, 60 V, 110 V, 125 V, 220 V
 - AC versions: 24 V, 48 V, 110 V, 120 V, 230 V
- Output contacts
 - 2 c/o contacts (12 A) or
 - 3 c/o contacts (10 A) or
 - 4 c/o contacts (6 A)
 - optionally equipped with gold contacts, LED and free wheeling diode
- Integrated test button for manual actuation and locking of the output contacts (blue = DC, orange = AC) that can be removed if necessary
- With or without integrated LED
- Logical or standard sockets
- Cadmium-free contact material
- Width on socket: 27 mm
- Pluggable function modules
 - Reverse polarity protection/Free wheeling diode
 - LED indication
 - RC elements
 - Overvoltage protection

Pluggable universal relays CR-U



- 12 different coil voltages
 - DC versions: 12 V, 24 V, 48 V, 110 V, 125 V, 220 V
 - AC versions: 24 V, 48 V, 60 V, 110 V, 120 V, 230 V
- Output contacts
 - 2 c/o contacts (10 A) or
 - 3 c/o contacts (10 A)
- Integrated test button for manual actuation and locking of the output contacts (blue = DC, orange = AC) that can be removed if necessary
- With or without integrated LED
- Cadmium-free contact material
- Width on socket: 38 mm
- Pluggable function modules
 - Reverse polarity protection/Free wheeling diode
 - LED indication
 - RC elements
 - Overvoltage protection
 - Multifunction time module

Interface relays and optocouplers

Benefits and advantages

R600 series interface relays and optocouplers



- Boxed slim relays and optocouplers modules 6 mm or 12 mm
- 8 different rated control supply voltages:
 - DC versions: 5 V, 12 V, 24 V
 - AC/DC versions: 24 V, 48-60 V, 115 V, 230 V, 60-230 V
- Output relay: 1 n/c contact, 1 n/o contact, 1 c/o (SPDT) contact, 2 c/o (SPDT) contacts
- Output optocoupler: Transistor 100 mA - 58 V DC. MOS-FET 2 A / 5 A - 58 V DC, Triac 1 A / 2 A - 230 V AC
- Devices with output contacts protected by built in RC circuit, which result in increased contact life
- Devices with leakage current protection on the input side
- All products with LED for the indication of the operational state
- Screw or spring-type terminals
- Jumper bars and separator end section as accessories

Pluggable interface relays and optocouplers

Product group picture

5

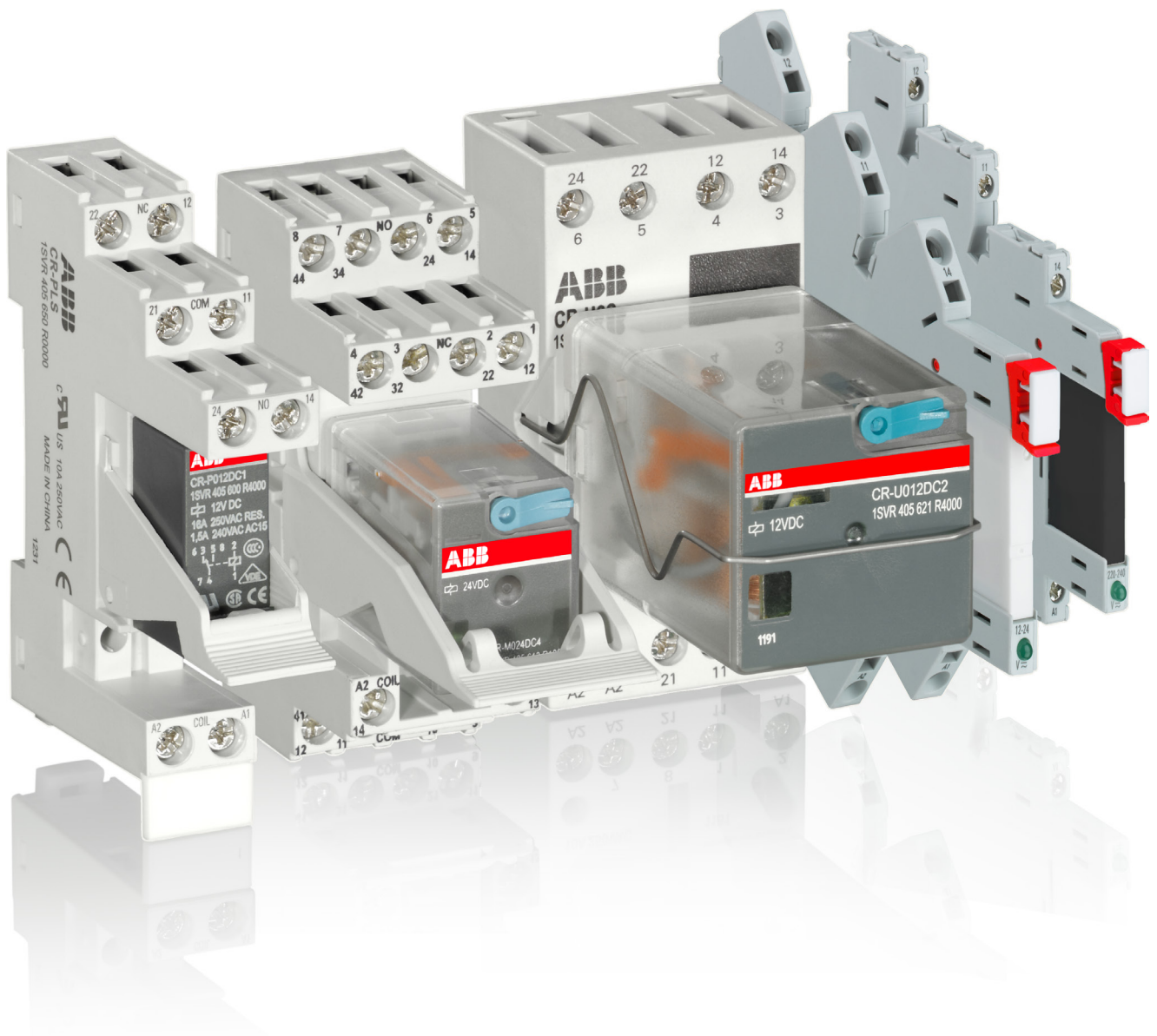

Pluggable interface relays and optocouplers

Table of contents

Pluggable interface relays and optocouplers

Socket types	5/7
Ordering details - CR-S range	5/8
Ordering details - Relay assemblies, Optocoupler assemblies	5/9
Ordering details - CR-P range	5/10
Ordering details - CR-M range	5/11
Ordering details - CR-P/M function modules	5/14
Ordering details - CR-U range	5/15
Ordering details - CR-U function modules	5/16
Technical data - CR-P, CR-M, CR-U	5/17
Technical data, load limit curves - CR-P, CR-M, CR-U	5/19
Technical data - CR-P optocoupler	5/20
Technical data - Sockets for CR-P and CR-M	5/21
Technical data - Sockets for CR-U	5/22
Load limit curves - CR-P, CR-M and CR-U	5/23
Technical data - CR-S interface relays	5/24
Technical data - CR-S optocoupler	5/25
Technical diagrams - CR-S interface relays, CR-S optocouplers	5/25
Technical data - CR-S range sockets	5/26
Connection diagrams	5/27
Dimensional drawings	5/28

Pluggable interface relays and optocouplers

Socket types

Kind of connecting terminals

Kinds of sockets

Standard sockets - Position of connecting terminals:
Coil connection (A1-A2) on lower socket side, contact connections (n/o and n/c contacts) on the lower and upper socket side.

Logical sockets - Position of connecting terminals:
Coil connection (A1-A2) on lower socket side, all contact connections (common contacts, n/o and n/c contacts) on upper socket side.

Details see connection diagrams

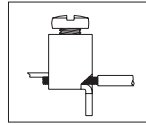

Screw type

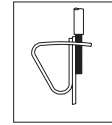

Spring type

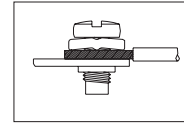

Fork type

CR-S Range

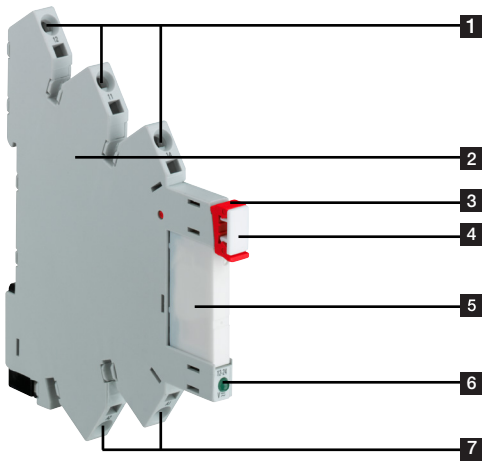

- 1 Output contacts
- 2 Socket
- 3 Relay holder
- 4 Marker
- 5 Interface relay
- 6 LED green: Control supply voltage applied
- 7 Control supply voltage

CR-P range

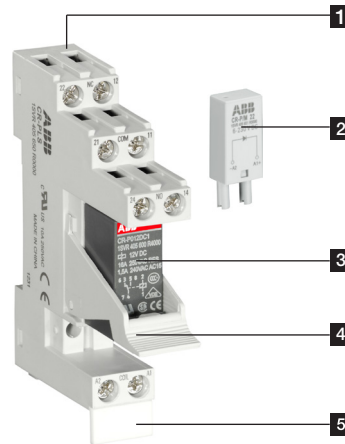

- 1 Socket
- 2 Pluggable function module
- 3 Interface relay
- 4 Holder
- 5 Marker label

CR-M range

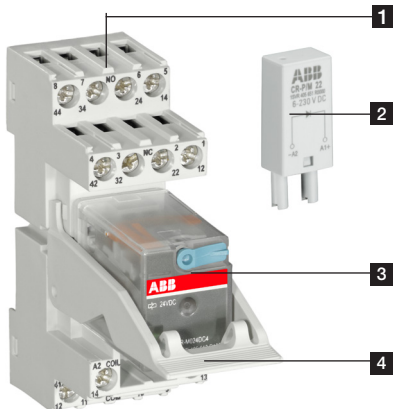

- 1 Socket
- 2 Pluggable function module
- 3 Interface relay
- 4 Holder

CR-U range

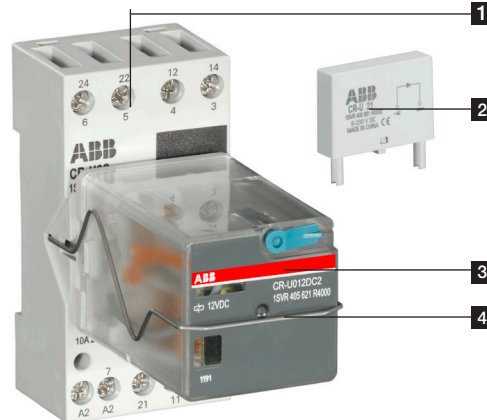

- 1 Socket
- 2 Pluggable function module
- 3 Interface relay
- 4 Holder

Pluggable interface relays and optocouplers

Ordering details - CR-S range



CR-S Interface relay

2CDC 281 006 S0014



CR-S Optocoupler

2CDC 281 003 S0016

Ordering details - CR-S range pluggable interface relays

Rated control supply voltage	Outputs	Contact ratings	Type	Order code	Price	Pkg qty	Weight (1 pc) kg (lb)
5 V DC	1 c/o (SPDT) standard contacts	250 V, 6 A	CR-S005VDC1R	1SVR405501R1010		10	0.005 (0.011)
12 V DC			CR-S012VDC1R	1SVR405501R2010			
24 V DC			CR-S024VDC1R	1SVR405501R3010			
48 V DC			CR-S048VDC1R	1SVR405501R4010			
60 V DC			CR-S060VDC1R	1SVR405501R5010			
5 V DC	1 c/o (SPDT) gold plated contacts	12 V, 250 mA (3W) ¹⁾	CR-S005VDC1RG	1SVR405501R1020		10	0.005 (0.011)
12 V DC			CR-S012VDC1RG	1SVR405501R2020			
24 V DC			CR-S024VDC1RG	1SVR405501R3020			
48 V DC			CR-S048VDC1RG	1SVR405501R4020			
60 V DC			CR-S060VDC1RG	1SVR405501R5020			

Ordering details - CR-S range pluggable optocoupler

Rated control supply voltage	Outputs	Type	Order code	Price	Pkg qty	Weight (1 pc) kg (lb)
24 V DC	Transistor, 100 mA - 48 V DC	CR-S024VDC1TRA	1SVR405510R3050		10	0.004 (0.009)
	MOS-FET, 2 A - 24 V DC	CR-S024VDC1MOS	1SVR405510R3060			
	Triac, 2 A - 240 V AC	CR-S024VDC1TRI	1SVR405510R3070			

5

Ordering details - CR-S range complete interface relays (relay + socket)

Rated control supply voltage	Outputs	Contact ratings	Type	Order code	Price	Pkg qty	Weight (1 pc) kg (lb)
24 V AC/DC	1 c/o (SPDT) standard contacts	250 V, 6 A	CR-S024VADC1CRS	1SVR405541R3110		10	0.03 (0.066)
110 V AC/DC			CR-S024VADC1CRZ	1SVR405541R3210			
			CR-S110VADC1CRS	1SVR405541R6110			
230 V AC/DC			CR-S110VADC1CRZ	1SVR405541R6210			
24 V AC/DC	1 c/o (SPDT) gold plated contacts	12 V, 250 mA (3W) ¹⁾	CR-S024VADC1CRGS	1SVR405541R3120		10	0.03 (0.066)
110 V AC/DC			CR-S024VADC1CRGZ	1SVR405541R3220			
			CR-S110VADC1CRGS	1SVR405541R6120			
230 V AC/DC			CR-S110VADC1CRGZ	1SVR405541R6220			
			CR-S230VADC1CRGS	1SVR405541R7120			
			CR-S230VADC1CRGZ	1SVR405541R7220			

¹⁾ If specified maximum values exceeded, the gold plating is destroyed. The maximum values of the standard contacts are then valid.

Ordering details - CR-S range sockets

Rated control supply voltage	Connection type	Type	Order code	Price	Pkg qty	Weight (1 pc) kg (lb)
6-24 V DC	Screw	CR-S006/024VDC1SS	1SVR405521R1100		10	0.025 (0.055)
	Spring	CR-S006/024VDC1SZ	1SVR405521R1200			
12-24 V AC/DC	Screw	CR-S012/024VADC1SS	1SVR405521R3100		10	0.025 (0.055)
	Spring	CR-S012/024VADC1SZ	1SVR405521R3200			
48-60 V AC/DC	Screw	CR-S048/060VADC1SS	1SVR405521R5100		10	0.025 (0.055)
	Spring	CR-S048/060VADC1SZ	1SVR405521R5200			
110-125 V AC/DC	Screw	CR-S110/125VADC1SS	1SVR405521R6100		10	0.025 (0.055)
	Spring	CR-S110/125VADC1SZ	1SVR405521R6200			
220-240 V AC/DC	Screw	CR-S220/240VADC1SS	1SVR405521R7100		10	0.025 (0.055)
	Spring	CR-S220/240VADC1SZ	1SVR405521R7200			

Ordering details - CR-S range accessories

Version	Type	Order code	Price	Pkg qty	Weight (1 pc) kg (lb)
Jumper bar 20 pole, blue color	CR-SJB20-BLUE	1SVR405598R0700		10	0.008 (0.018)
Jumper bar 20 pole, red color	CR-SJB20-RED	1SVR405598R0800			
Jumper bar 20 pole, black color	CR-SJB20-BLACK	1SVR405598R0900			
Marker block	CR-SM	1SNB041391R0610		10	0.0036 (0.0079)
Separator	CR-SSEP	1SVR405599R0000		10	0.012 (0.026)



Further documentation
CR-S Range on www.abb.com

Relay assemblies

Control voltage	Connection terminal	Contact material	Socket type	Socket order code	Relay type	Relay order code
5 V DC	screw	standard	CR-S006/024VDC1SS	1SVR405521R1100	CR-S005VDC1R	1SVR405501R1010
		gold plated	CR-S006/024VDC1SS	1SVR405521R1100	CR-S005VDC1RG	1SVR405501R1020
	spring	standard	CR-S006/024VDC1SZ	1SVR405521R1200	CR-S005VDC1R	1SVR405501R1010
		gold plated	CR-S006/024VDC1SZ	1SVR405521R1200	CR-S005VDC1RG	1SVR405501R1020
12 V DC	screw	standard	CR-S006/024VDC1SS or CR-S012/024VADC1SS	1SVR405521R1100 or 1SVR405521R3100	CR-S012VDC1R	1SVR405501R2010
		gold plated	CR-S006/024VDC1SS or CR-S012/024VADC1SS	1SVR405521R1100 or 1SVR405521R3100	CR-S012VDC1RG	1SVR405501R2020
		standard	CR-S006/024VDC1SZ or CR-S012/024VADC1SZ	1SVR405521R1200 or 1SVR405521R3200	CR-S012VDC1R	1SVR405501R2010
		gold plated	CR-S006/024VDC1SZ or CR-S012/024VADC1SZ	1SVR405521R1200 or 1SVR405521R3200	CR-S012VDC1RG	1SVR405501R2020
	spring	standard	CR-S012/024VADC1SS	1SVR405521R3100	CR-S012VDC1R	1SVR405501R2010
		gold plated	CR-S012/024VADC1SS	1SVR405521R3100	CR-S012VDC1RG	1SVR405501R2020
12 V AC	screw	standard	CR-S012/024VADC1SS	1SVR405521R3100	CR-S012VDC1R	1SVR405501R2010
		gold plated	CR-S012/024VADC1SS	1SVR405521R3100	CR-S012VDC1RG	1SVR405501R2020
		standard	CR-S012/024VADC1SZ	1SVR405521R3200	CR-S012VDC1R	1SVR405501R2010
		gold plated	CR-S012/024VADC1SZ	1SVR405521R3200	CR-S012VDC1RG	1SVR405501R2020
	spring	standard	CR-S012/024VADC1SS	1SVR405521R3100	CR-S012VDC1R	1SVR405501R2010
		gold plated	CR-S012/024VADC1SS	1SVR405521R3100	CR-S012VDC1RG	1SVR405501R2020
24 V DC	screw	standard	CR-S006/024VDC1SS or CR-S012/024VADC1SS	1SVR405521R1100 or 1SVR405521R3100	CR-S024VDC1R	1SVR405501R3010
		gold plated	CR-S006/024VDC1SS or CR-S012/024VADC1SS	1SVR405521R1100 or 1SVR405521R3100	CR-S024VDC1RG	1SVR405501R3020
		standard	CR-S006/024VDC1SZ or CR-S012/024VADC1SZ	1SVR405521R1200 or 1SVR405521R3200	CR-S024VDC1R	1SVR405501R3010
		gold plated	CR-S006/024VDC1SZ or CR-S012/024VADC1SZ	1SVR405521R1200 or 1SVR405521R3200	CR-S024VDC1RG	1SVR405501R3020
	spring	standard	CR-S012/024VADC1SS	1SVR405521R3100	CR-S024VDC1R	1SVR405501R3010
		gold plated	CR-S012/024VADC1SS	1SVR405521R3100	CR-S024VDC1RG	1SVR405501R3020
24 V AC	screw	standard	CR-S012/024VADC1SS	1SVR405521R3100	CR-S024VDC1R	1SVR405501R3010
		gold plated	CR-S012/024VADC1SS	1SVR405521R3100	CR-S024VDC1RG	1SVR405501R3020
		standard	CR-S012/024VADC1SZ	1SVR405521R3200	CR-S024VDC1R	1SVR405501R3010
		gold plated	CR-S012/024VADC1SZ	1SVR405521R3200	CR-S024VDC1RG	1SVR405501R3020
	spring	standard	CR-S012/024VADC1SS	1SVR405521R3100	CR-S024VDC1R	1SVR405501R3010
		gold plated	CR-S012/024VADC1SS	1SVR405521R3100	CR-S024VDC1RG	1SVR405501R3020
48 V AC/DC	screw	standard	CR-S048/060VADC1SS	1SVR405521R5100	CR-S048VDC1R	1SVR405501R4010
		gold plated	CR-S048/060VADC1SS	1SVR405521R5100	CR-S048VDC1RG	1SVR405501R4020
		standard	CR-S048/060VADC1SZ	1SVR405521R5200	CR-S048VDC1R	1SVR405501R4010
		gold plated	CR-S048/060VADC1SZ	1SVR405521R5200	CR-S048VDC1RG	1SVR405501R4020
	spring	standard	CR-S048/060VADC1SS	1SVR405521R5100	CR-S060VDC1R	1SVR405501R5010
		gold plated	CR-S048/060VADC1SS	1SVR405521R5100	CR-S060VDC1RG	1SVR405501R5020
60 V AC/DC	screw	standard	CR-S048/060VADC1SS	1SVR405521R5100	CR-S060VDC1R	1SVR405501R5010
		gold plated	CR-S048/060VADC1SS	1SVR405521R5100	CR-S060VDC1RG	1SVR405501R5020
		standard	CR-S048/060VADC1SZ	1SVR405521R5200	CR-S060VDC1R	1SVR405501R5010
		gold plated	CR-S048/060VADC1SZ	1SVR405521R5200	CR-S060VDC1RG	1SVR405501R5020
	spring	standard	CR-S110/125VADC1SS	1SVR405521R6100	CR-S060VDC1R	1SVR405501R5010
		gold plated	CR-S110/125VADC1SS	1SVR405521R6100	CR-S060VDC1RG	1SVR405501R5020
110-125 V AC/DC	screw	standard	CR-S110/125VADC1SS	1SVR405521R6100	CR-S060VDC1R	1SVR405501R5010
		gold plated	CR-S110/125VADC1SS	1SVR405521R6100	CR-S060VDC1RG	1SVR405501R5020
		standard	CR-S110/125VADC1SZ	1SVR405521R6200	CR-S060VDC1R	1SVR405501R5010
		gold plated	CR-S110/125VADC1SZ	1SVR405521R6200	CR-S060VDC1RG	1SVR405501R5020
	spring	standard	CR-S220/240VADC1SS	1SVR405521R7100	CR-S060VDC1R	1SVR405501R5010
		gold plated	CR-S220/240VADC1SS	1SVR405521R7100	CR-S060VDC1RG	1SVR405501R5020
220-240 V AC/DC	screw	standard	CR-S220/240VADC1SS	1SVR405521R7100	CR-S060VDC1R	1SVR405501R5010
		gold plated	CR-S220/240VADC1SS	1SVR405521R7100	CR-S060VDC1RG	1SVR405501R5020
		standard	CR-S220/240VADC1SZ	1SVR405521R7200	CR-S060VDC1R	1SVR405501R5010
		gold plated	CR-S220/240VADC1SZ	1SVR405521R7200	CR-S060VDC1RG	1SVR405501R5020
	spring	standard	CR-S220/240VADC1SS	1SVR405521R7100	CR-S060VDC1R	1SVR405501R5010
		gold plated	CR-S220/240VADC1SS	1SVR405521R7100	CR-S060VDC1RG	1SVR405501R5020

Optocoupler assemblies

Control voltage	Connection terminal	Output characteristics	Socket type	Socket order code	Opto type	Opto order code
24 V DC	screw	Transistor 100 mA - 48 V DC	CR-S012/024VADC1SS	1SVR405521R3100	CR-S024VDC1TRA	1SVR405501R3050
			CR-S012/024VADC1SZ	1SVR405521R3200	CR-S024VDC1TRA	1SVR405501R3050
	spring	MOS-FET 2 A - 24 V DC	CR-S012/024VADC1SS	1SVR405521R3100	CR-S024VDC1MOS	1SVR405501R3060
			CR-S012/024VADC1SZ	1SVR405521R3200	CR-S024VDC1MOS	1SVR405501R3060
	screw	Triac 2 A - 240 V AC	CR-S012/024VADC1SS	1SVR405521R3100	CR-S024VDC1TRI	1SVR405501R3070
			CR-S012/024VADC1SZ	1SVR405521R3200	CR-S024VDC1TRI	1SVR405501R3070

How to use the selection table

- Choose the desired control supply voltage from the column "Control voltage" e.g. 5 V DC.
- Choose the desired kind of connection terminal from the column "Connection Terminal" e.g. spring.
- Choose the desired material of contact from the column "Contact Material" e.g. gold plated.

Control voltage	Connection terminal	Contact material	Socket type	Socket order code	Relay type	Relay order code
5 V DC	screw	standard	CR-S006/024VDC1SS	1SVR405521R1100	CR-S005VDC1R	1SVR405501R1010
		gold plated	CR-S006/024VDC1SS	1SVR405521R1100	CR-S005VDC1RG	1SVR405501R1020
	spring	standard	CR-S006/024VDC1SZ	1SVR405521R1200	CR-S005VDC1R	1SVR405501R1010
		gold plated	CR-S006/024VDC1SZ	1SVR405521R1200	CR-S005VDC1RG	1SVR405501R1020
12 V AC	screw	standard	CR-S012/024VADC1SS	1SVR405521R3100	CR-S012VDC1R	1SVR405501R2010
		gold plated	CR-S012/024VADC1SS	1SVR405521R3100	CR-S012VDC1RG	1SVR405501R2020
		standard	CR-S012/024VADC1SZ	1SVR405521R3200	CR-S012VDC1R	1SVR405501R2010
		gold plated	CR-S012/024VADC1SZ	1SVR405521R3200	CR-S012VDC1RG	1SVR405501R2020
	spring	standard	CR-S012/024VADC1SS	1SVR405521R3100	CR-S012VDC1R	1SVR405501R2010
		gold plated	CR-S012/024VADC1SS	1SVR405521R3100	CR-S012VDC1RG	1SVR405501R2020

Example: When you have chosen **5 V DC** as Control supply voltage, **spring** connection as Connection Terminal and **gold plated** as Contact Material the following order codes and type designators are valid:

Socket: CR-S006/024VDC1SZ, 1SVR405521R1200 Relay: CR-S005VDC1RG, 1SVR405501R1020

Pluggable interface relays and optocouplers

Ordering details - CR-P range



CR-P relay

2CDC 291 0A5 F0004

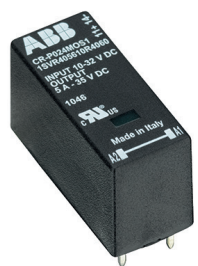

CR-P optocoupler

2CDC 291 006 S0016



CR-PLS

2CDC 291 006 F0011

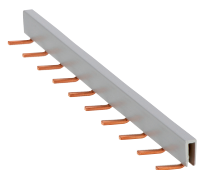

CR-PJ

2CDC 291 004 F0007



Further documentation
CR-P range on www.abb.com

Ordering details - CR-P range relays

Rated control supply voltage	Outputs	Contact ratings	Type	Order code	Price	Pkg	Weight (1 pc)
						qty	kg (lb)
12 V DC	1 c/o (SPDT)	250 V, 16 A	CR-P012DC1	1SVR405600R4000		10	0.014 (0.031)
24 V DC			CR-P024DC1	1SVR405600R1000			
48 V DC			CR-P048DC1	1SVR405600R6000			
110 V DC			CR-P110DC1	1SVR405600R8000			
24 V AC			CR-P024AC1	1SVR405600R0000			
48 V AC			CR-P048AC1	1SVR405600R5000			
110 V AC			CR-P110AC1	1SVR405600R7000			
120 V AC			CR-P120AC1	1SVR405600R2000			
230 V AC			CR-P230AC1	1SVR405600R3000			
12 V DC			2 c/o (SPDT)	250 V, 8 A	CR-P012DC2		
24 V DC	CR-P024DC2	1SVR405601R1000					
48 V DC	CR-P048DC2	1SVR405601R6000					
110 V DC	CR-P110DC2	1SVR405601R8000					
24 V AC	CR-P024AC2	1SVR405601R0000					
48 V AC	CR-P048AC2	1SVR405601R5000					
110 V AC	CR-P110AC2	1SVR405601R7000					
120 V AC	CR-P120AC2	1SVR405601R2000					
230 V AC	CR-P230AC2	1SVR405601R3000					

Ordering details - CR-P range relays with gold contacts

Rated control supply voltage	Outputs	Contact ratings	Type	Order code	Price	Pkg	Weight (1 pc)
						qty	kg (lb)
24 V DC	2 c/o (SPDT) gold contact	250 V, 8 A	CR-P024DC2	1SVR405606R1000		10	0.014 (0.031)
24 V AC			CR-P024AC2G	1SVR405606R0000			
110 V AC			CR-P110AC2G	1SVR405606R7000			
230 V AC			CR-P230AC2G	1SVR405606R3000			

Ordering details - CR-P range pluggable optocouplers

Rated control supply voltage (Us)	Outputs	Type	Order code	Price	Pkg	Weight (1 pc)
					qty	kg (lb)
10-32 V DC	MOS-FET, 5 A - 35 V DC	CR-P024MOS1	1SVR405610R4060		10	0.011 (0.618)
	Triac, 3 A - 275 V AC	CR-P024TRI1	1SVR405610R4070			

Ordering details - Accessories

Version	Connection terminal	Type	Order code	Price	Pkg	Weight (1 pc)
					qty	kg (lb)
Logical socket with protective separation	screw	CR-PLS	1SVR405650R0000		10	0.045 (0.099)
	screw	CR-PLSx	1SVR405650R0100			0.043 (0.095)
Logical socket	spring	CR-PLC	1SVR405650R0200		10	0.042 (0.093)
	screw	CR-PSS	1SVR405650R1000			0.038 (0.084)
Plastic holder for socket		CR-PH	1SVR405659R0000		10	0.002 (0.004)
Jumper bar for sockets with screw connection		CR-PJ	1SVR405658R5000			0.018 (0.040)
Marker		CR-PM	1SVR405658R0000		10	0.0002 (0.0004)

Pluggable interface relays and optocouplers

Ordering details - CR-M range



CR-M

2CDC 291 002 F0015

Ordering details - CR-M range without LED

Rated control supply voltage	Outputs	Contact ratings	Type	Order code	Price	Pkg	Weight
						qty	(1 pc) kg (lb)
12 V DC	2 c/o (SPDT)	250 V, 12 A	CR-M012DC2	1SVR405611R4000		10	0.033 (0.073)
24 V DC			CR-M024DC2	1SVR405611R1000			
48 V DC			CR-M048DC2	1SVR405611R6000			
60 V DC			CR-M060DC2	1SVR405611R4200			
110 V DC			CR-M110DC2	1SVR405611R8000			
125 V DC			CR-M125DC2	1SVR405611R8200			
220 V DC			CR-M220DC2	1SVR405611R9000			
24 V AC			CR-M024AC2	1SVR405611R0000			
48 V AC			CR-M048AC2	1SVR405611R5000			
110 V AC			CR-M110AC2	1SVR405611R7000			
120 V AC			CR-M120AC2	1SVR405611R2000			
230 V AC			CR-M230AC2	1SVR405611R3000			
12 V DC			3 c/o (SPDT)	250 V, 10 A	CR-M012DC3		
24 V DC	CR-M024DC3	1SVR405612R1000					
48 V DC	CR-M048DC3	1SVR405612R6000					
60 V DC	CR-M060DC3	1SVR405612R4200					
110 V DC	CR-M110DC3	1SVR405612R8000					
125 V DC	CR-M125DC3	1SVR405612R8200					
220 V DC	CR-M220DC3	1SVR405612R9000					
24 V AC	CR-M024AC3	1SVR405612R0000					
48 V AC	CR-M048AC3	1SVR405612R5000					
60 V AC	CR-M060AC3	1SVR405612R5200					
110 V AC	CR-M110AC3	1SVR405612R7000					
120 V AC	CR-M120AC3	1SVR405612R2000					
230 V AC	CR-M230AC3	1SVR405612R3000					
12 V DC	4 c/o (SPDT)	250 V, 6 A	CR-M012DC4	1SVR405613R4000		10	0.033 (0.073)
24 V DC			CR-M024DC4	1SVR405613R1000			
48 V DC			CR-M048DC4	1SVR405613R6000			
60 V DC			CR-M060DC4	1SVR405613R4200			
110 V DC			CR-M110DC4	1SVR405613R8000			
125 V DC			CR-M125DC4	1SVR405613R8200			
220 V DC			CR-M220DC4	1SVR405613R9000			
24 V AC			CR-M024AC4	1SVR405613R0000			
48 V AC			CR-M048AC4	1SVR405613R5000			
110 V AC			CR-M110AC4	1SVR405613R7000			
120 V AC			CR-M120AC4	1SVR405613R2000			
230 V AC			CR-M230AC4	1SVR405613R3000			



Further documentation
CR-M range on www.abb.com

Pluggable interface relays and optocouplers

Ordering details - CR-M range



CR-M

2CDC 291 002 F0015

Ordering details - CR-M range with LED

Rated control supply voltage	Outputs	Contact ratings	Type	Order code	Price	Pkg qty	Weight (1 pc) kg (lb)				
12 V DC	2 c/o (SPDT)	250 V, 12 A	CR-M012DC2L	1SVR405611R4100		10	0.033 (0.073)				
24 V DC			CR-M024DC2L	1SVR405611R1100							
48 V DC			CR-M048DC2L	1SVR405611R6100							
60 V DC			CR-M060DC2L	1SVR405611R4300							
110 V DC			CR-M110DC2L	1SVR405611R8100							
125 V DC			CR-M125DC2L	1SVR405611R8300							
220 V DC			CR-M220DC2L	1SVR405611R9100							
24 V AC			CR-M024AC2L	1SVR405611R0100							
48 V AC			CR-M048AC2L	1SVR405611R5100							
110 V AC			CR-M110AC2L	1SVR405611R7100							
120 V AC			CR-M120AC2L	1SVR405611R2100							
230 V AC			CR-M230AC2L	1SVR405611R3100							
12 V DC			3 c/o (SPDT)	250 V, 10 A	CR-M012DC3L			1SVR405612R4100		10	0.033 (0.073)
24 V DC					CR-M024DC3L			1SVR405612R1100			
48 V DC	CR-M048DC3L	1SVR405612R6100									
60 V DC	CR-M060DC3L	1SVR405612R4300									
110 V DC	CR-M110DC3L	1SVR405612R8100									
125 V DC	CR-M125DC3L	1SVR405612R8300									
220 V DC	CR-M220DC3L	1SVR405612R9100									
24 V AC	CR-M024AC3L	1SVR405612R0100									
48 V AC	CR-M048AC3L	1SVR405612R5100									
110 V AC	CR-M110AC3L	1SVR405612R7100									
120 V AC	CR-M120AC3L	1SVR405612R2100									
230 V AC	CR-M230AC3L	1SVR405612R3100									
12 V DC	4 c/o (SPDT)	250 V, 6 A			CR-M012DC4L	1SVR405613R4100		10	0.033 (0.073)		
24 V DC					CR-M024DC4L	1SVR405613R1100					
48 V DC			CR-M048DC4L	1SVR405613R6100							
60 V DC			CR-M060DC4L	1SVR405613R4300							
110 V DC			CR-M110DC4L	1SVR405613R8100							
125 V DC			CR-M125DC4L	1SVR405613R8300							
220 V DC			CR-M220DC4L	1SVR405613R9100							
24 V AC			CR-M024AC4L	1SVR405613R0100							
48 V AC			CR-M048AC4L	1SVR405613R5100							
110 V AC			CR-M110AC4L	1SVR405613R7100							
120 V AC			CR-M120AC4L	1SVR405613R2100							
230 V AC			CR-M230AC4L	1SVR405613R3100							

Ordering details - CR-M range with LED and free-wheeling diode

Rated control supply voltage	Outputs	Contact ratings	Type	Order code	Price	Pkg qty	Weight (1 pc) kg (lb)
24 V DC	4 c/o (SPDT)	250 V, 6 A	CR-M024DC4LD	1SVR405614R1100		10	0.033 (0.073)

Ordering details - CR-M range with gold contacts

Rated control supply voltage	Outputs	Contact ratings	Type	Order code	Price	Pkg qty	Weight (1 pc) kg (lb)
24 V DC	4 c/o (SPDT)	250 V, 6 A	CR-M024DC4G	1SVR405618R1000		10	0.033 (0.073)
24 V AC			CR-M024AC4G	1SVR405618R0000			
110 V AC			CR-M110AC4G	1SVR405618R7000			
230 V AC			CR-M230AC4G	1SVR405618R3000			

Pluggable interface relays and optocouplers

Ordering details - CR-M range



2CDC 291 009 F0015

CR-M

Ordering details – CR-M range with gold contacts and LED

Rated control supply voltage	Outputs	Contact ratings	Type	Order code	Price	Pkg	Weight (1 pc)
						qty	kg (lb)
12 V DC	4 c/o (SPDT)	250 V / 6 A	CR-M012DC4LG	1SVR405618R4100		10	0.033 (0.073)
24 V DC			CR-M024DC4LG	1SVR405618R1100			
48 V DC			CR-M048DC4LG	1SVR405618R6100			
60 V DC			CR-M060DC4LG	1SVR405618R4300			
110 V DC			CR-M110DC4LG	1SVR405618R8100			
125 V DC			CR-M125DC4LG	1SVR405618R8300			
220 V DC			CR-M220DC4LG	1SVR405618R9100			
24 V AC			CR-M024AC4LG	1SVR405618R0100	10	0.033 (0.073)	
48 V AC			CR-M048AC4LG	1SVR405618R5100			
110 V AC			CR-M110AC4LG	1SVR405618R7100			
120 V AC			CR-M120AC4LG	1SVR405618R2100			
230 V AC			CR-M230AC4LG	1SVR405618R3100			

Ordering details – CR-M range with gold contacts, LED and free-wheeling diode

Rated control supply voltage	Outputs	Contact ratings	Type	Order code	Price	Pkg	Weight (1 pc)
						qty	kg (lb)
12 V DC	4 c/o (SPDT)		CR-M012DC4LDG	1SVR405618R4400		10	0.033 (0.073)
24 V DC			CR-M024DC4LDG	1SVR405618R1400			



2CDC 291 009 F0011

CR-M4SS

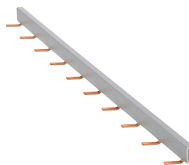

2CDC 291 008 F0007

CR-MJ

Ordering details - Accessories

Version	Connection terminal	Type	Order code	Price	Pkg	Weight (1 pc)
					qty	kg (lb)
Logical socket for 2 c/o	screw	CR-M2LS	1SVR405651R1100		10	0.055 (0.121)
Logical socket for 3 c/o		CR-M3LS	1SVR405651R2100			0.062 (0.137)
Logical socket for 2/4 c/o		CR-M4LS	1SVR405651R3100			0.066 (0.146)
Logical socket for 2 c/o	spring	CR-M2LC	1SVR405651R1200		10	0.065 (0.143)
Logical socket for 2/4 c/o		CR-M4LC	1SVR405651R3200			0.066 (0.146)
Standard socket for 2 c/o	screw	CR-M2SS	1SVR405651R1000		10	0.066 (0.146)
Standard socket for 3 c/o		CR-M3SS	1SVR405651R2000			0.068 (0.150)
Standard socket for 2/4 c/o		CR-M4SS	1SVR405651R3000			0.070 (0.154)
Standard socket for 2 c/o	fork type	CR-M2SF	1SVR405651R1300		10	0.040 (0.088)
Standard socket for 2/4 c/o		CR-M4SF	1SVR405651R3300			0.048 (0.106)
Plastic holder		CR-MH	1SVR405659R1000		10	0.003 (0.007)
Metal holder		CR-MH1	1SVR405659R1100		10	0.0005 (0.001)
Jumper bar for sockets with screw connection		CR-MJ	1SVR405658R6000		10	0.029 (0.064)
Marker		CR-MM	1SVR405658R1000		10	0.0005 (0.001)
Plug for test button replacement		CR-MP	1SVR405658R2000		100	0.001 kg (0.002 lb)

Pluggable interface relays and optocouplers

Ordering details - CR-P/M function modules



CR-P/M ...

2CDC 281 005 S0011

Ordering details - CR-P/M range

Rated control supply voltage	Description	Version	Type	Order code	Price	Pkg	Weight
						qty	(1 pc) kg (lb)
6-220 V DC	Diode - Reverse polarity protection/free wheeling diode	A1+, A2-	CR-P/M 22	1SVR405651R0000		10	0.003 (0.007)
6-24 V DC	Diode and LED - Reverse polarity protection/free wheeling diode	red, A1+, A2-	CR-P/M 42	1SVR405652R0000		10	0.003 (0.007)
		green, A1+, A2-	CR-P/M 42V	1SVR405652R1000			
24-60 V DC	Diode and LED - Reverse polarity protection/free wheeling diode	red, A1+, A2-	CR-P/M 42B	1SVR405652R4000		10	0.003 (0.007)
		green, A1+, A2-	CR-P/M 42BV	1SVR405652R4100			
110 V DC	Diode and LED - Reverse polarity protection/free wheeling diode	red, A1+, A2-	CR-P/M 42C	1SVR405652R9000		10	0.003 (0.007)
		green, A1+, A2-	CR-P/M 42CV	1SVR405652R9100			
6-24 V AC/DC	Spark quenching		CR-P/M 52B	1SVR405653R0000		10	0.003 (0.007)
24-60 V AC/DC			CR-P/M 52D	1SVR405653R4000			
110 V AC/DC			CR-P/M 52C	1SVR405653R1000			
6-24 V AC/DC	Diode, LED and reverse polarity protection	red, for DC A1+, A2-	CR-P/M 62	1SVR405654R0000		10	0.003 (0.007)
		green, for DC A1+, A2-	CR-P/M 62V	1SVR405654R1000			
24-60 V AC/DC	Diode, LED and reverse polarity protection	red, for DC A1+, A2-	CR-P/M 62E	1SVR405654R4000		10	0.003 (0.007)
		green, for DC A1+, A2-	CR-P/M 62EV	1SVR405654R4100			
110 V DC 110-230 V AC	Diode, LED and reverse polarity protection	red, for DC A1+, A2-	CR-P/M 92	1SVR405654R0100		10	0.003 (0.007)
		green, for DC A1+, A2-	CR-P/M 92V	1SVR405654R1100			
6-24 V AC/DC	Varistor and LED Overvoltage protection	red, for DC A1+, A2-	CR-P/M 62C	1SVR405655R0000		10	0.003 (0.007)
		green, for DC A1+, A2-	CR-P/M 62CV	1SVR405655R1000			
24-60 V AC/DC	Varistor and LED Overvoltage protection	red, for DC A1+, A2-	CR-P/M 62D	1SVR405655R4000		10	0.003 (0.007)
		green, for DC A1+, A2-	CR-P/M 62DV	1SVR405655R4100			
110 V DC 110-230 V AC	Varistor and LED Overvoltage protection	red, for DC A1+, A2-	CR-P/M 92C	1SVR405655R0100		10	0.003 (0.007)
		green, for DC A1+, A2-	CR-P/M 92CV	1SVR405655R1100			
24 V AC	Overvoltage protection		CR-P/M 72	1SVR405656R0000		10	0.002 (0.004)
115 V AC			CR-P/M 72A	1SVR405656R1000			
230 V AC			CR-P/M 82	1SVR405656R2000			

Connection diagrams

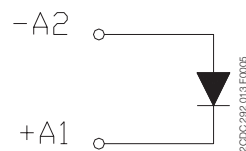

CR-P/M 22

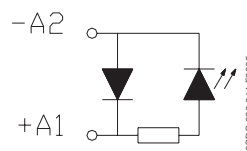

CR-P/M 42, CR-P/M 42C, CR-P/M 42BV, CR-P/M 42B, CR-P/M 42V, CR-P/M 42CV

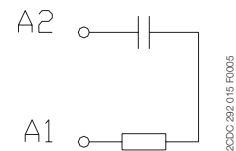

CR-P/M 52B, CR-P/M 52D, CR-P/M 52C

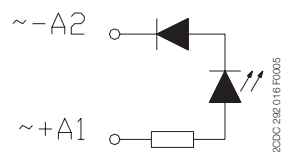

CR-P/M 62, CR-P/M 92, CR-P/M 62E, CR-P/M 62V, CR-P/M 62EV, CR-P/M 92V

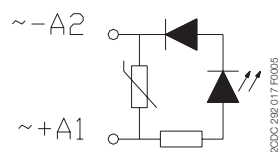

CR-P/M 62C, CR-P/M 92C, CR-P/M 62D, CR-P/M 62DV, CR-P/M 62V, CR-P/M 62CV, CR-P/M 92CV

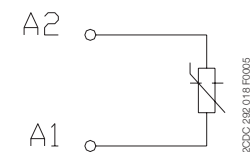

CR-P/M 72, CR-P/M 72A, CR-P/M 82

Pluggable interface relays and optocouplers

Ordering details - CR-U range



CR-U



CR-U2S

Ordering details - CR-U range without LED

Rated control supply voltage	Outputs	Contact ratings	Type	Order code	Price	Pkg qty	Weight (1 pc) kg (lb)
12 V DC	2 c/o (SPDT)	250 V, 10 A	CR-U012DC2	1SVR405621R4000		10	0.083 (0.183)
24 V DC			CR-U024DC2	1SVR405621R1000			
48 V DC			CR-U048DC2	1SVR405621R6000			
110 V DC			CR-U110DC2	1SVR405621R8000			
220 V DC			CR-U220DC2	1SVR405621R9000			
24 V AC			CR-U024AC2	1SVR405621R0000			
48 V AC			CR-U048AC2	1SVR405621R5000			
110 V AC			CR-U110AC2	1SVR405621R7000			
120 V AC			CR-U120AC2	1SVR405621R2000			
230 V AC			CR-U230AC2	1SVR405621R3000			
12 V DC	3 c/o (SPDT)	250 V, 10 A	CR-U012DC3	1SVR405622R4000		10	0.083 (0.183)
24 V DC			CR-U024DC3	1SVR405622R1000			
48 V DC			CR-U048DC3	1SVR405622R6000			
110 V DC			CR-U110DC3	1SVR405622R8000			
125 V DC			CR-U125DC3	1SVR405622R8200			
220 V DC			CR-U220DC3	1SVR405622R9000			
24 V AC			CR-U024AC3	1SVR405622R0000			
48 V AC			CR-U048AC3	1SVR405622R5000			
60 V AC			CR-U060AC3	1SVR405622R5200			
110 V AC			CR-U110AC3	1SVR405622R7000			
120 V AC	CR-U120AC3	1SVR405622R2000					
230 V AC	CR-U230AC3	1SVR405622R3000					

Ordering details - CR-U range with LED

Rated control supply voltage	Outputs	Contact ratings	Type	Order code	Price	Pkg qty	Weight (1 pc) kg (lb)
12 V DC	2 c/o (SPDT)	250 V, 10 A	CR-U012DC2L	1SVR405621R4100		10	0.083 (0.183)
24 V DC			CR-U024DC2L	1SVR405621R1100			
48 V DC			CR-U048DC2L	1SVR405621R6100			
110 V DC			CR-U110DC2L	1SVR405621R8100			
220 V DC			CR-U220DC2L	1SVR405621R9100			
24 V AC			CR-U024AC2L	1SVR405621R0100			
48 V AC			CR-U048AC2L	1SVR405621R5100			
110 V AC			CR-U110AC2L	1SVR405621R7100			
120 V AC			CR-U120AC2L	1SVR405621R2100			
230 V AC			CR-U230AC2L	1SVR405621R3100			
12 V DC	3 c/o (SPDT)	250 V, 10 A	CR-U012DC3L	1SVR405622R4100		10	0.083 (0.183)
24 V DC			CR-U024DC3L	1SVR405622R1100			
48 V DC			CR-U048DC3L	1SVR405622R6100			
110 V DC			CR-U110DC3L	1SVR405622R8100			
220 V DC			CR-U220DC3L	1SVR405622R9100			
24 V AC			CR-U024AC3L	1SVR405622R0100			
48 V AC			CR-U048AC3L	1SVR405622R5100			
110 V AC			CR-U110AC3L	1SVR405622R7100			
120 V AC			CR-U120AC3L	1SVR405622R2100			
230 V AC			CR-U230AC3L	1SVR405622R3100			

Ordering details - Accessories

Version	Type	Order code	Price	Pkg qty	Weight (1 pc) kg (lb)
Socket for 2 c/o and module	CR-U2S	1SVR405670R0000		10	
Socket for 3 c/o and module	CR-U3S	1SVR405660R0000			
Socket for 3 c/o	CR-U3E	1SVR405660R0100			
Socket small for 2 c/o	CR-U2SM	1SVR405670R1100			
Socket small for 3 c/o	CR-U3SM	1SVR405660R1100			
Holder for CR-U socket	CR-UH	1SVR405669R0000			



Further documentation
CR-U range on www.abb.com

Pluggable interface relays and optocouplers

Ordering details - CR-U function modules

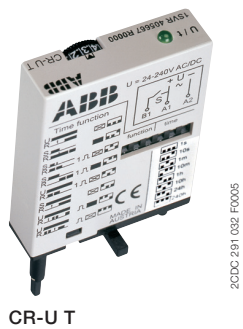

Ordering details - CR-U range

Rated control supply voltage	Description	Version	Type	Order code	Price	Pkg qty	Weight
							(1 pc)
							kg (lb)
6-220 V DC	Diode - Reverse polarity protection/free wheeling diode	A1+, A2-	CR-U 21	1SVR405661R0000		10	0.007 (0.015)
6-24 V DC	Diode and LED - Reverse polarity protection/free wheeling diode	red, A1+, A2-	CR-U 41	1SVR405662R0000		10	0.007 (0.015)
24-60 V DC		green, A1+, A2-	CR-U 41V	1SVR405662R1000			
110 V DC		red, A1+, A2-	CR-U 41B	1SVR405662R4000			
		green, A1+, A2-	CR-U 41BV	1SVR405662R4100			
		red, A1+, A2-	CR-U 41C	1SVR405662R9000			
6-24 V AC/DC	Spark quenching	green, A1+, A2-	CR-U 41CV	1SVR405662R9100		10	0.007 (0.015)
24-60 V AC/DC			CR-U 51B	1SVR405663R0000			
110 V AC/DC			CR-U 51D	1SVR405663R4000			
6-24 V AC/DC	Diode and LED	red, for DC A1+, A2-	CR-U 61	1SVR405664R0000		10	0.007 (0.015)
		green, for DC A1+, A2-	CR-U 61V	1SVR405664R1000			
		red, for DC A1+, A2-	CR-U 61E	1SVR405664R4000			
		green, for DC A1+, A2-	CR-U 61EV	1SVR405664R4100			
110 V DC 110-230 V AC		red, for DC A1+, A2-	CR-U 91	1SVR405664R0100		10	0.007 (0.015)
		green, for DC A1+, A2-	CR-U 91V	1SVR405664R1100			
6-24 V AC/DC	Varistor and LED Overvoltage protection	red, for DC A1+, A2-	CR-U 61C	1SVR405665R0000		10	0.007 (0.015)
		green, for DC A1+, A2-	CR-U 61CV	1SVR405665R1000			
		red, for DC A1+, A2-	CR-U 61D	1SVR405665R4000			
24-60 V AC/DC		green, for DC A1+, A2-	CR-U 61DV	1SVR405665R4100		10	0.007 (0.015)
		red, for DC A1+, A2-	CR-U 91C	1SVR405665R0100			
110 V DC 110-230 V AC		green, for DC A1+, A2-	CR-U 91CV	1SVR405665R1100		10	0.007 (0.015)
		red, for DC A1+, A2-	CR-U 71	1SVR405666R0000			
		24 V AC	Overvoltage protection, varistor	CR-U 71A			
115 V AC	CR-U 81	1SVR405666R2000					
230 V AC							
24-240 V AC/DC	Multifunction time module	pluggable onto CR-U2S and CR-U3S	CR-U T	1SVR405667R0000		10	0.014 (0.031)

All CR-U modules can be plugged onto sockets CR-U2S and CR-U3S.

Connection diagrams

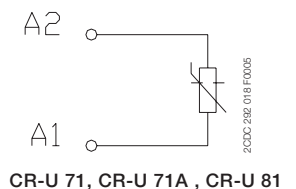
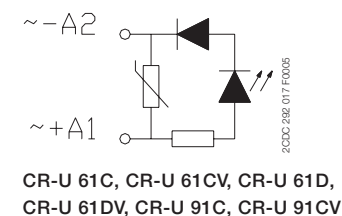
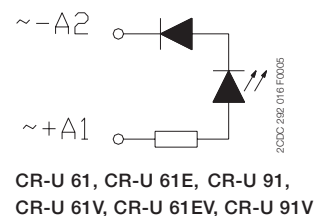
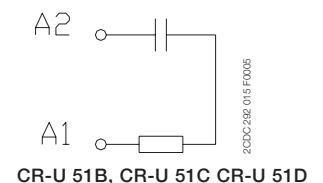
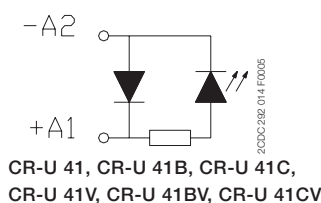
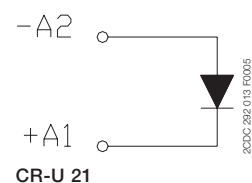

Pluggable interface relays and optocouplers

Technical data - CR-P, CR-M, CR-U

Input circuit - coil data

CR-P range



	Rated control supply voltage U_s	Rated frequency	Make voltage (at 20 °C)	Maximum voltage (at 55 °C)	Break voltage	Rated power	Coil resistance (at 20 °C)	Tolerance of coil resistance
DC coils	12 V DC 24 V DC 48 V DC 110 V DC	- - - -	8.4 V DC 16.8 V DC 33.6 V DC 77 V DC	30.6 V DC 61.2 V DC 122.4 V DC 280 V DC	$\geq 0.1 U_s$ $\geq 0.1 U_s$ $\geq 0.1 U_s$ $\geq 0.1 U_s$	0.4-0.48 W 0.4-0.48 W 0.4-0.48 W 0.4-0.48 W	360 Ω 1440 Ω 5700 Ω 25200 Ω	$\pm 10\%$ $\pm 10\%$ $\pm 10\%$ $\pm 10\%$
AC coils	24 V AC 48 V AC 110 V AC 120 V AC 230 V AC	50 / 60 Hz 50 / 60 Hz 50 / 60 Hz 50 / 60 Hz 50 / 60 Hz	19.2 V AC 38.4 V AC 88 V AC 96 V AC 184 V AC	28.8 V AC 57.6 V AC 132 V AC 144 V AC 276 V AC	$\geq 0.15 U_s$ $\geq 0.15 U_s$ $\geq 0.15 U_s$ $\geq 0.15 U_s$ $\geq 0.15 U_s$	0.75 VA 0.75 VA 0.75 VA 0.75 VA 0.75 VA	400 Ω 1550 Ω 8900 Ω 10200 Ω 38500 Ω	$\pm 10\%$ $\pm 10\%$ $\pm 10\%$ $\pm 10\%$ $\pm 10\%$

5

CR-M range



	Rated control supply voltage U_s	Rated frequency	Make voltage (at 20 °C)	Maximum voltage (at 55 °C)	Break voltage	Rated power	Coil resistance (at 20 °C)	Tolerance of coil resistance
DC coils	12 V DC 24 V DC 48 V DC 60 V DC 110 V DC 125 V DC 220 V DC	- - - - - - -	9.6 V DC 19.2 DC 38.4 V DC 48 V DC 88 V DC 100 V DC 176 V DC	13.2 V DC 26.4 V DC 52.8 V DC 66 V DC 121 V DC 137.5 V DC 242 V DC	$\geq 0.1 U_s$ $\geq 0.1 U_s$ $\geq 0.1 U_s$ $\geq 0.1 U_s$ $\geq 0.1 U_s$ $\geq 0.1 U_s$ $\geq 0.1 U_s$	0.9 W 0.9 W 0.9 W 0.9 W 0.9 W 0.9 W 0.9 W	160 Ω 640 Ω 2600 Ω 4000 Ω 13600 Ω 16000 Ω 54000 Ω	$\pm 10\%$ $\pm 10\%$ $\pm 10\%$ $\pm 10\%$ $\pm 10\%$ $\pm 10\%$ $\pm 10\%$
AC coils	24 V AC 48 V AC 60 V AC 110 V AC 120 V AC 230 V AC	50 / 60 Hz 50 / 60 Hz 50 / 60 Hz 50 / 60 Hz 50 / 60 Hz 50 / 60 Hz	19.2 V AC 38.4 V AC 48 V AC 88 V AC 96 V AC 184 V AC	26.4 V AC 52.8 V AC 66 V AC 121 V AC 132 V AC 253 V AC	$\geq 0.2 U_s$ $\geq 0.2 U_s$ $\geq 0.2 U_s$ $\geq 0.2 U_s$ $\geq 0.2 U_s$ $\geq 0.2 U_s$	1.6 VA 1.6 VA 1.6 VA 1.6 VA 1.6 VA 1.6 VA	158 Ω 640 Ω 930 Ω 3450 Ω 3770 Ω 16100 Ω	$\pm 10\%$ $\pm 10\%$ $\pm 10\%$ $\pm 10\%$ $\pm 10\%$ $\pm 10\%$

CR-U range



	Rated control supply voltage U_s	Rated frequency	Make voltage (at 20 °C)	Maximum voltage (at 55 °C)	Break voltage	Rated power	Coil resistance (at 20 °C)	Tolerance of coil resistance
DC coils	12 V DC 24 V DC 48 V DC 110 V DC 125 V DC 220 V DC	- - - - - -	9.6 V DC 19.2 V DC 38.4 V DC 88.0 V DC 100 V DC 176.0 V DC	13.2 V DC 26.4 V DC 52.8 V DC 121.0 V DC 137.5 V DC 242.0 V DC	$\geq 0.1 U_s$ $\geq 0.1 U_s$ $\geq 0.1 U_s$ $\geq 0.1 U_s$ $\geq 0.1 U_s$ $\geq 0.1 U_s$	1.5 W 1.5 W 1.5 W 1.5 W 1.5 W 1.5 W	110 Ω 430 Ω 1750 Ω 9200 Ω 11000 Ω 37000 Ω	$\pm 10\%$ $\pm 10\%$ $\pm 10\%$ $\pm 10\%$ $\pm 10\%$ $\pm 10\%$
AC coils	24 V AC 48 V AC 60 V AC 110 V AC 120 V AC 230 V AC	50 / 60 Hz 50 / 60 Hz 50 / 60 Hz 50 / 60 Hz 50 / 60 Hz 50 / 60 Hz	19.2 V AC 38.4 V AC 48.0 V AC 88.0 V AC 96.0 V AC 184.0 V AC	26.4 V AC 52.8 V AC 66.0 V AC 121.0 V AC 132.0 V AC 253.0 V AC	$\geq 0.15 U_s$ $\geq 0.15 U_s$ $\geq 0.15 U_s$ $\geq 0.15 U_s$ $\geq 0.15 U_s$ $\geq 0.15 U_s$	2.8 VA (50 Hz) 2.5 VA (60 Hz) 2.8 VA (50 Hz) 2.5 VA (60 Hz) 2.8 VA (50 Hz) 2.5 VA (60 Hz) 2.8 VA (50 Hz) 2.5 VA (60 Hz) 2.8 VA (50 Hz) 2.5 VA (60 Hz) 2.8 VA (50 Hz) 2.5 VA (60 Hz)	75 Ω 305 Ω 475 Ω 1700 Ω 1910 Ω 7080 Ω	$\pm 10\%$ $\pm 10\%$ $\pm 10\%$ $\pm 10\%$ $\pm 10\%$ $\pm 10\%$

Pluggable interface relays and optocouplers

Technical data - CR-P, CR-M, CR-U

Type		CR-P...1	CR-P...2	CR-M...2	CR-M...3	CR-M...4	CR-U...2	CR-U...3
Output circuit(s)		11-12/14	11-12/14 21-22/24	11-12/14 21-22/24	11-12/14 21-22/24 31-32/34	11-12/14 21-22/24 31-32/34 41-42/44	11-12/14 31-32/34	11-12/14 21-22/24 31-32/34
Kind of output		Relay, 1 c/o	Relay, 2 c/o	Relay, 2 c/o	Relay, 3 c/o	Relay, 4 c/o	Relay, 2 c/o	Relay, 3 c/o
Contact material		AgNi	AgNi AgNi/Au 5 µm	AgNi	AgNi	AgNi AgNi/Au 5 µm	AgNi	
Rated operational voltage U _e (VDE 0110, IEC 60947-1)		250 V						
Minimum switching voltage		5 V			10 V (AgNi); 5 V (AgNi/Au)		10 V	
Maximum switching voltage	DC	300 V DC			250 V DC			
	AC	440 V AC			250 V AC		440 V AC	
Minimum switching current		5 mA (AgNi), 2 mA (AgNi/Au)		5 mA (AgNi)	5 mA (AgNi)	2 mA (AgNi/Au)	5 mA	
Rated free air thermal current I _{th}		16 A	8 A	12 A	10 A	6 A	10 A	
Rated operational current (IEC 60947-5-1)	AC-12 (resistive) 230 V	16 A	8 A	12 A	10 A	6 A	10 A	
	AC-15 (inductive) 230 V	1.5 A	1.5 A	1.5 A	1.5 A	1 A	1.5 A	
	AC-15 (inductive) 120 V	3 A				1.5 A	3 A	
	DC-12 (resistive) 24 V	16 A	8 A	12 A	10 A	6 A	10 A	
	DC-13 (inductive) 24 V	2.5 A	2 A	2.5 A	2.5 A	2 A	2 A	
	DC-13 (inductive) 120 V	0.22 A						
	DC-13 (inductive) 250 V	0.1 A						
AC rating (UL 508)	utilization category (pilot duty) (contact rating code designation)	B300		B300		B300		
	max. rated operational voltage	300 V AC		300 V AC		300 V AC		
	max. continuous thermal current at utilization category	5 A		5 A	5 A	2.5 A	5 A	
	max. making / breaking apparent power at utilization category	3600 / 360 VA		3600 / 360 VA		1800 / 180 VA	3600/360 VA	
	utilization category (resistive) (CSA22.2 No.14....)	16 A, 250 V AC	8 A, 250 V AC	10 A, 250 V AC 12 A, 150 V AC	6 A, 250 V AC 10 A, 150 V AC	5 A, 250 V AC 10 A, 150 V AC	10 A, 250 V AC (resistive + single-phase)	
DC rating * (UL 508; NEMA ICS-5)	utilization category (pilot duty) (contact rating code designation)	R300						
	max. rated operational voltage	300 V DC						
	max. continuous thermal current at utilization category	1 A						
	max. making / breaking apparent power at utilization category	28 VA						
	utilization category (resistive) (CSA22.2 No.14....)	-	10 A, 24 V DC	-			10 A, 28 V DC	
	Maximum making (inrush) current	30 A	15 A	24 A	20 A	12 A	20 A	
	Minimum switching power	0.3 W (AgNi), 0.05 W (AgNi/Au)			0.3 W (AgNi), 0.1 W (AgNi/Au)		0.3 W	
	Maximum switching (breaking) power AC1 (resistive)	4000 VA	2000 VA	3000 VA	2500 VA	1500 VA	2500 VA	
	Contact resistance	≤ 100 mΩ						
	Maximum operating frequency rated load AC-1	600 switching cycles/h			1200 switching cycles/h			
	without load	72000 switching cycles/h			18000 switching cycles/h			12000 switching cycles/h
	Mechanical lifetime	> 3 x 10 ⁷ switching cycles			> 2 x 10 ⁷ switching cycles			
	Electrical lifetime electrical AC1 (resistive)	> 0.7 x 10 ⁵ switching cycles (16 A, 250 V)	> 10 ⁵ switching cycles (8 A, 250 V)	> 10 ⁵ switching cycles (12 A, 250 V)	> 10 ⁵ switching cycles (10 A, 250 V)	> 10 ⁵ switching cycles (6 A, 250 V)	> 10 ⁵ switching cycles (12 A, 250 V)	
		cos φ see reduction factor F						
	Response time	typ. 7 ms			typ. 13 ms (DC), 10 ms (AC)		typ. 18 ms (DC), 12 ms (AC)	
	Release time	typ. 3 ms			typ. 3 ms (DC), 8 ms (AC)		typ. 7 ms (DC), 10 ms (AC)	
Isolation data								
	Rated insulation voltage	400 V AC			250 V AC			
	Insulation class	C250 / B400			C250 / B250		C250	
	Rated impulse withstand voltage U _{imp} between coil and contacts	5 kV			2.5 kV			
	between open contacts	1 kV			1.5 kV			
	between c/o (SPDT) contacts	-	2.5 kV	2.5 kV		≥ 2 kV	2 kV	
	Clearance between coil and contacts	≥ 10 mm			≥ 2.5 mm	≥ 1.6 mm	≥ 3 mm	
	Creepage distance between coil and contacts	≥ 10 mm			≥ 4 mm	≥ 3.2 mm	≥ 4.2 mm	
	Overvoltage category	III			III	II	III	
	Pollution degree	3			3	2	3	

* Those ratings are based on different type tests but they are not covered by the cULus or CSA approvals.

Pluggable interface relays and optocouplers

Technical data, load limit curves - CR-P, CR-M, CR-U

Type	CR-P...1	CR-P...2	CR-M...2	CR-M...3	CR-M...4	CR-U...2	CR-U...3
General data							
Dimensions	see 'Dimensional drawings'						
Mounting	on socket (see accessories)						
Mounting position	any						
Degree of protection	IP 67			IP 40			
Electrical connection							
Connection	by socket						
Environmental data							
Ambient temperature range	operation	DC: -40...+85 °; AC: -40...+70 °C			DC: -40...+70 °; AC: -40...+55 °C		
	storage	-40 ... +85 °C					
Vibration resistance 10-150 Hz	n/o contact	10 g			5 g		5 g
	n/c contact	10 g	5 g	5 g	5 g		
Shock resistance	n/o contact	30 g	20 g	10 g	10 g		
	n/c contact	30 g	20 g	5 g	10 g		
Standards/Directives							
Standards	IEC/EN 61810-1						
Low Voltage Directive	-			2014/35/EU			
RoHS Directive	2011/65/EU						

5

Load limit curves - Maximum switching power at resistive DC load

CR-P with 1 c/o contact

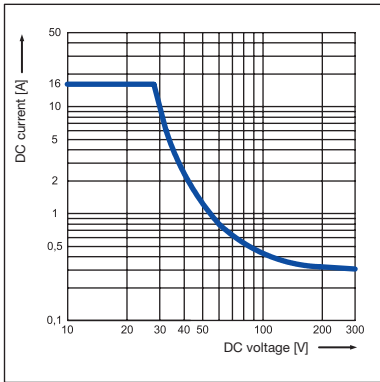

CR-P with 2 c/o contacts

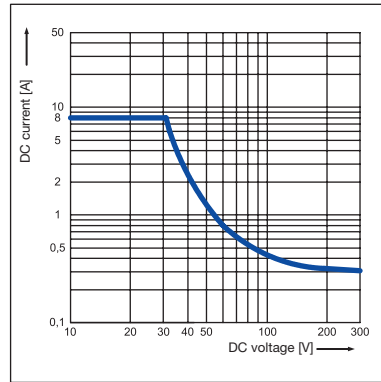

CR-U with 2 and 3 c/o contacts

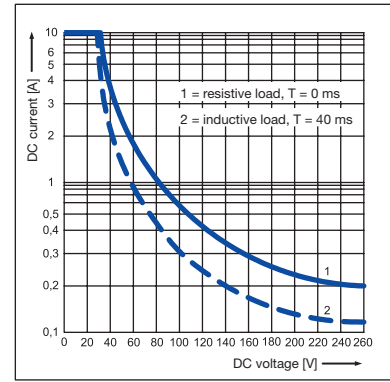

CR-M with 2 c/o contacts

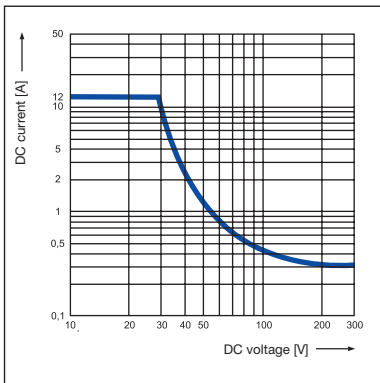

CR-M with 3 c/o contacts

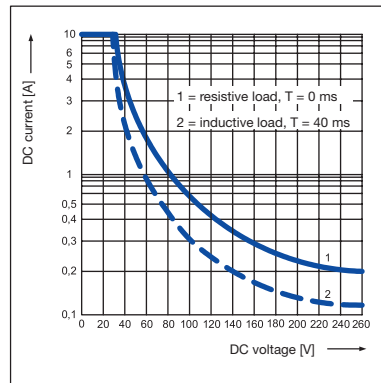

CR-M with 4 c/o contacts

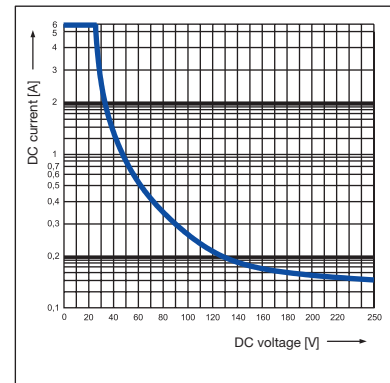

Pluggable interface relays and optocouplers

Technical data - CR-P optocouplers

Input circuits	CR-P024MOS1	CR-P024TRI1
Input resistance	2200 Ω	1950 Ω
Rated control voltage	24 V DC	24 V DC
Pull-in voltage	10 V DC	10 V DC
Maximum input voltage	32 V DC	32 V DC
Nominal input current	10 mA	12 mA
Input power	260 mW	295 mW
Typical switching-on time	50 ms	< 1/2 cycle
Typical switch-off time	250 ms	< 1/2 cycle
Output		
Output circuits	11 (13+) - 14	11 (13+) - 14
Kind of output	MOS-FET	Triac
Rated operational voltage	24 V DC	240 V AC
Maximum switching voltage	35 V DC	275 V AC
Minimum switching current	1 mA	50 mA
Maximum switching current continuously	5 A	3,5 A
Leakage current at maximum switching voltage	10 µA	1 mA
Voltage drop at rated current	300 mV	1,1 V
Isolation data		
Rated insulation voltage	input/output 2,5 kV	2,5 kV
Insulation class	2	2
Clearance	input/output 19 mm	19 mm
Creepage distance	input/output 19 mm	19 mm
Overvoltage category	III	III
Polution degree	2	2
General data		
Dimensions	see 'Dimensional drawings'	
Weight	11 g (0.618 lbs)	11 g (0.618 lbs)
Mounting	on socket	
Enviromental data		
Ambient temperature	operational -20...+80 °C	-20...+80 °C
	storage -40...+100 °C	-40...+100 °C
Standards/ Directives		
Standards	IEC/EN 62314	IEC/EN 62314
EMC Directive	2014/30/EU	2014/30/EU
RoHS Directive	2011/65/EU	2011/65/EU

Derating curves

MOS-FET output

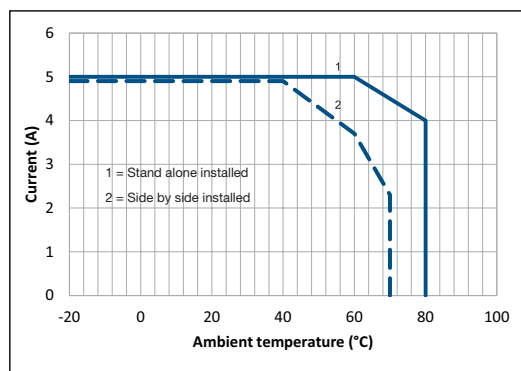

2CDC292 001 F0017

Triac output

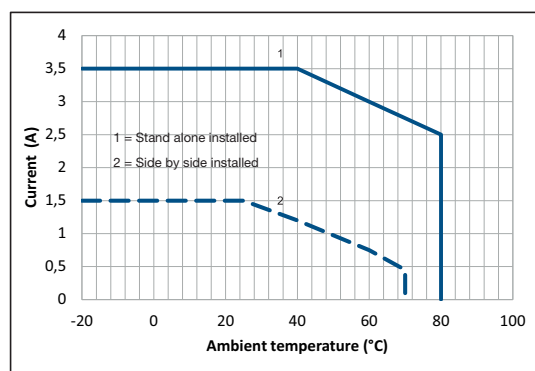

2CDC292 002 F0017

Pluggable interface relays and optocouplers

Technical data - Sockets for CR-P and CR-M

Output circuits		CR-PLS	CR-PLSx	CR-PSS	CR-PLC	CR-MxLS	CR-MxSS	CR-MxSF	CR-MxLC
Output circuits		11-12/14, 21-22/24				11-12/14, 21-22/24, ...			
Number of poles		2				2, 3 or 4		2 or 4	
Rated voltage		250 V AC	300 V AC	250 V AC		250 V AC			300 V AC
Rated current		2 x 10 A ¹⁾	2 x 12 A ¹⁾	2 x 10 A ¹⁾		7 A			10 A
General data									
Dimensions		see 'Dimensional drawings'							
Degree of protection		terminals IP 20 B (EN 60529)							
Temperature range		operation		-40...+70 °C		-40...+85 °C		-40...+70 °C	
		storage		-40...+70 °C		-40...+85 °C		-40...+70 °C	
Connection type		screw connection			spring connection		screw connection		fork type screw
Maximum number of wires per connecting terminal		2			2 (one per connection point)		2		2 (one per connection point)
Connecting capacity		rigid 2 x 0.5 - 2.5 mm ² (2 x 20 - 14 AWG)			2 x 0.2 - 1.5 mm ² (2 x 24 - 16 AWG)		2 x 0.5 - 2.5 mm ² (2 x 20 - 14 AWG)		
		fine-strand							
		with wire end ferrule			2 x 0.5 - 1.5 mm ² (2 x 20 - 16 AWG)		2 x 1.5 mm ² (2 x 16 AWG)		2 x 1.5 mm ² (2 x 16 AWG)
Stripping length		7 mm (0.28 in)			11 mm (0.43 in)		7 mm (0.28 in)		10 mm (0.39 in)
Tightening torque		0.6 Nm		0.8 Nm		0.6 Nm		0.6 Nm (5.31 lb.in)	
Maximum clamping force		with 0.2 mm ²		-		-		10 N	
		with 1.5 mm ²		-		-		40 N	
		with wire end ferrule		-		-		> 40 N	
Mounting		DIN rail (IEC/EN 60715)							
Material		socket PA 6+GF - V2				PA 6+GF - V2			
		contacts CuZn33				CuZn33			
		contact surface		5 μ Ni		5 μ tinned		5 μ Ni	
		terminals		8 μ Ni		8 μ galvanized		8 μ Ni	
		combi screw M3		8.8 Steel, 5 μ Ni		-		8.8 Steel, 5 μ Ni	
Isolation data									
Insulation voltage		> 5 kV		> 3 kV		> 5 kV		> 3 kV	
Isolation between coil and contacts		IEC/EN 61984							
Clearance and creepage distance		IEC/EN 61984							
Standards/Directives									
Standards		IEC/EN 61984							
Low Voltage Directive		2014/35/EU							
RoHS Directive		2011/65/EU							

¹⁾ Loads >10 A (>12 A for CR-PLSx) require jumpering of terminal 11 with 21, 12 with 22, and 14 with 24

Pluggable interface relays and optocouplers

Technical data - Sockets for CR-U

Output circuits		CR-U2S	CR-U3S	CR-U3E	CR-UxSM
Output circuits		11-12/14, 21-22/24,...			
Number of poles		2	3		2 or 3
Rated voltage		250 V AC		300 V AC	250 V
Rated current		10 A			
General data					
Dimensions		see 'Dimensional drawings'			
Degree of protection	terminals	IP 20 B (EN 60529)			
Temperature range	operation	-40...+70 °C		-40...+85 °C	-40...+70 °C
	storage	-40...+70 °C		-40...+85 °C	-40...+70 °C
Connecting capacity	rigid	2 x 2 x 0,5 - 2,5 mm ² (2 x 20 - 14 AWG)			
	fine-strand				
	with wire end ferrule	2 x 0,5 - 1,5 mm ² (2 x 20 - 16 AWG)		2 x 0,5 - 1,5 mm ² (2 x 20 - 16 AWG)	2 x 0,5 - 1,5 mm ² (2 x 20 - 16 AWG)
Stripping length		7 mm (0,28 in)			
Tightening torque		0,6 Nm		0,8 Nm	0,6 Nm
Mounting		DIN rail (IEC/EN 60715)			
Material	socket	PA 6+GF - V2			
	contacts	CuZn33			
	contact surface	6 μ Ni			
	terminals	8 μ Ni			
	combi screw M3	8,8 steel, 5μ Ni		8 μ galvanized	3 μ Ni 10 μ Ni Steel, 8 μ Ni
Isolation data					
Insulation voltage		> 2 kV			
Isolation between coil and contacts		IEC/EN 61984			
Clearance and creepage distance		IEC/EN 61984			
Standards/Directives					
Standards		IEC/EN 61984			
Low Voltage Directive		2014/35/EU			
RoHS Directive		2011/65/EU			

Pluggable interface relays and optocouplers

Load limit curves - CR-P, CR-M and CR-U

Load limit curves - Electrical lifetime at resistive AC load

CR-P with 1 c/o contact

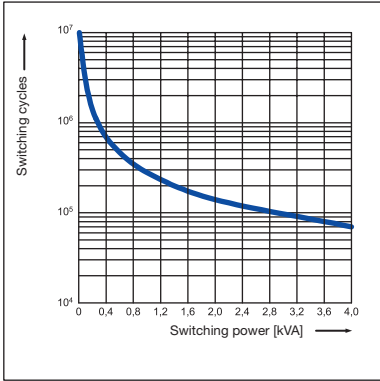

CR-P with 2 c/o contacts

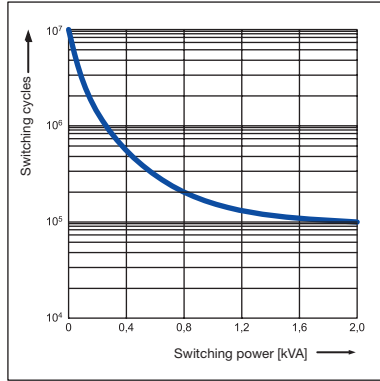

CR-U with 2 and 3 c/o contacts

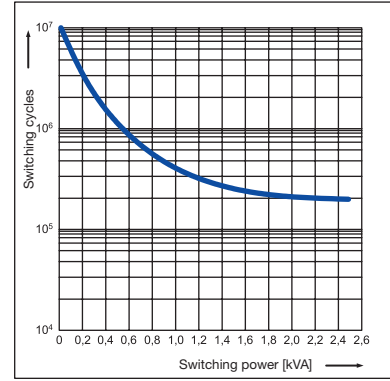

5

CR-M with 2 c/o contacts

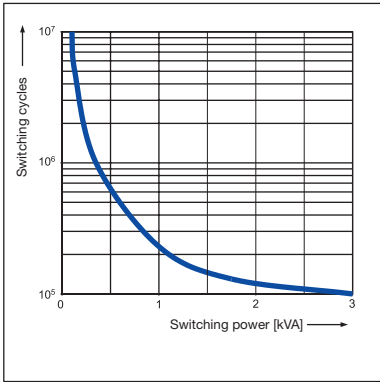

CR-M with 3 c/o contacts

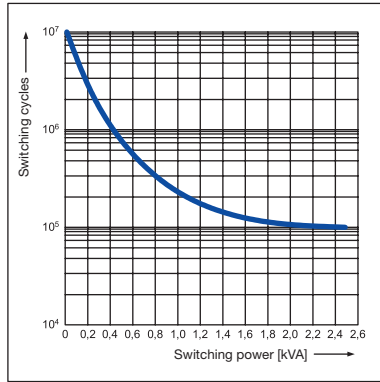

CR-M with 4 c/o contacts

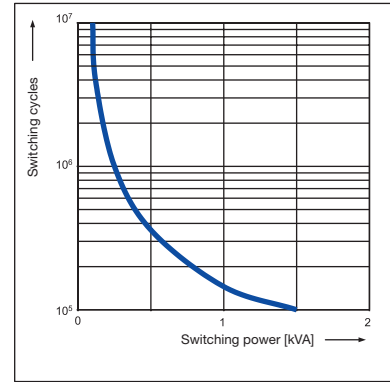

Reduction factor F at inductive AC load

CR-P

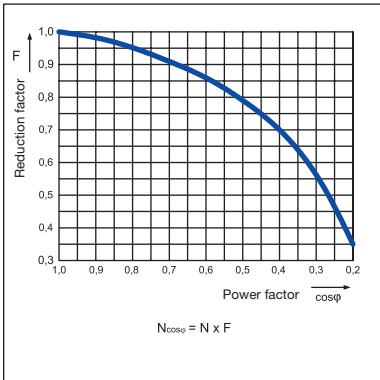

CR-M

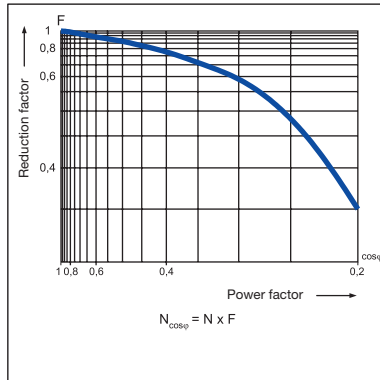

CR-U

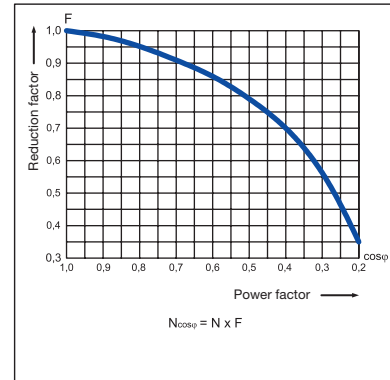

Pluggable interface relays and optocouplers

Technical data - CR-S interface relays

	Rated control supply voltage U_s	Make voltage (at 23 °C)	Maxium voltage (at 55 °C)	Break voltage	Rated power	Coil resistance (at 23 °C)	Tolerance of coil resistance
CR-S005VDC1R(G)	5 V DC	3.75 V DC	7.5 V DC	0.25 V DC	170 mW	147 Ω	± 10 %
CR-S012VDC1R(G)	12 V DC	9 V DC	18 V DC	0.6 V DC	170 mW	848 Ω	± 10 %
CR-S024VDC1R(G)	24 V DC	18 V DC	36 V DC	1.2 V DC	170 mW	3390 Ω	± 15 %
CR-S048VDC1R(G)	48 V DC	36 V DC	72 V DC	2.4 V DC	210 mW	10600 Ω	± 15 %
CR-S060VDC1R(G)	60 V DC	45 V DC	90 V DC	3 V DC	210 mW	16600 Ω	± 15 %

Output circuits

Output circuits	11-12/14		
Kind of output	1 c/o (SPDT)		
Contact material	AgSnO ₂ / AgSnO ₂ /Au		
Rated operational voltage U_o (IEC/EN 60947-1)	250 V AC		
Minimum switching voltage	12 V DC		
Maximum switching voltage	400 V AC / 125 V DC		
Minimum switching current	100 mA (AgSnO ₂) / 10 mA (AgSnO ₂ /Au)		
Rated free air thermal current I_{th}	5 A		
Rated operational current (IEC/EN 60947-5-1)	AC12 (resistive)	230 V	6 A
	AC15 (inductive)	230 V	1.5 A
	AC15 (inductive)	120 V	3 A
	DC12 (resistive)	24 V	6 A
	DC13 (inductive)	24 V	1 A
	DC13 (inductive)	120 V	0.22 A
	DC13 (inductive)	250 V	0.11 A
AC rating (UL 508; NEMA ICS-5)	utilization category (pilot duty)	B300	
	(contact rating code designation)		
DC rating (UL 508; NEMA ICS-5)	utilization category (pilot duty)	R300	
	(contact rating code designation)		
Maximum making (inrush) current	15 A, 240 V AC		
Minimum switching power	100 mA/12 V (AgSnO ₂) / 50 mW (AgSnO ₂ /Au)		
Maximum switching (breaking) power	AC1 (resistive)	1500 VA, 250 V AC	
Contact resistance	100 mΩ (at 1 A/ 6 V DC)		
Maximum operating frequency	rated load AC1	360 switching cycles/h	
	without load	18000 switching cycles/h	
Mechanical lifetime	1 x 10 ⁷ switching cycles		
Electrical lifetime	AC1 (resistive)	(n/c) 3 x 10 ⁴ switching cycles (at +85 °C)	
		(n/o) 1 x 10 ⁴ switching cycles (at +85 °C)	
Response time	8 ms		
Release time	4 ms		
Isolation data			
Rated insulation voltage	250 V AC		
Rated impulse withstand voltage U_{imp}	between coil and contacts	4000 V 1 min	
	between open contacts	1000 V 1 min	
Clearance	between coil and contacts	5.5 mm (0.217 in)	
Creepage distance	between coil and contacts	8 mm (0.315 in)	
Overvoltage category	III		
Pollution degree	2		
General data			
Dimensions	see 'Dimensional drawings'		
Mounting	on socket		
Mounting position	any		
Degree of protection	RT II and RT III		
Electrical connection			
Connection	by socket		
Environmental data			
Ambient temperature range	operation	-40...+85 °C	
	storage	-40...+85 °C	
Vibration resistance (10-150 Hz)	n/o contact	10 Hz to 55 Hz 1mm DA	
	n/c contact	10 Hz to 55 Hz 1mm DA	
Shock resistance	n/o contact	functional 49 m/s ² / destructive 980 m/s ²	
	n/c contact	functional 49 m/s ² / destructive 980 m/s ²	
Standards/Directives			
Standards	IEC/EN 61810-1		
RoHS Directive	2011/65/EU		

Pluggable interface relays and optocouplers

Technical data - CR-S optocouplers

Input circuits	CR-S024VDC1TRA	CR-S024VDC1MOS	CR-S024VDC1TRI
Input resistance	3400 Ohm		
Rated control voltage	24 V DC*		
Pull-in voltage	15 V DC		
Maximum input voltage	30 V DC		
Nominal input current	7 mA		
Input power	168 mW		
Typical switching-on time	< 40 ms	< 60 ms	< 1/2 cycle
Typical switch-off time	< 600 ms	< 600 ms	< 1/2 cycle
Output			
Output circuits	11 (13+) - 14	11 (13+) - 14	11 (13+) - 14
Kind of output	Transistor	MOS-FET	Triac
Rated operational voltage	48 V DC	24 V DC	240 V AC
Maximum switching voltage	48 V DC	24 V DC	275 V AC
Minimum switching current	50 mA	50 mA	22 mA
Maximum switching current continuously	100 mA	2 A	2 A
Leakage current at maximum switching voltage	<1 mA	<1 mA	< 1.5 mA
Voltage drop at rated current	< 120 mV DC	< 120 mV DC	< 1.6 V AC
Isolation data			
Rated insulation voltage	input/output	2,5 kV	
Insulation class		2	
Clearance	input/output	14 mm	
Creepage distance	input/output	14 mm	
Overtoltage category		III	
Polution degree		2	
General data			
Dimensions		see 'Dimensional drawings'	
Weight		3.5 g (0.007 lb)	
Mounting		on socket	
Enviromental data			
Ambient temperature	operation	-30...+80 °C	
	storage	-40...+100 °C	
Standards/ Directives			
Standards		IEC/EN 62314	
EMC Directive		2014/30/EN	
RoHS Directive		2011/65/EN	

* The output circuit should not exceed 30 m

Technical diagrams CR-S interface reays

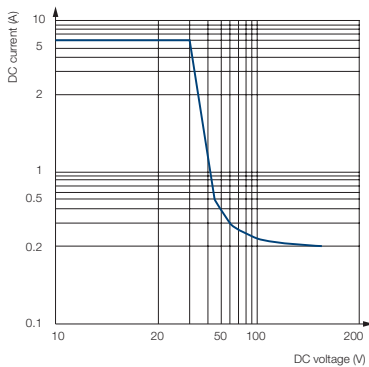

2CDC 292 012 F02 14

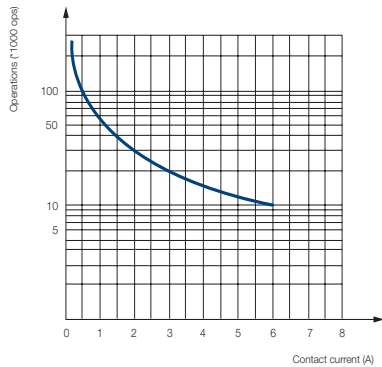

2CDC 292 013 F02 14

Max. DC load breaking capacity

Endurance curve

Technical diagrams - CR-S optocouplers

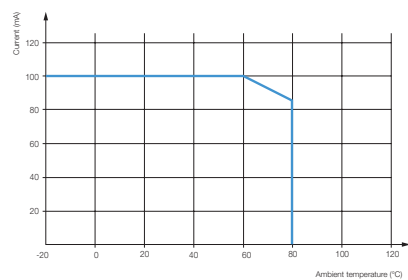

2CDC 292 005 F00 16

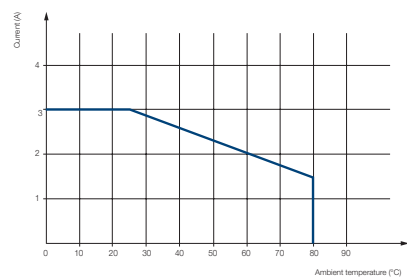

2CDC 292 006 F00 16

Derating curve Transistor output

Derating curve MOS-FET output

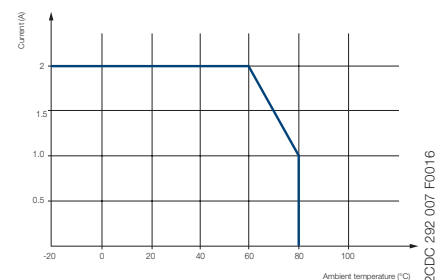

2CDC 292 007 F00 16

Derating curve Triac output

Pluggable interface relays and optocouplers

Technical data - CR-S sockets

Input circuits	CR-S 6-24 V	CR-S 12-24 V	CR-S 48-60 V	CR-S 110-125 V	CR-S 220-240 V
Rated control supply voltage U_s	6-24 V DC	12-24 V AC/DC*	48-60 V AC/DC	110-125 V AC/DC	220-240 V AC/DC
Rated control supply voltage U_s tolerance	(0.8-1.2) U_n	(0.8-1.1) U_n			
Typical current	11-29 mA	11-16 mA	3.6-4.5 mA	3.6 mA	3.6 mA
Response time	8 ms				
Release time	4 ms				
Status device	green LED				
Protective circuit	yes				
Output circuits					
Output circuits	11-12/14				
Number of poles	1				
Rated voltage	250 V AC				
Rated current	6 A				
General data for CR-S with screw connection terminal					
Dimensions	see 'Dimensional drawings'				
Degree of protection (EN 60529)	Degree of protection (EN 60529) IP20 (terminals)				
Temperature range	operation	-40...+70 °C			-40...+55 °C
	storage	-40...+85 °C			
Connection type	Screw				
Maximum number of wires per connection terminal	2				
Connecting capacity	rigid	2 x 0.5 - 1.5 mm ² (2 x 20 - 16 AWG)			
	fine-strand				
	with wire end ferrule	2 x 0.5 - 1 mm ² (2 x 20 - 18 AWG)			
Tightening torque	0.5 Nm (4.426 lb.in)				
Stripping length	7 mm (0.28 in)				
Mounting (IEC/EN 60715)	DIN rail				
Material	socket	PA6 +GF-V2			
	contacts	CuZn36			
	contact surface	3 μ Ni/Sn			
	terminals	CuZn40, 3 μ Ni			
	combi screw M3	Fe			
General data for CR-S with spring connection terminal					
Dimensions without holder (L x W x H)	see 'Dimensional drawings'				
Degree of protection (EN 60529)	Degree of protection (EN 60529) IP20 (terminals)				
Temperature range	operation	-40...+70 °C			-40...+55 °C
	storage	-40...+85 °C			
Connection type	Spring				
Maximum number of wires per connection terminal	1				
Connecting capacity	0.75 - 2.5 mm ² (20 - 14 AWG) rigid, fine-strand and with wire end ferrule				
Stripping length	7 mm (0.28 in)				
Mounting (IEC/EN 60715)	DIN rail				
Material	socket	PA6 +GF-V2			
	contacts	CuZn36			
	contact surface	3 μ Ni/Sn			
	spring terminals	SUS301			
Isolation data					
Isolation between coil and contacts	5000 V AC				
Resistance to shock coil to contact	1000 MΩ				
Clearance and creepage distance	IEC/EN 61984				
Standards/Directives					
Standard	IEC/EN 61984				
Low Voltage Directive	2014/35/EU				
RoHS Directive	2011/65/EU				

* In combination with optocouplers, only DC supply is allowed

Pluggable interface relays and optocouplers

Connection diagrams

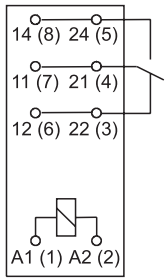

2CDC 292 001 F0004

CR-P with 1 c/o contact

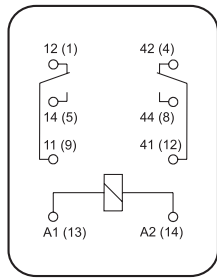

2CDC 292 011 F0004

CR-M with 2 c/o contacts

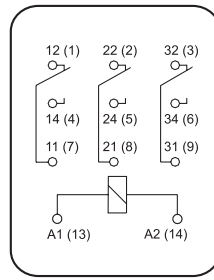

2CDC 292 016 F0004

CR-M with 3 c/o contacts

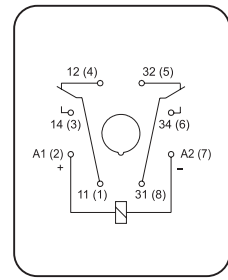

2CDC 292 024 F0004

CR-U with 2 c/o contacts

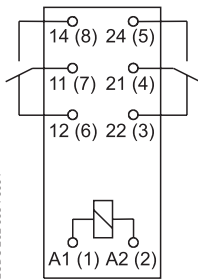

2CDC 292 008 F0004

CR-P with 2 c/o contacts

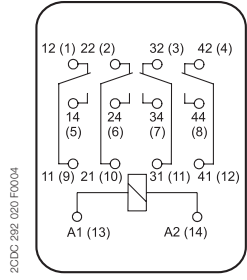

2CDC 292 020 F0004

CR-M with 4 c/o contacts

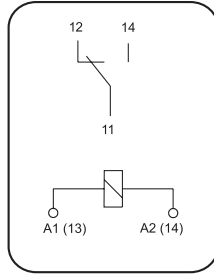

2CDC 292 001 F0014

CR-S

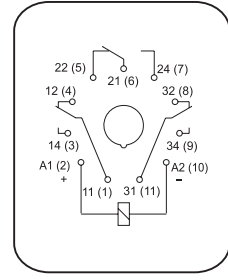

2CDC 292 030 F0004

CR-U with 3 c/o contacts

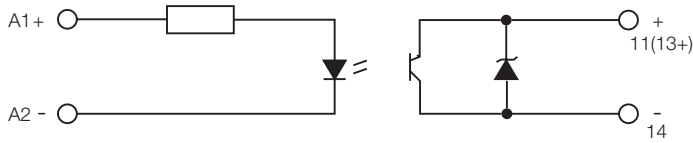

2CDC 292 001 F0016

CR-S optocoupler with Transistor

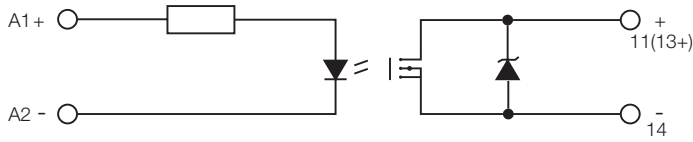

2CDC 292 002 F0016

CR-S optocoupler with MOSFET

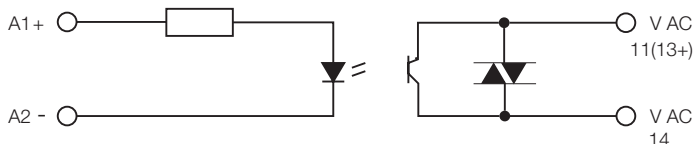

2CDC 292 001 F0016

CR-S optocoupler with Triac

Pluggable interface relays and optocouplers

Dimensional drawings

Dimensions in mm and inches

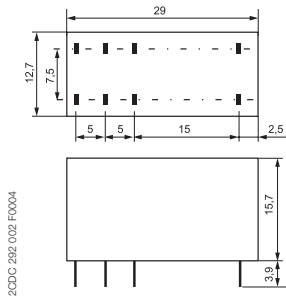

CR-P relay

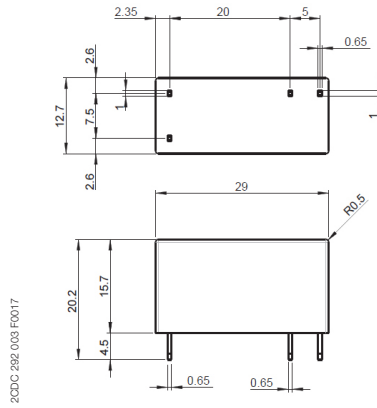

CR-P optocoupler

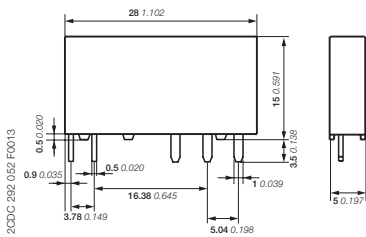

CR-S relay

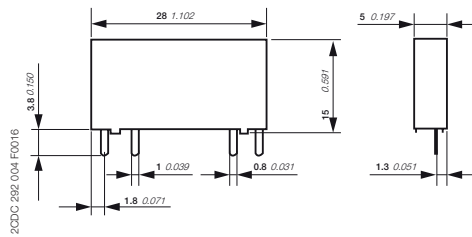

CR-S optocoupler

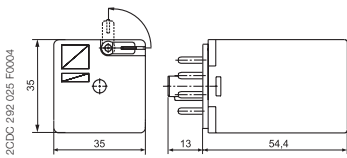

CR-U with 2 c/o contacts

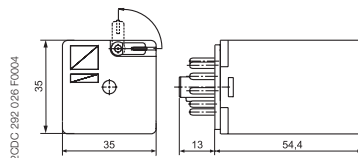

CR-U with 3 c/o contacts

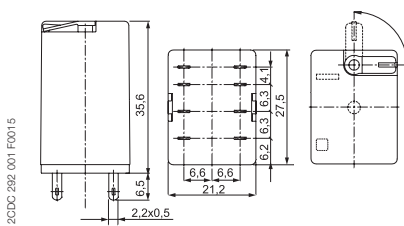

CR-M with 2 c/o contacts

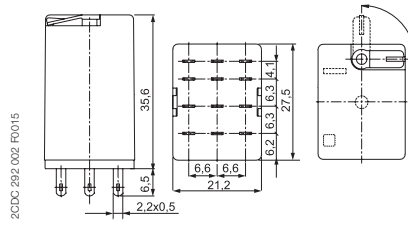

CR-M with 3 c/o contacts

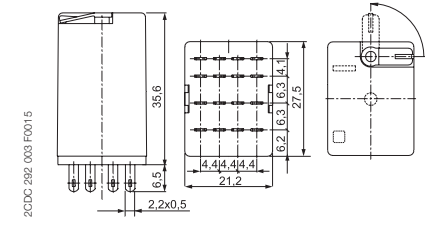

CR-M with 4 c/o contacts

Pluggable interface relays and optocouplers

Dimensional drawings

Dimensions in mm and inches

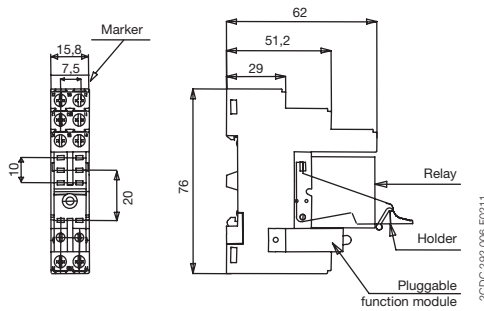

CR-PLS - screw connection

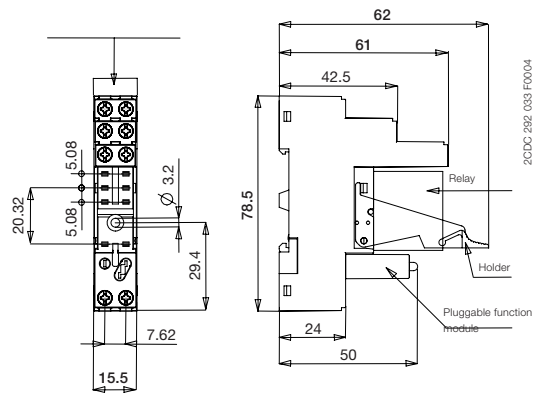

CR-PLSx - screw connection

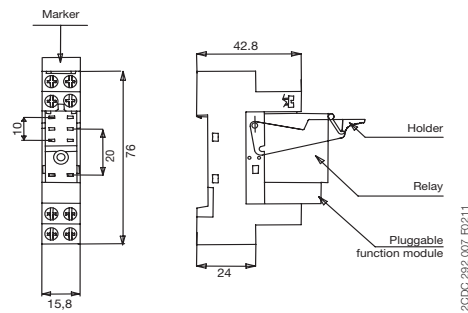

CR-PSS - screw connection

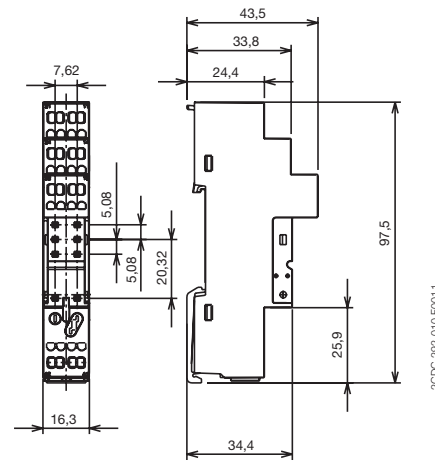

CR-PLC - spring connection

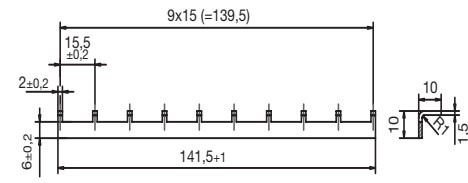

CR-PJ

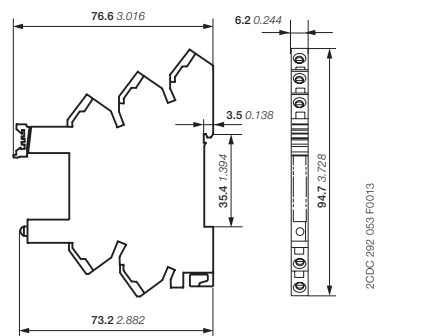

Spring socket for CR-S range interface relays

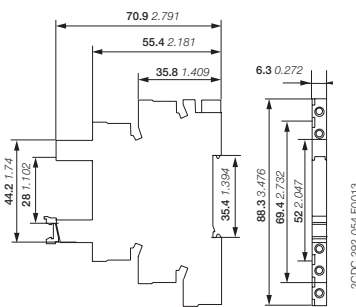

Screw socket for CR-S range interface relays

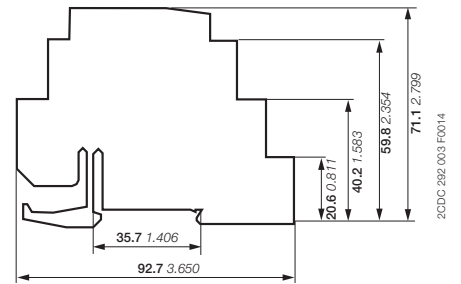

Separator for CR-S

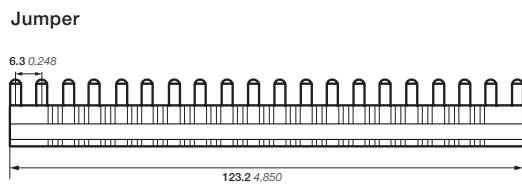

Jumper bar CR-S

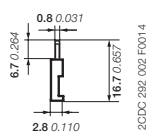

Pluggable interface relays and optocouplers

Dimensional drawings

Dimensions in mm and inches

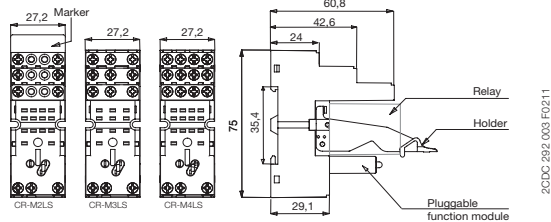

2CDC 282 003 F0211

CR-M2LS - CR-M3LS - CR-M4LS - screw connection

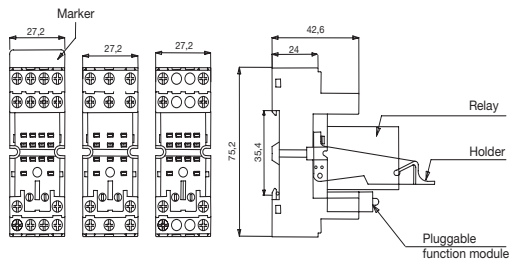

2CDC 282 004 F0211

CR-M2SS - CR-M3SS - CR-M4SS - screw connection

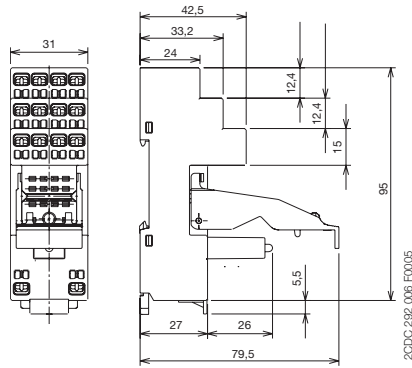

2CDC 282 006 F0005

CR-M2LC, CR-M4LC - spring connection

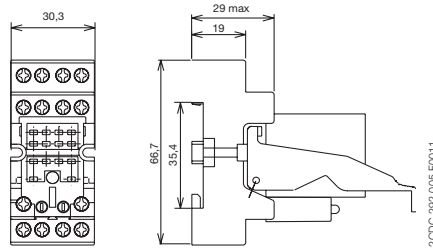

2CDC 282 005 F0011

CR-MxSF - screw connection

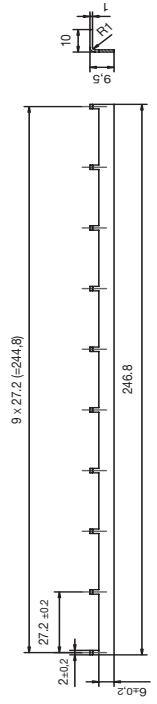

CR-MJ

2CDC 282 011 F0011

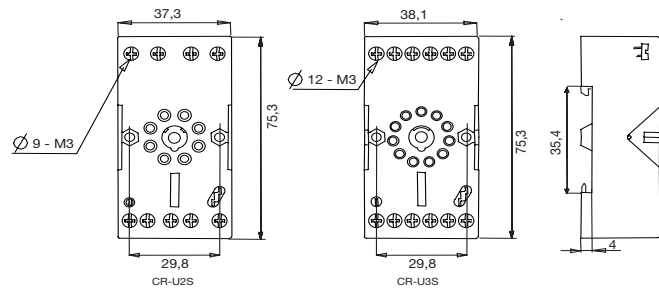

2CDC 282 008 F0011

CR-U2S - CR-U3S

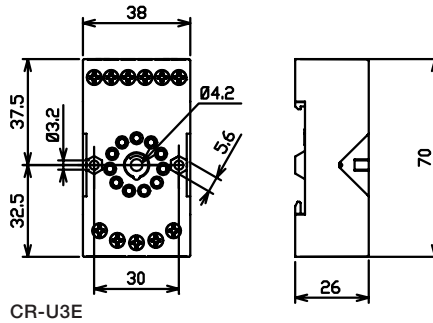

2CDC 282 081 F0004

CR-U3E

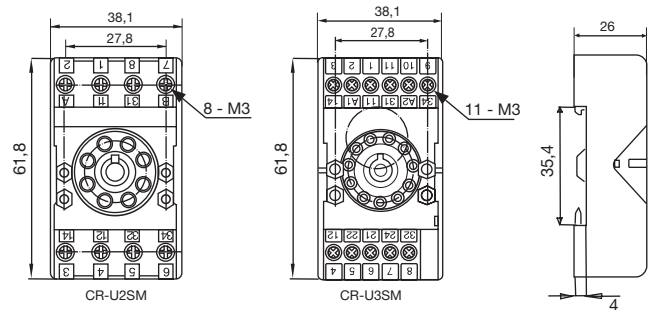

2CDC 282 009 F0011

CR-UxSM

Boxed interface relays and optocouplers R600 range

Product group picture

5

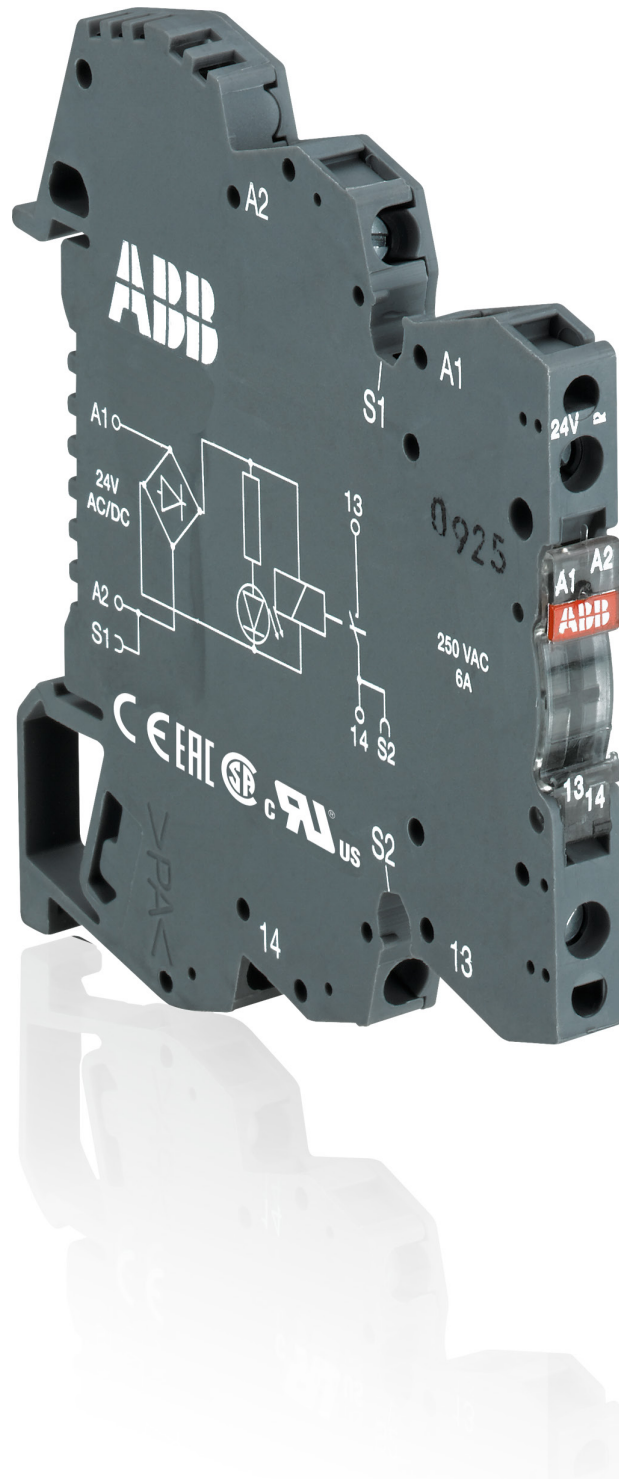

Boxed interface relays and optocouplers R600 range

Table of contents

Boxed interface relays and optocouplers R600 range

Overview	5/33
Benefits and advantages	5/34
Boxed interface relays R600 range	5/35
Selection	5/35
Ordering details	5/37
Connection diagrams	5/39
Technical data	5/40
Dimensional drawings, Load limit curves	5/43
Boxed interface optocouplers R600 range	5/45
Selection	5/45
Ordering details	5/46
Connection diagrams	5/47
Technical data	5/49
Technical data, Dimensions	5/50

Boxed interface relays and optocouplers R600 range

Overview

ABB's R600 range of boxed interface relays and optocouplers is used for electrical isolation, amplification and signal matching between the control unit and the sensor/actuator level. The space saving design and different connection terminal possibilities optimize your panel installation.

The broad portfolio of R600 range offers the most suitable interface solution for your application.

5

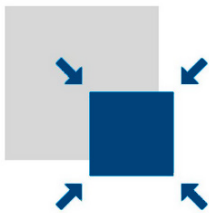

Space saving

Thanks to the 6 mm slim and 70 mm short housing, you maximize the foot print of your panel. The 75 mm depth allows you the use in a compact cabinet.

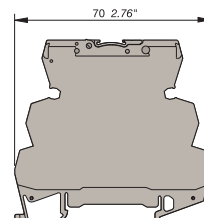

Screw clamp module

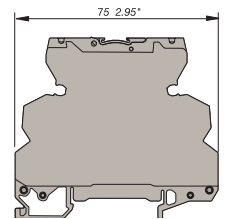

Spring clamp module



Easy to install

The R600 interface relays and optocouplers are easy to mount by snapping onto a DIN-rail according to IEC/EN 60715.

Time saving wiring thanks to a jumper bar.

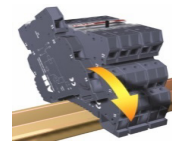

Global availability

Applicable all over the world according to the highest standards. You will find R600 boxed interface relays and optocouplers in any application and every corner of the world.

Boxed interface relays and optocouplers R600 range

Benefits and advantages

Marine certification

R600 range offers the LR approval, which allows usage of the boxed interface relays and optocouplers in many applications around the marine segment. The performance of the R600 range has proven by successfully passing tests required harshest conditions.

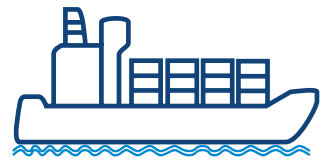

5

Complete product line

1 n/o, 1 n/c, 1 c/o, 2 c/o output configuration. Standard contact material for switching high current signals as well as gold-plated contacts for reliable switching of low current signals.

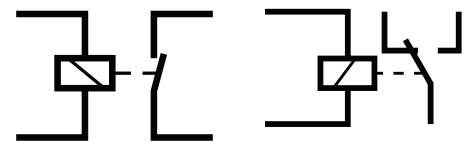

1 NO

1 SPDT

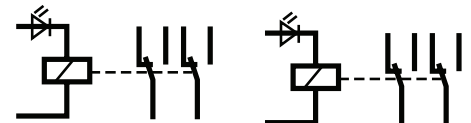

1 DPDT

1 NC

Optocoupler with Transistor, MOS-FET and Triac output for longer lifetime, higher reliability and quiet operation.
Screw and spring connection terminals.

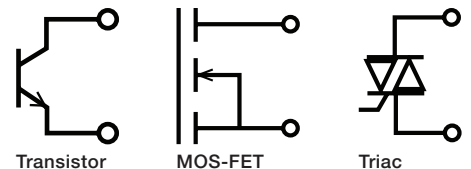

Transistor

MOS-FET

Triac

Safe operation

High resistance to vibration and shock thanks to the relay soldered inside of the housing.

Wrong relay replacement or relay lose not possible .

Devices with immunity to leakage currents.

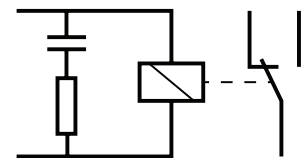

Leakage current protection

Clear functioning status

Green LED for status indication of the control supply voltage.



Boxed interface relays R600 range

Selection

5

Type	Order number																			
RB121P-5VDC	1SNA645034R2300																			
RB121PG-5VDC	1SNA645036R2500																			
RBR121P-5VDC	1SNA645534R2500																			
RB121-12VDC	1SNA645073R0000																			
RB121P-12VDC	1SNA645035R2400																			
RB121G-12VDC	1SNA645075R0000																			
RBR121P-12VDC	1SNA645535R2600																			
RB101R-24VUC	1SNA645019R0400																			
RBR101R-24VUC	1SNA645519R0600																			
RB111-24VUC	1SNA645014R2700																			
RB111R-24VUC	1SNA645018R0300																			
RBR111R-24VUC	1SNA645518R0500																			
RBR111-24VUC	1SNA645514R2100																			
RB121-24VUC	1SNA645001R0300																			
RB121G-24VUC	1SNA645005R0700																			
RBR121-24VUC	1SNA645501R0500																			
RBR121G-24VUC	1SNA645505R0100																			
RB122G-24VUC	1SNA645012R2500																			
RBR122G-24VUC	1SNA645512R2700																			
RB121-24VDC	1SNA645071R0000																			
RBR121-24VDC	1SNA645571R0000																			
RB121G-24VDC	1SNA645072R0000																			
RBR121G-24VDC	1SNA645572R0000																			
RB121-48-60VUC	1SNA645002R0400																			
RB121G-48-60VUC	1SNA645006R0000																			
RBR121-48-60VUC	1SNA645502R0600																			
RBR121G-48-60VUC	1SNA645506R0200																			

Input voltage																				
5 V DC	■	■	■																	
12 V DC				■	■	■	■													
24 V DC								■	■	■	■	■	■	■	■	■	■	■	■	■
48-60 V DC																			■	■
115 V DC																				
230 V DC																				
60-230 V DC																				
24 V AC								■	■	■	■	■	■	■	■	■	■	■	■	■
48-60 V AC																			■	■
115 V AC																				
230 V AC																				
60-230 V AC																				

Output rating																				
10 mA - 6 A	■		■	■	■		■	■	■	■	■	■	■	■	■	■	■	■	■	■
3 mA - 6 A		■				■													■	■
1 mA - 8 A																				

Output contacts																				
c/o	1	1	1	1	1	1	1							1	1	1	1	2	2	1
n/o										1	1	1	1							
n/c								1	1											

Terminal type																				
Screw	■	■		■	■	■		■		■	■			■	■		■		■	■
Spring			■				■		■		■	■		■	■		■		■	■

Boxed interface relays R600 range

Ordering details



R600 - 6 mm

2CDC 281 024 50013



R600 - 12 mm

2CDC 281 013 50013

1 n/c contact: 250 V, 10 mA - 6 A, width 12 mm

Rated control supply voltage	Connection type	Particularities	Type	Order code	Pkg qty	Weight (1 pc) kg (lb)
24 V AC/DC	Screw	RC circuit parallel to output contact	RB101R-24VUC	1SNA645019R0400	5	0.04 (0.088)
	Spring		RBR101R-24VUC	1SNA645519R0600		

1 n/o contact: 250 V, 10 mA - 6 A, width 6 mm

Rated control supply voltage	Connection type	Particularities	Type	Order code	Pkg qty	Weight (1 pc) kg (lb)
24 V AC/DC	Screw		RB111-24VUC	1SNA645014R2700	10	0.02 (0.044)
115 V AC/DC	Screw		RB111-115VUC	1SNA645016R2100		
230 V AC/DC	Screw		RB111-230VUC	1SNA645017R2200		
24 V AC/DC	Spring		RBR111-24VUC	1SNA645514R2100		

1 n/o contact: 250 V, 10 mA - 6 A, width 12 mm

Rated control supply voltage	Connection type	Particularities	Type	Order code	Pkg qty	Weight (1 pc) kg (lb)
24 V AC/DC	Screw	RC circuit parallel to output contact	RB111R-24VUC	1SNA645018R0300	5	0.04 (0.088)
	Spring		RBR111R-24VUC	1SNA645518R0500		

1 c/o (SPDT) contact: 250 V, 10 mA - 6 A, width 6 mm

Rated control supply voltage	Connection type	Particularities	Type	Order code	Pkg qty	Weight (1 pc) kg (lb)
5 V DC	Screw	A1-A2 polarized	RB121P-5VDC	1SNA645034R2300	10	0.02 (0.044)
12 V DC	Screw	A1-A2 polarized	RB121P-12VDC	1SNA645035R2400		
12 V DC	Screw		RB121-12VDC	1SNA645073R0000		
24 V DC	Screw		RB121-24VDC	1SNA645071R0000		
24 V AC/DC	Screw		RB121-24VUC	1SNA645001R0300		
48-60 V AC/DC	Screw		RB121-48-60VUC	1SNA645002R0400		
115 V AC/DC	Screw		RB121-115VUC	1SNA645003R0500		
230 V AC/DC	Screw		RB121-230VUC	1SNA645004R0400		
5 V DC	Spring	A1-A2 polarized	RBR121P-5VDC	1SNA645534R2500		
12 V DC	Spring	A1-A2 polarized	RBR121P-12VDC	1SNA645535R2600		
24 V DC	Spring		RBR121-24VDC	1SNA645571R0000		
24 V AC/DC	Spring		RBR121-24VUC	1SNA645501R0500		
48-60 V AC/DC	Spring		RBR121-48-60VUC	1SNA645502R0600		
115 V AC/DC	Spring		RBR121-115VUC	1SNA645503R0700		
230 V AC/DC	Spring		RBR121-230VUC	1SNA645504R0000		

1 c/o (SPDT) contact: 250 V, 3 mA - 6 A, gold-plated contacts, width 6 mm

Rated control supply voltage	Connection type	Particularities	Type	Order code	Pkg qty	Weight (1 pc) kg (lb)
5 V DC	Screw	A1-A2 polarized	RB121PG-5VDC	1SNA645036R2500	10	0.02 (0.044)
12 V DC	Screw		RB121G-12VDC	1SNA645075R0000		
24 V DC	Screw		RB121G-24VDC	1SNA645072R0000		
24 V AC/DC	Screw		RB121G-24VUC	1SNA645005R0700		
48-60 V AC/DC	Screw		RB121G-48-60VUC	1SNA645006R0000		
115 V AC/DC	Screw		RB121G-115VUC	1SNA645007R0100		
230 V AC/DC	Screw		RB121G-230VUC	1SNA645008R1200		
24 V DC	Spring		RBR121G-24VDC	1SNA645572R0000		
24 V AC/DC	Spring		RBR121G-24VUC	1SNA645505R0100		
48-60 V AC/DC	Spring		RBR121G-48-60VUC	1SNA645506R0200		
115 V AC/DC	Spring		RBR121G-115VUC	1SNA645507R0300		
230 V AC/DC	Spring		RBR121G-230VUC	1SNA645508R1400		



Further documentation
R600 range on www.abb.com

Boxed interface relays R600 range

Ordering details

1 c/o (SPDT) contact: 250 V, 10 mA - 6 A, width 12 mm

Rated control supply voltage	Connection type	Particularities	Type	Order code	Pkg qty	Weight (1 pc) kg (lb)
60-230 V AC/DC	Screw		RB121-60-230VUC	1SNA645020R0100	5	0.04 (0.088)
115 V AC/DC	Screw	Leakage current protection, RC circuit parallel to input	RB121R-115VUC	1SNA645046R0700		
230 V AC/DC	Screw		RB121R-230VUC	1SNA645011R2400		
60-230 V AC/DC	Spring		RBR121-60-230VUC	1SNA645520R0300		
230 V AC/DC	Spring	Leakage current protection, RC circuit parallel to input	RBR121R-230VUC	1SNA645511R2600		

2 c/o (SPDT) contacts: 250 V, 1 mA - 8 A, gold-plated contacts, width 12 mm

Rated control supply voltage	Connection type	Type	Order code	Pkg qty	Weight (1 pc) kg (lb)
24 V AC/DC	Screw	RB122G-24VUC	1SNA645012R2500	5	0.04 (0.088)
48-60 V AC/DC	Screw	RB122G-48-60VUC	1SNA645040R1500		
115 V AC/DC	Screw	RB122G-115VUC	1SNA645041R0200		
230 V AC/DC	Screw	RB122G-230VUC	1SNA645013R2600		
24 V AC/DC	Spring	RBR122G-24VUC	1SNA645512R2700		
48-60 V AC/DC	Spring	RBR122G-48-60VUC	1SNA645540R1700		
115 V AC/DC	Spring	RBR122G-115VUC	1SNA645541R0400		
230 V AC/DC	Spring	RBR122G-230VUC	1SNA645513R2000		

Ordering details - Accessories

Description	Type	Order code	Pkg qty	Weight (1 pc) kg (lb)
Jumper bar, 10 poles * (replacement of BJ612-10 - 1SNA290488R0100)	RB-JB10	1SVR406570R0000	10	0.05 (0.11)
Jumper bar, 20 poles * (replacement of BJ612-20 - 1SNA206754R0000)	RB-JB20	1SVR406580R0000		0.10 (0.22)
Separator end section	SC612	1SNA290474R0200		0.05 (0.11)
Front marking blank cards, 100 pcs.	RC610	1SNA233000R0100		
Terminal marking blank cards, 100 pcs.	RC65	1SNA232000R0000		

- * - Before the first and after the last jumpered R600 relay, a separator end section shall be used.
 - The sum of the current for jumpered devices shall not exceed 6 A on 6 mm devices and 8 A on 12 mm devices.

5

Boxed interface relays R600 range

Connection diagrams

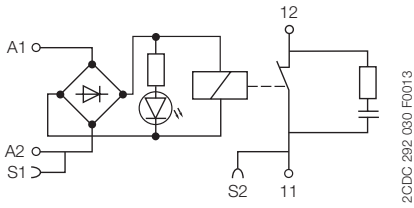

RB(R)101R - 24VUC

2CDC 292 030 F0013

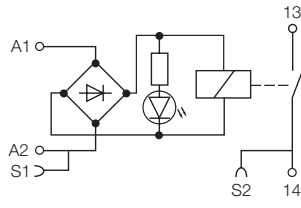

RB(R)111-24VUC

2CDC 292 031 F0013

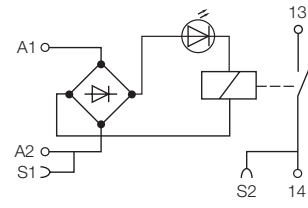

RB111-115VUC/230VUC

2CDC 292 033 F0013

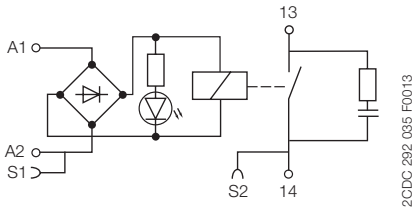

RB(R)111R-24VUC

2CDC 292 035 F0013

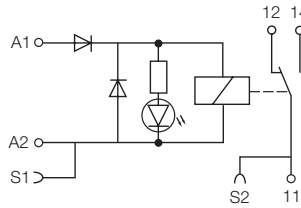

RB(R)121P(G)-5VDC/12VDC

2CDC 292 036 F0013

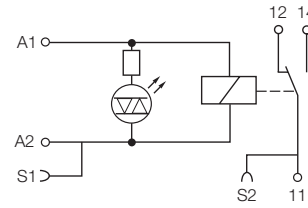

RB(R)121-12VDC/24VDC

2CDC 292 038 F0013

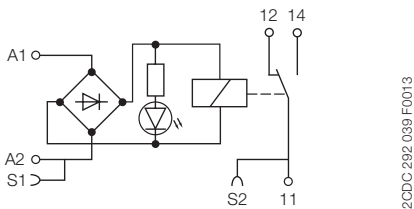

RB(R)121(G)-24VUC

2CDC 292 039 F0013

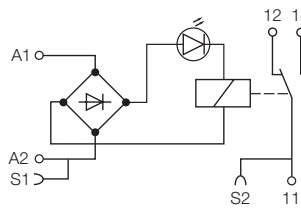

**RB(R)121(G)-48-60VUC/
115VUC/230VUC/60-230VUC**

2CDC 292 040 F0013

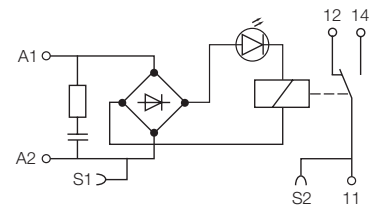

RB(R)121R-115VUC/230VUC

2CDC 292 042 F0013

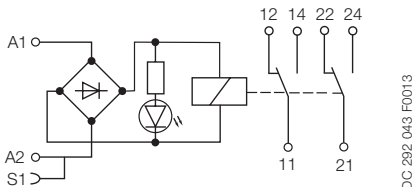

RB(R)122G-24VUC/48-60VUC

2CDC 292 043 F0013

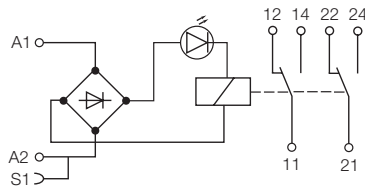



RB(R)122G-115VUC/230VUC

2CDC 292 044 F0013

Boxed interface relays R600 range

Technical data

		RB(R)101R-		RB(R)111R-	
		24VUC		24VUC	
Input circuit					
Rated control supply voltage U_s		24 V AC/DC			
Rated control supply voltage U_s tolerance	DC	-15 %, +20 %			
	AC	-/+ 10 %			
Rated frequency		50/60 Hz			
Typical power consumption		0.24 W			
Typical current		10 mA			
Drop-out voltage	at 20 °C	4.5 V			
Indication of operational states	green LED	 l: control supply voltage applied			
Output circuit					
Kind of output	11-12	relay, 1 n/c contact		-	
	13-14	-		relay, 1 n/o contact	
Rated operational voltage U_o		250 V AC			
Minimum switching voltage		12 V			
Maximum switching voltage		250 V AC			
Minimum switching current		10 mA			
Rated free air thermal current I_{th}		6 A			
Rated operational current I_e	AC-12 (resistive) 230 V	6 A			
	AC-15 (inductive) 230 V	1.5 A			
	AC-15 (inductive) 120 V	3 A			
	DC-12 (resistive) 24 V	6 A			
	DC-13 (inductive) 24 V	1 A			
	DC-13 (inductive) 110 V	0.2 A			
	DC-13 (inductive) 220 V	0.1 A			
AC rating (UL 508; NEMA ICS-5)	utilization category (pilot duty)	B300			
DC rating (UL 508; NEMA ICS-5)	utilization category (pilot duty)	R300			
Minimum switching power		0.6 W / 0.6 VA			
Mechanical lifetime		1 x 10 ⁷ switching cycles			
Electrical lifetime	at AC-15	1 x 10 ⁵ switching cycles			
Max. fuse rating to achieve short-circuit protection		6 A fast			
Response time		5 ms			
Release time		8 ms			
		24VUC		RB(R)111-	
		24VUC		115VUC	
		24VUC		230VUC	
Input circuit					
Rated control supply voltage U_s		24 V AC/DC		115 V AC/DC	
Rated control supply voltage U_s tolerance	DC	-15 %, +20 %		-15 %, +10 %	
	AC	-/+ 10 %			
Rated frequency		50/60 Hz			
Typical power consumption		0.24 W		0.46 W	
Typical current		10 mA		4 mA	
Drop-out voltage	at 20 °C	4.5 V		17 V	
Indication of operational states	green LED	 l: control supply voltage applied			
Output circuit					
Kind of output	13-14	relay, 1 n/o contact			
Rated operational voltage U_o		250 V AC			
Minimum switching voltage		12 V			
Maximum switching voltage		250 V AC			
Minimum switching current		10 mA			
Rated free air thermal current I_{th}		6 A			
Rated operational current I_e	AC-12 (resistive) 230 V	6 A			
	AC-15 (inductive) 230 V	1.5 A			
	AC-15 (inductive) 120 V	3 A			
	DC-12 (resistive) 24 V	6 A			
	DC-13 (inductive) 24 V	1 A			
	DC-13 (inductive) 110 V	0.2 A			
	DC-13 (inductive) 220 V	0.1 A			
AC rating (UL 508; NEMA ICS-5)	utilization category (pilot duty)	B300			
DC rating (UL 508; NEMA ICS-5)	utilization category (pilot duty)	R300			
Minimum switching power		0.6 W / 0.6 VA			
Mechanical lifetime		1 x 10 ⁷ switching cycles			
Electrical lifetime	at AC-15	1 x 10 ⁵ switching cycles			
Max. fuse rating to achieve short-circuit protection		6 A fast			
Response time		5 ms		6 ms	
Release time		8 ms		15 ms	

Boxed interface relays R600 range

Technical data

	RB(R)121(P)(G)-								
	5VDC	12VDC	24VDC	24VUC	48-60VUC	115VUC	230VUC		
Input circuit									
Rated control supply voltage U_s	5 V DC	12 V DC	24 V DC	24 V AC/DC	48 V AC/DC	60 V AC/DC	115 V AC/DC	230 V AC/DC	
Rated control supply voltage U_s tolerance	DC -15 %, +20 %	AC -/+ 10 %							
Rated frequency	-				50/60 Hz				
Typical power consumption	0,2 W	0,2 W	0,24 W			0,33 W	0,54 W	0,46 W	0,8 W
Typical current	40 mA	16 mA	10 mA			7 mA	9 mA	4 mA	3,5 mA
Drop-out voltage at 20 °C	1,2 V	2,2 V	4,5 V			8 V	8 V	17 V	27 V
Indication of operational states	green LED	┌: control supply voltage applied							
Output circuit									
Kind of output	11-12/14	relay, 1 c/o (SPDT) contact							
Rated operational voltage U_e	250 V AC								
Minimum switching voltage	12 V / gold-plated contacts: 5 V								
Maximum switching voltage	250 V AC								
Minimum switching current	10 mA / gold-plated contacts: 3 mA at 20 V								
Rated free air thermal current I_{th}	6 A								
Rated operational current I_e	AC-12 (resistive) 230 V	6 A							
	AC-15 (inductive) 230 V	1,5 A							
	AC-15 (inductive) 120 V	3 A							
	DC-12 (resistive) 24 V	6 A							
	DC-13 (inductive) 24 V	1 A							
	DC-13 (inductive) 110 V	0,2 A							
	DC-13 (inductive) 220 V	0,1 A							
AC rating (UL 508; NEMA ICS-5)	utilization category (pilot duty)	B300							
DC rating (UL 508; NEMA ICS-5)	utilization category (pilot duty)	R300							
Minimum switching power	0,6 W / 0,6 VA; gold plated contacts: 0,06 V / 0,06 VA								
Mechanical lifetime	1 x 10 ⁷ switching cycles								
Electrical lifetime at AC-15	1 x 10 ⁵ switching cycles								
Max. fuse rating to achieve short-circuit protection	6 A fast								
Response time	5 ms	5 ms	5 ms			5 ms	5 ms	6 ms	7 ms
Release time	8 ms	8 ms	8 ms			8 ms	8 ms	15 ms	16 ms

	RB(R)121R-	
	115VUC	230VUC
Input circuit		
Rated control supply voltage U_s	115 V AC/DC	230 V AC/DC
Rated control supply voltage U_s tolerance	DC -20%, +15%	AC -10%, +15%
Rated frequency	50/60 Hz	
Typical power consumption	2 W	2,8 W
Typical current	18 mA	12 mA
Drop-out voltage at 20 °C	17 V	27 V
Indication of operational states	green LED	┌: control supply voltage applied
Output circuit		
Kind of output	11-12/14	relay, 1 c/o (SPDT) contact
Rated operational voltage U_e	250 V AC	
Minimum switching voltage	12 V	
Maximum switching voltage	250 V AC	
Minimum switching current	10 mA	
Rated free air thermal current I_{th}	6 A	
Rated operational current I_e	AC-12 (resistive) 230 V	6 A
	AC-15 (inductive) 230 V	1,5 A
	AC-15 (inductive) 120 V	3 A
	DC-12 (resistive) 24 V	6 A
	DC-13 (inductive) 24 V	1 A
	DC-13 (inductive) 110 V	0,2 A
	DC-13 (inductive) 220 V	0,1 A
AC rating (UL 508; NEMA ICS-5)	utilization category (pilot duty)	B300
DC rating (UL 508; NEMA ICS-5)	utilization category (pilot duty)	R300
Minimum switching power	0,6 W / 0,6 VA	
Mechanical lifetime	1 x 10 ⁷ switching cycles	
Electrical lifetime at AC-15	1 x 10 ⁵ switching cycles	
Max. fuse rating to achieve short-circuit protection	6 A fast	
Response time	6 ms	7 ms
Release time	15 ms	16 ms

Boxed interface relays R600 range

Technical data

	RB(R)122G				
	24 V UC	48-60 V UC	60 V UC	115 V UC	230 V UC
Input circuit					
Rated control supply voltage U_s	24 V AC/DC	48 V AC/DC	60 V AC/DC	115 V AC/DC	230 V AC/DC
Rated control supply voltage U_s tolerance	DC -15 %, +20 % AC -/+ 10 %				-15 %, +10 %
Rated frequency	50/60 Hz				
Typical power consumption	0.48 W	0.62 W	0.96 W	0.58 W	1.15 W
Typical current	20 mA	13 mA	16 mA	5 mA	5 mA
Drop-out at 20 °C	5.4 V	8.8 V	8.8 V	20 V	10 V
Indication of operational states	green LED	┌: control supply voltage applied			
Output circuit					
Kind of output	11-12/14 21-22/24	relay, 1st c/o (SPDT) contact relay, 2nd c/o (SPDT) contact			
Rated operational voltage U_o	250 V AC				
Minimum switching voltage	5 V				
Maximum switching voltage	250 V DC - 250 V AC				
Minimum switching current	1 mA				
Rated free air thermal current I_{th}	8 A				
Rated operational current I_o	AC-12 (resistive) 230 V AC-15 (inductive) 230 V DC-12 (resistive) 24 V DC-13 (inductive) 24 V DC-13 (inductive) 110 V DC-13 (inductive) 220 V	8 A 1.5 A 8 A 1 A 0.2 A 0.1 A			
Minimum switching power	5 mW / 5 mVA				
Mechanical lifetime	2 x 10 ⁷ switching cycles				
Electrical lifetime at AC-15	1 x 10 ³ switching cycles				
Max. fuse rating to achieve short-circuit protection	10 A fast				
Response time	6 ms	10 ms	10 ms	6 ms	6 ms
Release time	10 ms	14 ms	14 ms	15 ms	15 ms

General technical data - Interface relays

	RB	RBR
General data		
Material of housing	UL 94 V0	
Mounting	DIN rail	
Degree of protection	housing / terminals	IP20 NEMA1
Electrical connection		
	Screw terminal	Spring-type terminal
Connecting capacity	fine-strand 0.22-2.5 mm ² (24-14 AWG) rigid 0.2-4 mm ² (24-12 AWG)	0.2-2.5 mm ² (24-14 AWG)
Stripping length	9 mm (0.354 in)	
Tightening torque	0.4-0.6 Nm (3.5-5.3 lb.in)	
Environmental data		
Ambient temperature ranges	storage -40...+80 °C (-40...+176 °F) operation -20...+70 °C (-4...+158 °F) ¹⁾	
Isolation data		
Rated insulation voltage U_i	250 V	
Rated impulse withstand voltage U_{imp}	input / output 4 kV shock coil / output 4 kV output / output 1 kV	
Overvoltage category	III	
Pollution degree	2	
Standards/Directives		
Standards	IEC/EN 60947-5-1	
Low Voltage Directive	2014/35/EC	
RoHS Directive	2011/65/EC	

¹⁾ Over 55 °C, blocks have to be mounted on horizontal rail with 10 mm spacing between each block. For vertical rail mounting max. operation temperature is 15 °C lower.

Boxed interface relays R600 range

Load limit curves, Dimensional drawings

Load limit curves

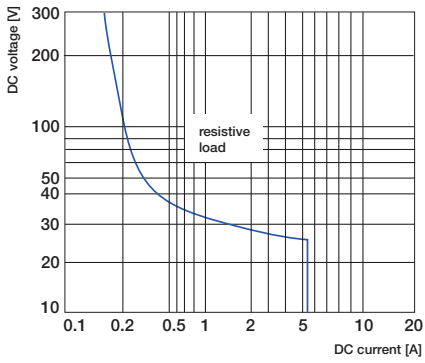

Versions with 1 n/o, 1 n/c or 1 c/o contact

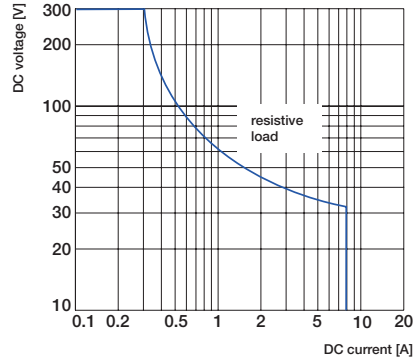

Versions with 2 c/o contacts

5

Dimensions

in mm and inches

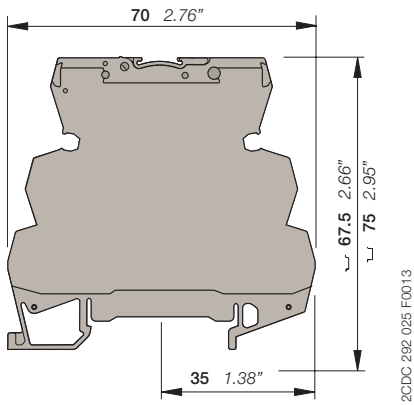

Versions with screw terminals

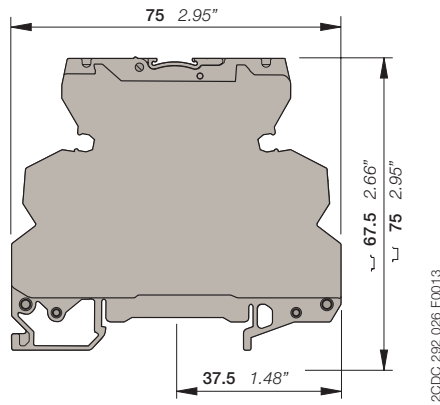

Versions with spring-type terminals

Boxed interface relays R600 range

Notes

Boxed optocouplers R600 range

Ordering details



R600 - 6 mm

2CDC291 024 S0013



R600 - 12 mm

2CDC291 013 S0013

Transistor output, 58 V DC, 100 mA, width 6 mm

Rated control supply voltage	Connection type	Type	Order code	Pkg qty	Weight (1 pc) kg (lb)
5 - 12 V DC	Screw	OBIC0100-5-12VDC	1SNA645047R0000	10	0.02 (0.044)
24 V DC	Screw	OBIC0100-24VDC	1SNA645021R2600		
48 - 60 V AC/DC	Screw	OBIC0100-48-60VUC	1SNA645049R1200		
115 - 230 V AC/DC	Screw	OBIC0100-115-230	1SNA645022R2700		
5 - 12 V DC	Spring	OBRIC0100-5-12VDC	1SNA645547R0200	10	0.02 (0.044)
24 V DC	Spring	OBRIC0100-24VDC	1SNA645521R2000		
48 - 60 V AC/DC	Spring	OBRIC0100-48-60VUC	1SNA645549R1400		
115 - 230 V AC/DC	Spring	OBRIC0100-115-230	1SNA645522R2100		

MOS-FET output, 58 V DC, 2 A, width 6 mm

Rated control supply voltage	Connection type	Type	Order code	Pkg qty	Weight (1 pc) kg (lb)
5 - 12 V DC	Screw	OBOC2000-5-12VDC	1SNA645050R1700	10	0.02 (0.044)
24 V DC	Screw	OBOC2000-24VDC	1SNA645051R0400		
24 V AC/DC	Screw	OBOC2000-24VUC	1SNA645025R2200		
48 - 60 V AC/DC	Screw	OBOC2000-48-60VUC	1SNA645053R0600		
115 V AC/DC	Screw	OBOC2000-115VUC	1SNA645054R0700		
230 V AC/DC	Screw	OBOC2000-230VUC	1SNA645026R2300	10	0.02 (0.044)
5 - 12 V DC	Spring	OBROC2000-5-12VDC	1SNA645550R1100		
24 V DC	Spring	OBROC2000-24VDC	1SNA645551R0600		
24 V AC/DC	Spring	OBROC2000-24VUC	1SNA645525R2400		
48 - 60 V AC/DC	Spring	OBROC2000-48-60VUC	1SNA645553R0000		
230 V AC/DC	Spring	OBROC2000-230VUC	1SNA645526R2500		

MOS-FET output, 58 V DC, 5 A, width 6 mm

Rated control supply voltage	Connection type	Type	Order code	Pkg qty	Weight (1 pc) kg (lb)
24 V DC	Screw	OBOC5000-24VDC	1SNA645024R2100	10	0.02 (0.044)
115 V AC/DC	Screw	OBOC5000-115VUC	1SNA645058R1300		
24 V DC	Spring	OBROC5000-24VDC	1SNA645524R2300	10	0.02 (0.044)
230 V AC/DC	Spring	OBROC5000-230VUC	1SNA645559R1600		

Triac output, 400 V AC, 1 A, width 6 mm

Rated control supply voltage	Connection type	Type	Order code	Pkg qty	Weight (1 pc) kg (lb)
24 V DC	Screw	OBOA1000-24VDC	1SNA645027R2400	10	0.03 (0.066)
115 V AC/DC	Screw	OBOA1000-115VUC	1SNA645062R0700		
230 V AC/DC	Screw	OBOA1000-230VUC	1SNA645028R0500		
24 V DC	Spring	OBROA1000-24VDC	1SNA645527R2600	10	

Triac output, 230 V AC, 2 A, width 12 mm

Rated control supply voltage	Connection type	Type	Order code	Pkg qty	Weight (1 pc) kg (lb)
24 V DC	Screw	OBOA2000-24VDC	1SNA645029R0600	5	0.03 (0.066)
24 V DC	Spring	OBROA2000-24VDC	1SNA645529R0000	5	

Ordering details - Accessories

Description	Type	Order code	Pkg qty	Weight (1 pc) kg (lb)
Jumper bar, 10 poles * (replacement of BJ612-10 - 1SNA290488R0100)	RB-JB10	1SVR406570R0000	10	0.05 (0.11)
Jumper bar, 20 poles * (replacement of BJ612-20 - 1SNA206754R0000)	RB-JB20	1SVR406580R0000		0.10 (0.22)
Separator end section	SC612	1SNA290474R0200		0.05 (0.11)
Front marking blank cards, 100 pcs.	RC610	1SNA233000R0100		
Terminal marking blank cards, 100 pcs.	RC65	1SNA232000R0000		

* - Before the first and after the last jumpered R600 optocoupler, a separator end section shall be used.

- The sum of the current for jumpered devices shall not exceed 6 A on 6 mm devices and 8 A on 12 mm devices.

Boxed interface R600 range

Connection diagrams

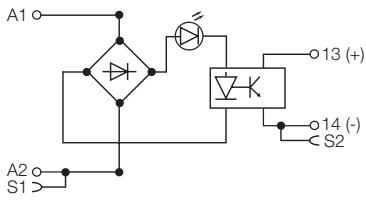

OB(R)OC, OB(R)IC
except 5-12VDC versions

2CDC 292.019 F0016

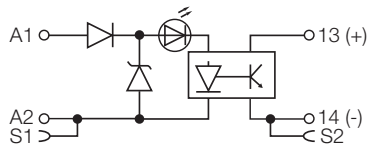

OB(R)IC0100-5-12VDC
OB(R)OC2000-5-12VDC

2CDC 292.017 F0016

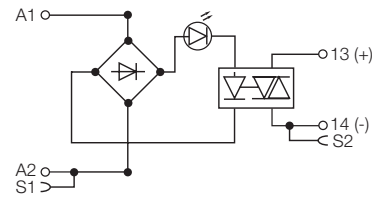

OB(R)OA

2CDC 292.018 F0016

Boxed optocouplers R600 range

Technical data

	OB(R)IC0100-...						
	5-12 V DC		24 V DC	48-60 V UC		115-230	
Input circuit							
Input voltage	5 V DC	12 V DC	24 V DC	48 V AC/DC	60 V AC/DC	115 V AC/DC	230 V AC/DC
Frequency	-			50/60 Hz			
Input current	5 mA	9 mA	4 mA	4 mA	5 mA	7 mA (AC) 16 mA (DC)	11.5 mA (AC) 25 mA (DC)
Pull-in voltage	4 V		15 V	25 V		60 V AC / 70 V DC	
Typ. switch-on time	10 µs			5 ms			
Typ. switch-off time	500 µs			20 ms			
Operating frequency	1000 Hz			20 Hz			
Permissible leakage current	0.9 mA		1.0 mA	0.9 mA		1.6 mA	
Output circuit							
11(13+)- 14							
Kind of output	Transistor						
Rated operational voltage	4.5-58 V DC						
Minimum switching current	1 mA						
Maximum switching current	100 mA						
Leakage current at max. switching voltage	< 50 µA						
Rated operational current I _e	DC-12 (resistive) 58 V 0.1 A						
Residual voltage	typical 1 V maximum 1.3 V						
Max. fuse rating to achieve short-circuit protection	100 mA fast						
Isolation data							
Rated insulation voltage U _i	250 V						
Rated impulse withstand voltage U _{imp}	2.5 kV						
Overvoltage category	II						
Pollution degree	2						

	OB(R)OC2000-...							
	5-12 V DC		24 V DC	24 V UC	48-60 V UC		115 V UC	230 V UC
Input circuit								
Input voltage	5 V DC	12 V DC	24 V DC	24 V AC/DC	48 V AC/DC	60 V AC/DC	115 V AC/DC	230 V AC/DC
Frequency	-			50/60 Hz				
Input current	5 mA	9 mA	5.4 mA	6.3 mA	4 mA	5.1 mA	4.2 mA	4 mA
Pull-in voltage	4 V		12 V	15 V	27 V	50 V	80 V	
Typ. switch-on time	15 µs		30 µs	1 ms	5 ms	500 µs	1 ms	
Typ. switch-off time	250 µs		400 µs	7 ms	20 ms	10 ms	15 ms	
Operating frequency	2000 Hz		1000 Hz	60 Hz	20 Hz	50 Hz	35 Hz	
Permissible leakage current	1 mA		0.8 mA	0.9 mA	1 mA	0.3 mA		
Output circuit								
11(13+)- 14								
Kind of output	MOS-FET							
Rated operational voltage	4.5-58 V DC							
Minimum switching current	1 mA							
Maximum switching current	2 A							
Leakage current at max. switching voltage	< 50 µA							
Rated operational current I _e	DC-12 (resistive) 58 V 2 A							
Residual voltage	typical 0.1 V maximum 0.5 V							
Max. fuse rating to achieve short-circuit protection	2 A ultra-fast							
Isolation data								
Rated insulation voltage U _i	250 V							
Rated impulse withstand voltage U _{imp}	2.5 kV							
Overvoltage category	II							
Pollution degree	2							

Boxed optocouplers R600 range

Technical data

	OB(R)OC5000-...		
	24VDC	115VUC	230VUC
Input circuit			
Input voltage	24 V DC	115 V AC/DC	230 V AC/DC
Frequency	-	50/60 Hz	-
Input current	5.4 mA	4.2 mA	4 mA
Pull-in voltage	12 V	50 V	80 V
Typ. switch-on time	30 µs	500 µs	1 ms
Typ. switch-off time	400 µs	10 ms	15 ms
Operating frequency	1000 Hz	50 Hz	35 Hz
Permissible leakage current	0.8 mA	0.3 mA	0.3 mA
Output circuit			
	11(13+)- 14		
Kind of output	MOS-FET		
Rated operational voltage	4.5-58 V DC		
Minimum switching current	1 mA		
Maximum switching current	5 A		
Leakage current at max. switching voltage	< 50 µA		
Rated operational current I _o	5 A		
	DC-12 (resistive) 58 V	5 A	
Residual voltage	typical	0.1 V	
	maximum	0.5 V	
Max. fuse rating to achieve short-circuit protection	6 A ultra-fast		
Isolation data			
Rated insulation voltage U _i	250 V		
Rated impulse withstand voltage U _{imp}	2.5 kV		
Overvoltage category	II		
Pollution degree	2		

5

	OB(R)OA1000-...			OB(R)OA2000-...
	24VDC	115VUC	230VUC	24VDC
Input circuit				
Input voltage	24 V DC	115 V AC/DC	230 V AC/DC	24 V DC
Frequency	-	50/60 Hz	-	-
Input current	3.6 mA	4.15 mA	4.6 mA	3.6 mA
Pull-in voltage	14 V	60 V	135 V	14 V
Typ. switch-on time	150 µs	2.2 ms	2.5 ms	150 µs
Typ. switch-off time	1 ms	18 ms	25 ms	1 ms
Operating frequency	500 Hz	25 Hz	20 Hz	500 Hz
Permissible leakage current	1 mA	-	-	1 mA
Output circuit				
	11(13+)- 14			
Kind of output	Triac			Triac
Rated operational voltage	24-400 V AC			10-230 V AC
Minimum switching current	25 mA			25 mA
Maximum switching current	1 A			2 A
Leakage current at max. switching voltage	< 500 µA			< 500 µA
Rated operational current I _o	1 A			-
	AC-12 (resistive) 400 V	AC-12 (resistive) 230 V		2A
Residual voltage	typical	1 V		
	maximum	1.6 V		
Max. fuse rating to achieve short-circuit protection	4 A ultra-fast			4 A ultra-fast
Isolation data				
Rated insulation voltage U _i	400 V			230 V
Rated impulse withstand voltage U _{imp}	4 kV			4 kV
Overvoltage category	II			II
Pollution degree	2			2

Boxed optocouplers R600 range

Technical data, Dimensional drawings

General technical data - Optocouplers

		OB	OBR
General data			
Material of housing		UL 94 V0	
Mounting		DIN Rail	
Degree of protection	housing / terminals	IP20 NEMA1	
Electrical connection		Screw terminal	Spring-type terminal
Connecting capacity	fine-strand	0.22-2.5 mm ² (24-14 AWG)	
	rigid	0.2-4 mm ² (24-12 AWG)	0.2-2.5 mm ² (24-14 AWG)
Stripping length		9 mm (0.354 in)	
Tightening torque		0.4-0.6 Nm (3.5-5.3 lb.in)	n/a
Environmental data			
Ambient temperature ranges	storage	-40...+80 °C (-40...+176 °F)	
	operation	-20...+70 °C (-4...+158 °F)	
Standards/Directives			
Standards		IEC/EN 60947-5-1	
Low Voltage Directive		2014/35/EU	
RoHS Directive		2011/65/EU	

5

Dimensions

in mm and inches

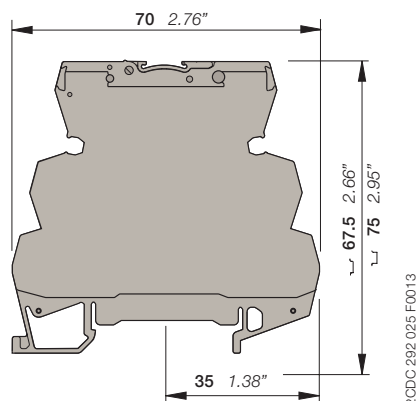

Versions with screw terminals

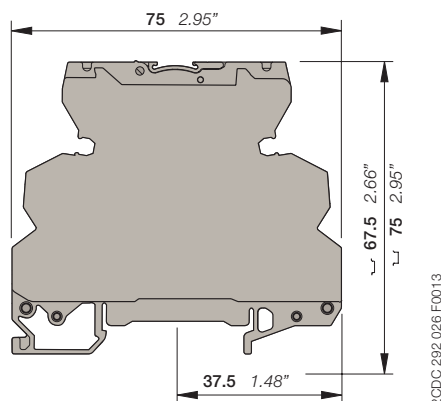

Versions with spring-type terminals